



Section 5:

Dryer Parts Data

SWD

Dryer Cabinet Group

	Description	T-50SWD-11 Reversing	QTY
1	Panel Assy., Front- Upper (SS)	9989-580-001	1
*	Insulation Front Panel, half moon (top)	9277-054-001	1
*	Insulation Front Panel, half moon (bottom)	9277-054-002	1
2	Screw, FLHDCR, 10B x 1	9545-008-014	4
3	Washer, Finish, #10	8641-585-001	4
*	Nut, Spring	8640-399-001	4
*	Hinge ,Backup Plate	9982-356-001	1
*	Screw, Countersink, 10-32X 1/2	9545-012-003	1
4	Strap, Hinge (SS/Black)	9544-069-005	2
*	Screw, Hinge to Panel	9545-012-028	8
*	Door Assy., Loading Complete-SS	9960-285-011	1
*	Door Assy., Loading Complete-Chrome/BLK/SS	9960-285-007	1
5	Door Assy., Loading-SS(ring only)	9960-284-002	1
5	Door Assy., Loading-Chrome(ring only)	9960-284-004	1
6	Plate Assy., Hinge (SS)	9982-353-001	1
*	Screw, Hinge to Door	9545-012-015	4
*	Nut, Hinge to Door	8640-413-002	4
*	Cover, Hinge Plate	9074-340-002	1
*	Screw, Phillips-10B x 3/8	9545-008-010	2
7	Glass, Door	9212-002-004	1
8	Gasket, Glass Black	9206-413-002	1
*	Support, Door Glass	9548-117-000	1
*	Tool Install Dryer Door Gasket	8545-064-001	1
9	Gasket, Outer Rim Black	9206-420-005	1
10	Handle, Loading Door	9244-093-001	1
*	Screw, Handle 1/4-20 x 3/8	9545-018-017	2
11	Stud, Door Catch, 7/8	9531-033-003	1
12	Nut, Hex	8640-413-001	1
13	Nut, Acorn	8640-413-003	1
14	Catch, Loading Door	9086-015-002	1
15	Pop Rivet for mtg. catch	8638-190-009	2
16	Screw, Door to Hinge Strap (Special Black Type)	9545-052-001	1
17	Washer, Fiber	8641-436-003	1
18	Acceptor, Coin	9021-094-001	1
*	Retainer, Coin Acceptor	9486-149-001	2
19	Screw, 4Bx5/8ss, T10	9545-053-002	4
*	Switch, Optical	9801-099-001	1
*	Cabinet Touch Up Paint (White)	9472-001-013	1

Cabinet Group

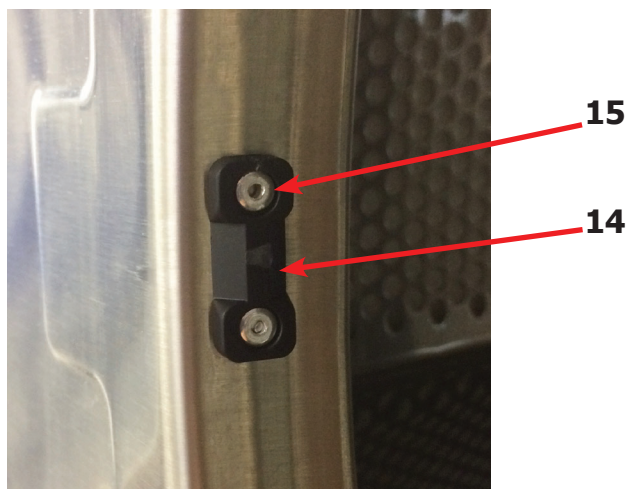
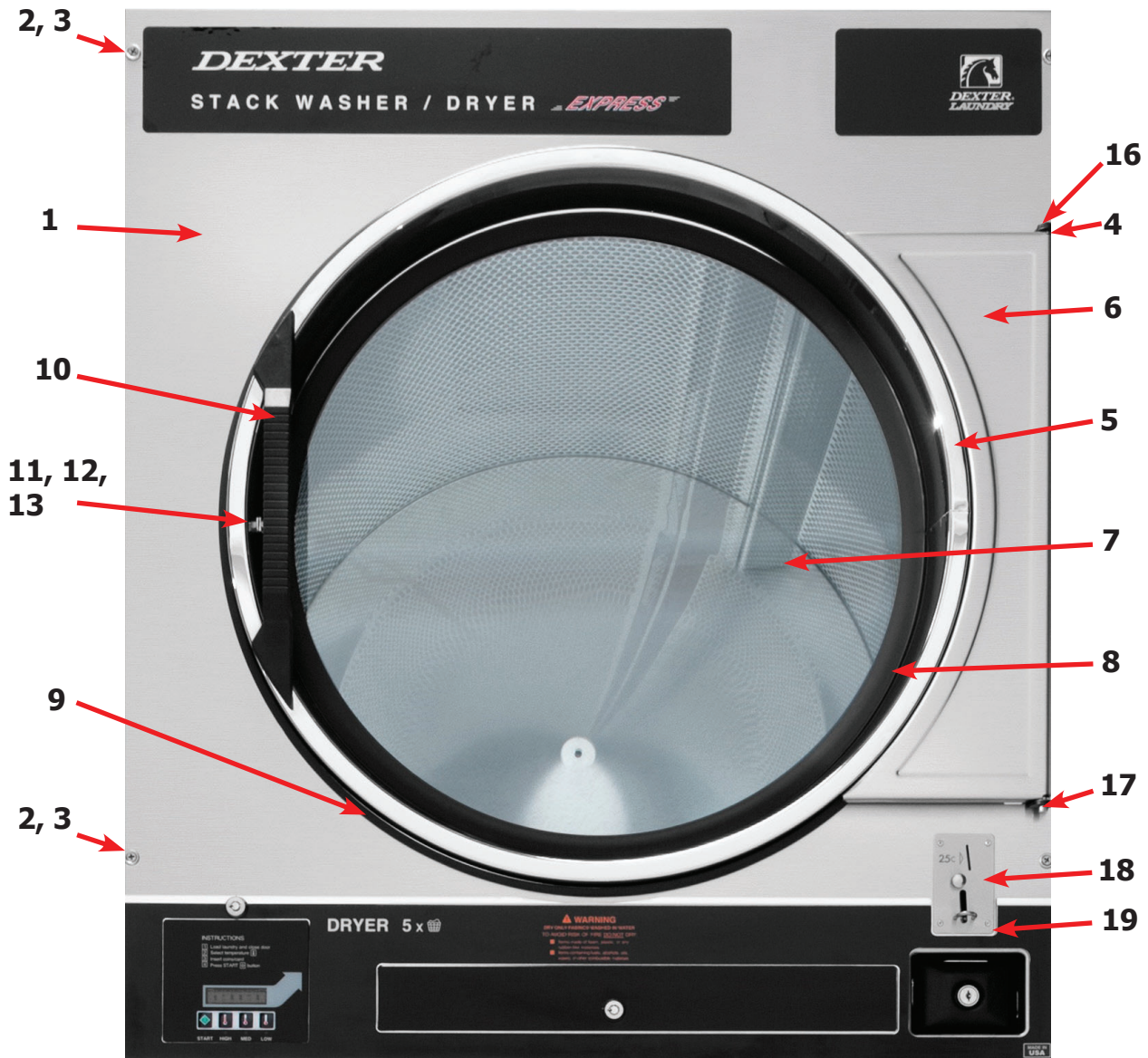

Dryer Cabinet Group

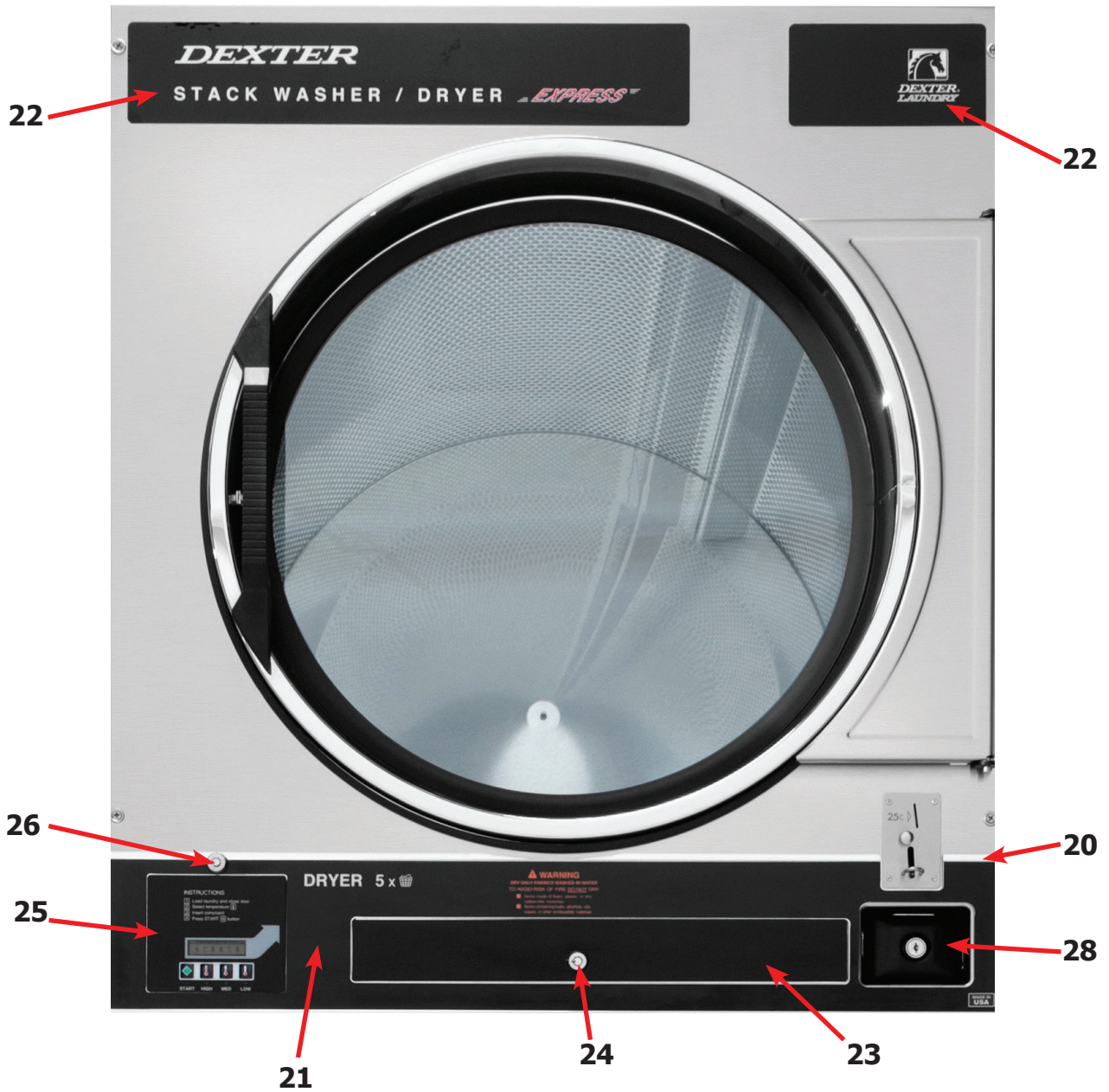

Cabinet Group Continued

Key	Description	T-50 SWD-11 Reversing	QTY
20	Escutcheon, SWD, Dryer Coin	9994-036-001	1
21	Trim, Overlay Blue	9435-048-002	1
21	Trim, Overlay Black	9435-048-001	1
*	Screw, #4-40 x 3/16	9545-020-009	13
22	Nameplate Stack Dryer Express Blue	9412-202-002	1
22	Nameplate Stack Dryer Express Black	9412-202-001	1
*	Lint Drawer Assembly Blue	9866-007-001	1
*	Lint Drawer Assembly Black	9866-007-003	1
*	Drawer, Front PTD	9974-015-002	1
*	Washer, Flat, #10	8641-581-006	2
*	Washer, Curved-Spring	8641-569-004	2
*	Nut, 10-32	8640-413-007	22
23	Overlay Trim, Lint Drwr-Blue	9435-024-001	1
23	Overlay Trim, Lint Drwr-Black	9435-032-001	1
*	Felt Seal (back of lint screen assembly)	9532-074-003	1
*	Lint Screen Assembly ONLY (no front)	9805-033-002	1
*	Replaceable Lint Screen Only	9555-057-008	1
24	Lock and Key, Lint Drawer	8650-012-004	1
*	Key 6101 only	6292-006-010	1
*	Cam, Lock	9095-043-001	1
*	Lint Screen Strap Hold Down Screws 10Bx 1/4	9545-008-001	32
25	Controls Assy, 24VAC, Blue	9857-199-002	1
25	Controls Assy, 24VAC, Black	9857-199-004	1
*	Harness, Electronic Control	9627-913-002	1
26	Lock and Key, Control	8650-012-003	1
*	Cam, Lock	9095-041-001	1
*	Key only 6324	6292-006-007	1
*	Harness, Heat Sensor	9627-913-002	1
*	Wire Nut Connector Grey	8640-276-002	4
27	Sensor Temp Control	9501-004-003	2
*	Bracket for Heat Sensor Mounting (Under Basket) w/ sensor	9501-008-001	2
*	Screw, Round Head (Mounts sensor; phillips head)	9545-045-005	2
*	Grommet, 3/16 ID	9209-037-002	2
*	Cover, Cabinet (Top)	9074-371-001	1
*	Insulation Cabinet Cover	9277-041-017	1
*	Stack Dryer Trunion Puller	9732-243-002	1
*	Vault, Coin Box	9942-027-015	1
*	Screws, Mounting-Coin Vault	9545-008-024	2
28	Coin Box Assy, Large Blue	9807-099-002	1
28	Coin Box Assy, Large Black	9807-099-004	1
*	Nut, Elastic Stop	8640-413-004	*

Door Switch Group

Key	Description	T-50X2-11 Reversing	QTY
1	Door Switches	9539-487-001	1

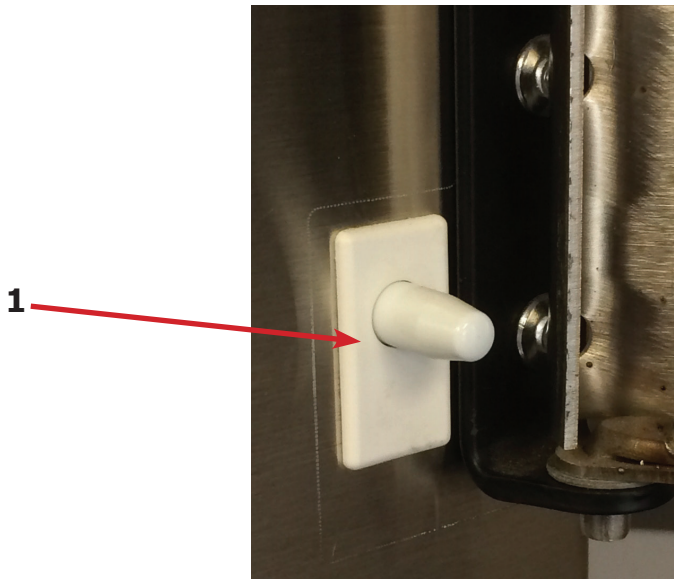

Hinge Plate Cover

Key	Description	T-50X2-11 Reversing	QTY
1	Cover-Hinge, Black	9074-340-002	1
2	Screw-TRHDCR, 10B x 3/8, Black	9545-008-010	2

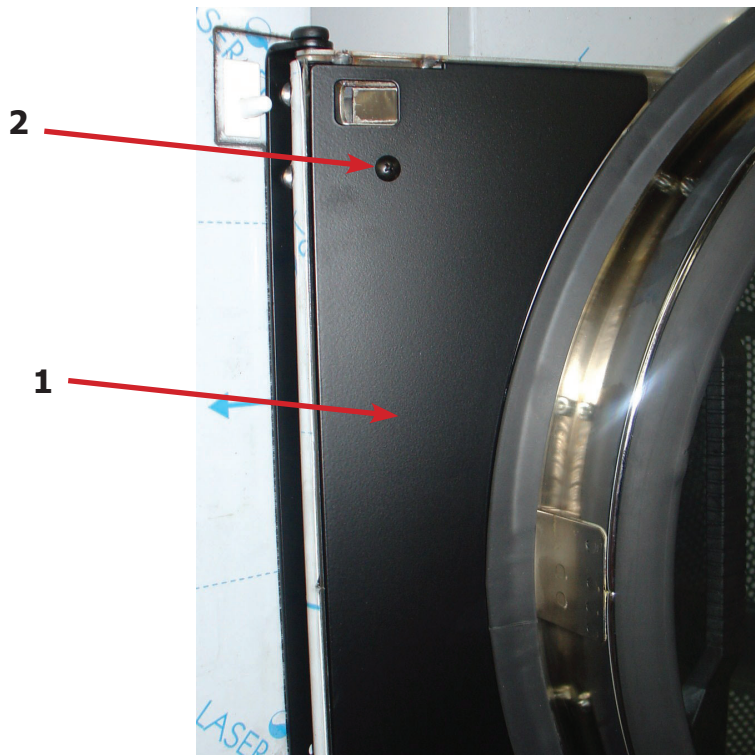

Sensor Assembly, Thermister

Key	Description	T-50X2-11 Reversing	QTY
*	Bracket for Heat Sensor Mounting (Under Basket) w/ sensor	9501-008-001	1
1	Bracket Assembly Thirmister	9985-188-001	1
2	gasket spacer	9206-176-000	1
3	Gromet	9209-037-002	1
4	Screw, 8B x 14	9545-045-005	1
5	Sensor-Heat, Thermister- 40K Ohm	9501-004-003	1
*	Screw-Mounting, 10AB x 3/8	9545-008-024	1

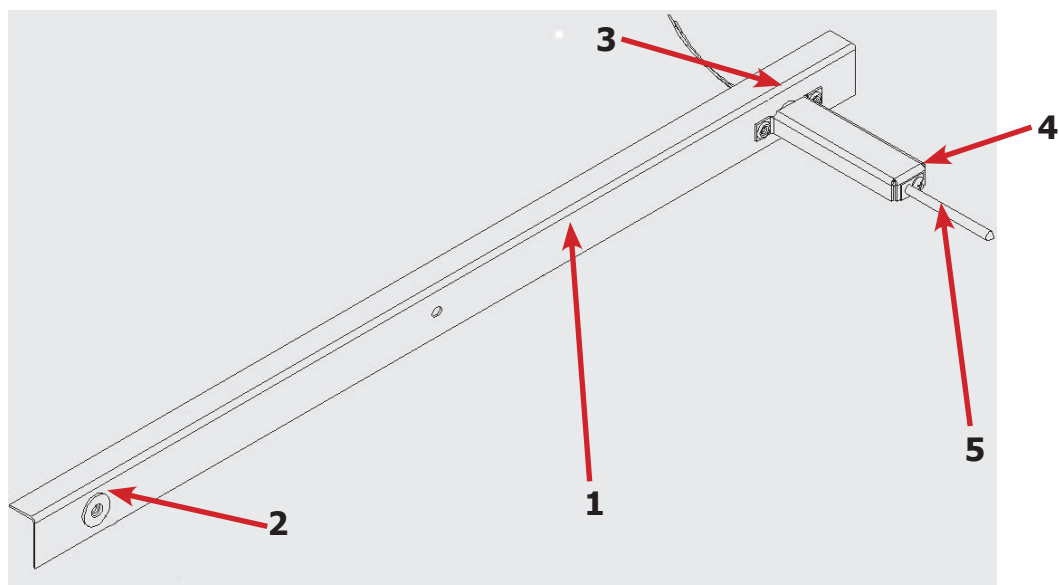

Dryer Back Panels and Guards

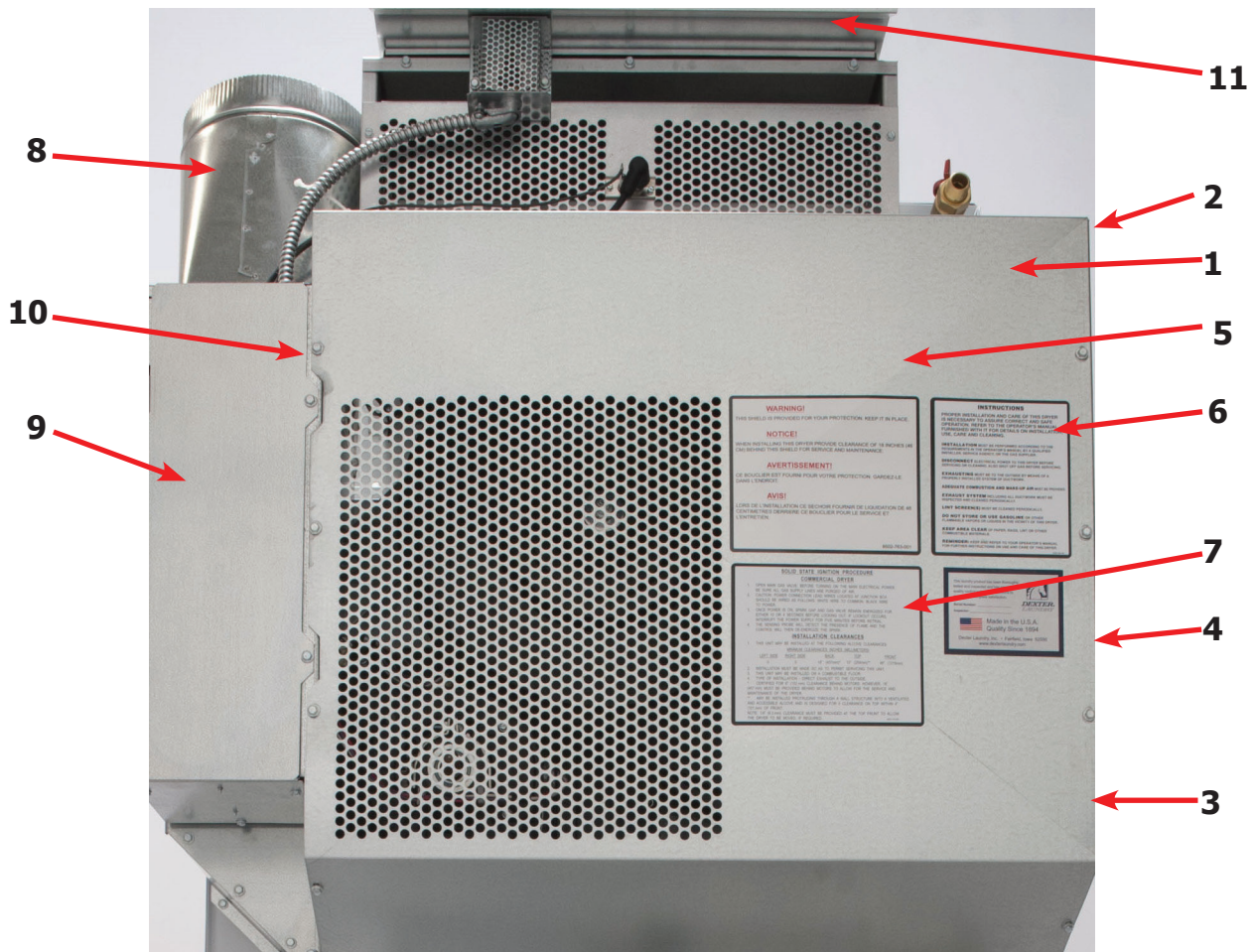

Key	Description	Part Number	Qty
1	Guard, Drive	9208-126-001	1
2	Panel, Drive Guard, RH, Upper	9208-127-001	1
3	Panel, Drive Guard, RH, Lower	9208-128-001	1
4	Screw, 10AB x 3/8	9545-008-024	8
5	Warning, Lable	8502-763-001	1
6	Lable, Instructions	8502-645-001	1
7	Lighting and Clearence, Label	8527-112-001	1
8	Duct, Transition	9109-113-001	1
9	Door, Cover-Control Box	9108-138-001	1
10	Screw, 10AB x 3/8	9545-008-024	3
*	Cabinet, Cover	9074-371-001	1
*	Insulation	9277-041-017	1
*	Screw, 10AB x 3/8	9545-008-024	3
11	Shield-Burner Inlet	9550-191-001	1
*	Screw, 10AB x 3/8	9545-008-024	4
*	Wiring Diagram & Schematic	9506-797-001	1
*	8" Slide Open Clean Out Duct (Optional)	9973-034-001	1

Air Flow Switch Assembly

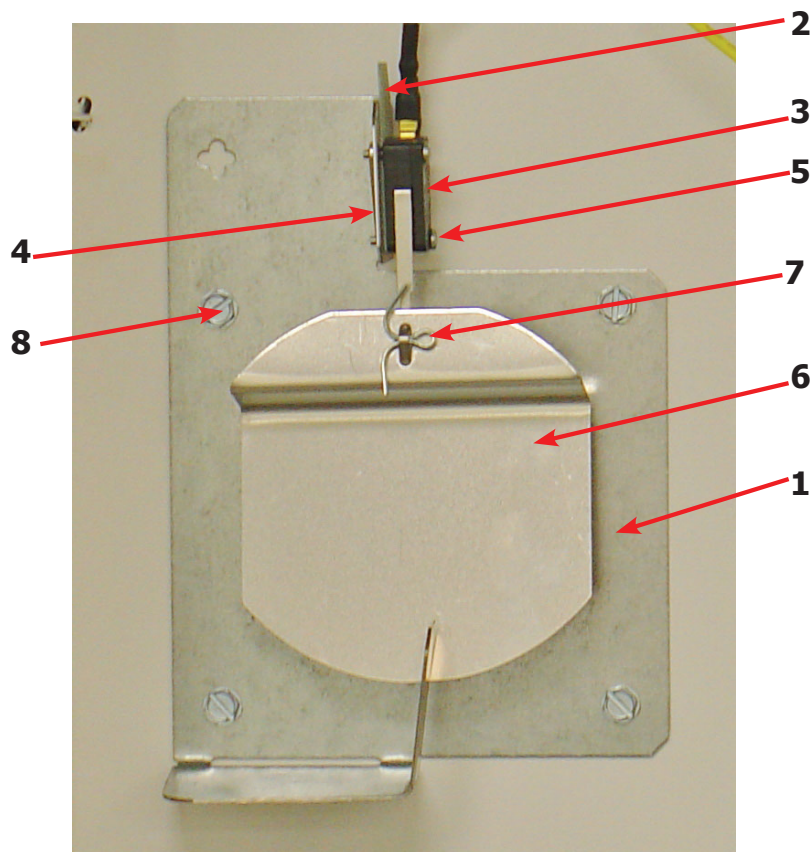

Key	Description	T-50X2-11 Reversing	QTY
*	Air Flow switch Assy	9801-098-001	2
1	Bracket-Airflow switch	9029-200-001	2
2	Shield-Switch	9550-169-003	2
3	Switch-Micro	9539-461-009	2
4	Nut-Twin, 4-40	8640-401-001	2
5	Screw-.625, 4-40	9545-020-001	2
6	Actuator-Air Flow Switch	9008-007-001	2
7	Pin-Cotter, .09375x.75	9451-169-002	2
8	Screw, 10AB x 3/8	9545-008-024	8
*	Harness Assembly, Overtemp/Airflow	9627-861-001	1

Dryer Burner Housing Group

Key	Description	T-50X2-11 Reversing	QTY
*	Housing Assembly, Burner	9803-207-001	1
1	Service Burner Plate Front	9452-730-001	1
2	Screw, 10B X 1/4"	9545-008-001	4
3	Service Plate baffle Recirculation Chamber Clean Out	9452-729-001	1
4	Screw, 10B x 3/8"	9545-008-006	6
5	Angle, Burner Support	9003-220-001	1
*	Screw, 10B x 3/8"	9545-008-006	2
6	Burner, Main	9048-020-002	2
*	Screw 10AB x 3/8"	9545-008-006	2
*	Panel, Back Burner Housing	9454-824-001	1
7	Electrode Assy, Ignition	9875-002-003	1
8	Screw, Electrode Mtg 8B x 1/4"	9545-045-001	2
9	Valve, Gas Shut Off (Optional)	9379-196-001	1
10	Pipe, 1/2 x 4 1/2, BLK	8655-073-044	1
11	Elbow, 1/2 x 90, BLK	8615-104-037	1
12	Nipple, 1/2 x 4 1/2, BLK	8665-073-008	1
13	Control Assy, Gas	9857-134-001	1
14	Manifold, Assy	9381-012-001	1
*	Orifice, Burner-Natural #29	9425-069-021	2
*	Orifice, Burner-LP #46	9425-069-022	2
15	Bracket, Manifold	9029-175-001	2
16	Pipe Plug in end of Burner Manifold	8615-104-038	1
*	Screw, 10B x 3/8"	9545-008-006	2
*	Bracket, High Limit Thermostat	9029-192-001	1
17	Thermostat, Hi-Limit	9576-203-002	2
*	Spacer, Hi-Limit	9538-142-001	1
*	Screw 8B x 3/4"	9545-045-007	2
18	Cover, Hi-Limit Stat	9074-329-001	1
*	Screw, 10B x 3/8"	9545-008-006	2
19	Thermostat, Safety Shutoff	9576-207-008	1
20	Screw, 10B x 3/8"	9545-008-006	3
21	Cover, Safety Stat	9825-062-001	2
*	Screw, 10AB x 3/8	9545-008-024	3
*	Control, Ignition Fenwall (3 trybox)	9857-182-001	1
*	Kit, LP Conversion 50Lb Stack Kit	9732-102-032	1
22	Heat Recirculation Duct, (From Exhaust to Burner	9973-032-001	2
*	Screw, 10B x 3/8"	9545-008-006	8
23	Shield-Burner Inlet	9550-188-001	1

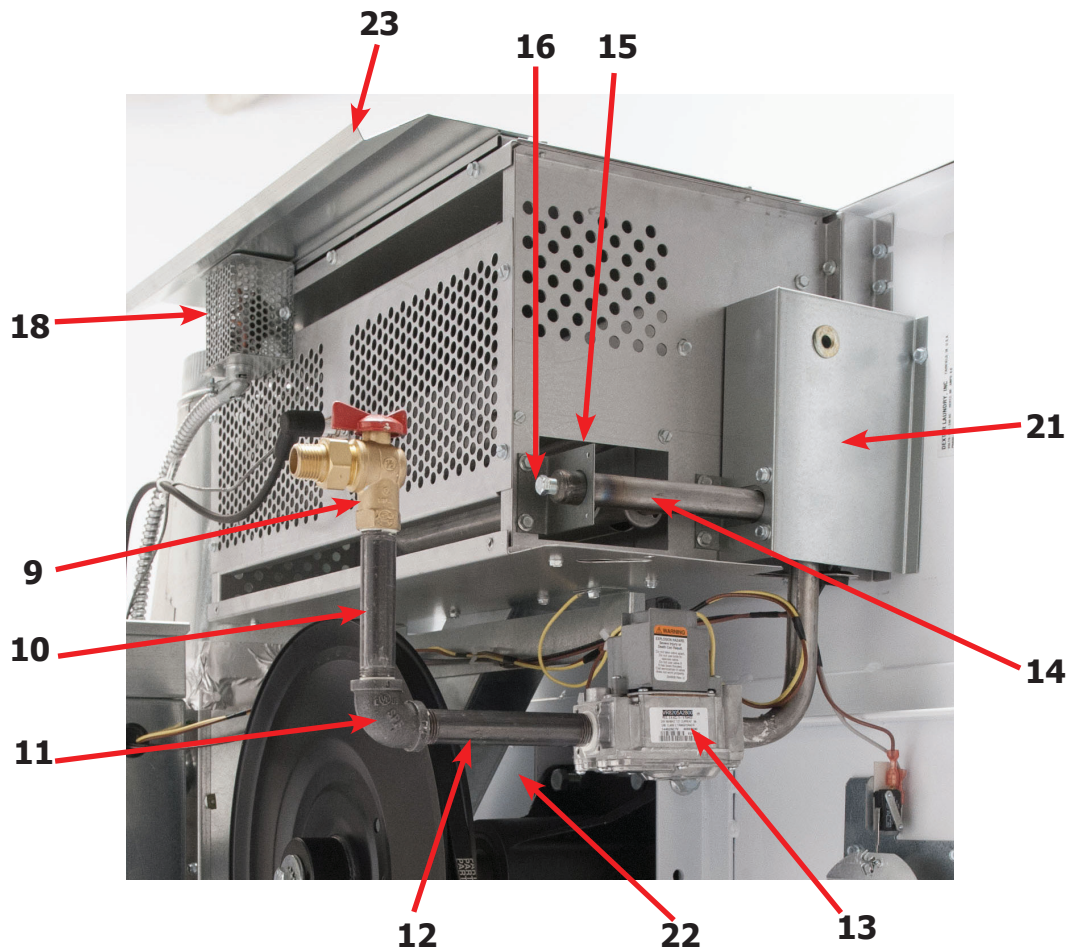
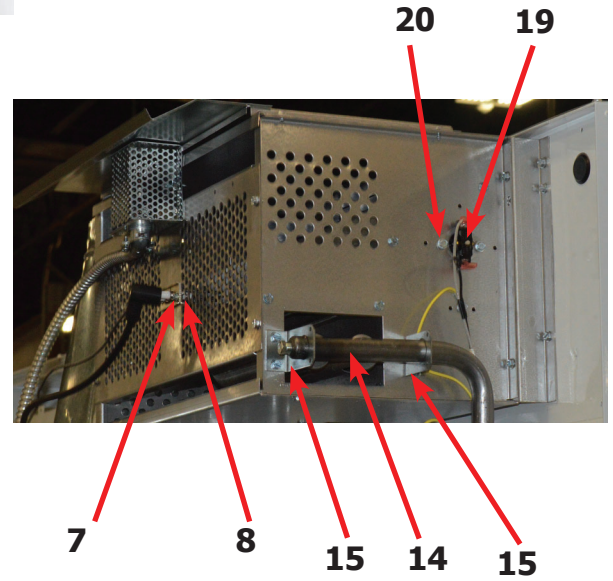
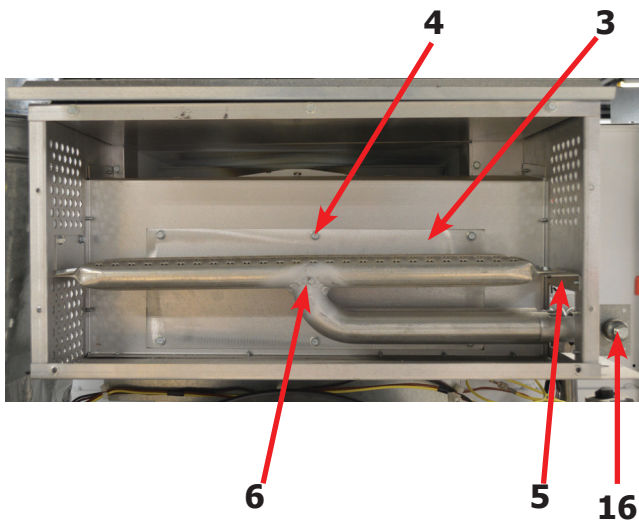
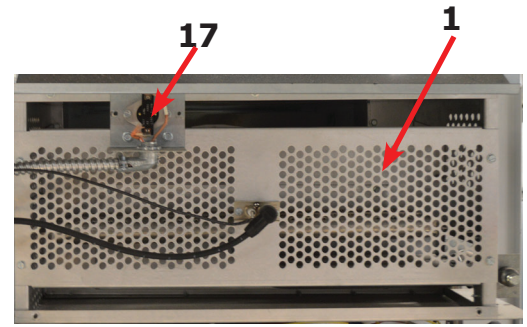
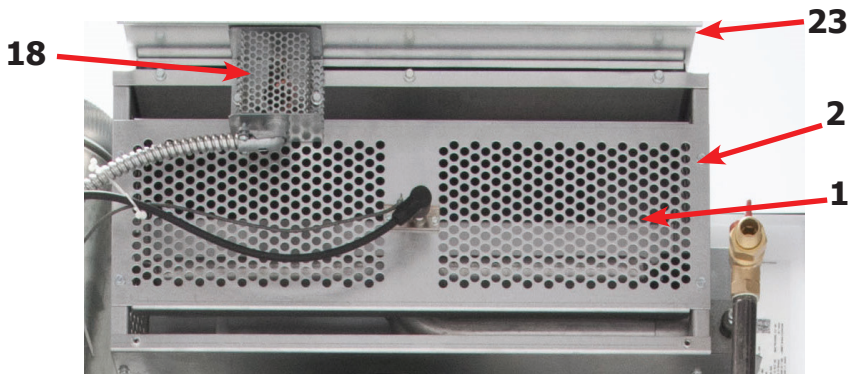

Bearing Housing Group

Key	Description	T-50X2-11 Reversing	QTY
	Bearing Housing Complete Assy (Includes bearings & Spacer)	9803-201-001	1
1	Housing, Bearing	9241-189-002	1
*	Bearing, Ball, Front	9036-159-001	1
*	Spacer, Bearing	9538-183-001	1
2	Bearing, Ball, Rear	9036-159-003	1
3	Screw-Wizlock, 1/2-13x3/4	9545-017-017	4
4	Nut, 1/2-13	8640-417-002	2
5	Screw, 1/2-13x1 1/2	9545-017-018	2
6	Nut, 1/2-13	8640-417-002	2

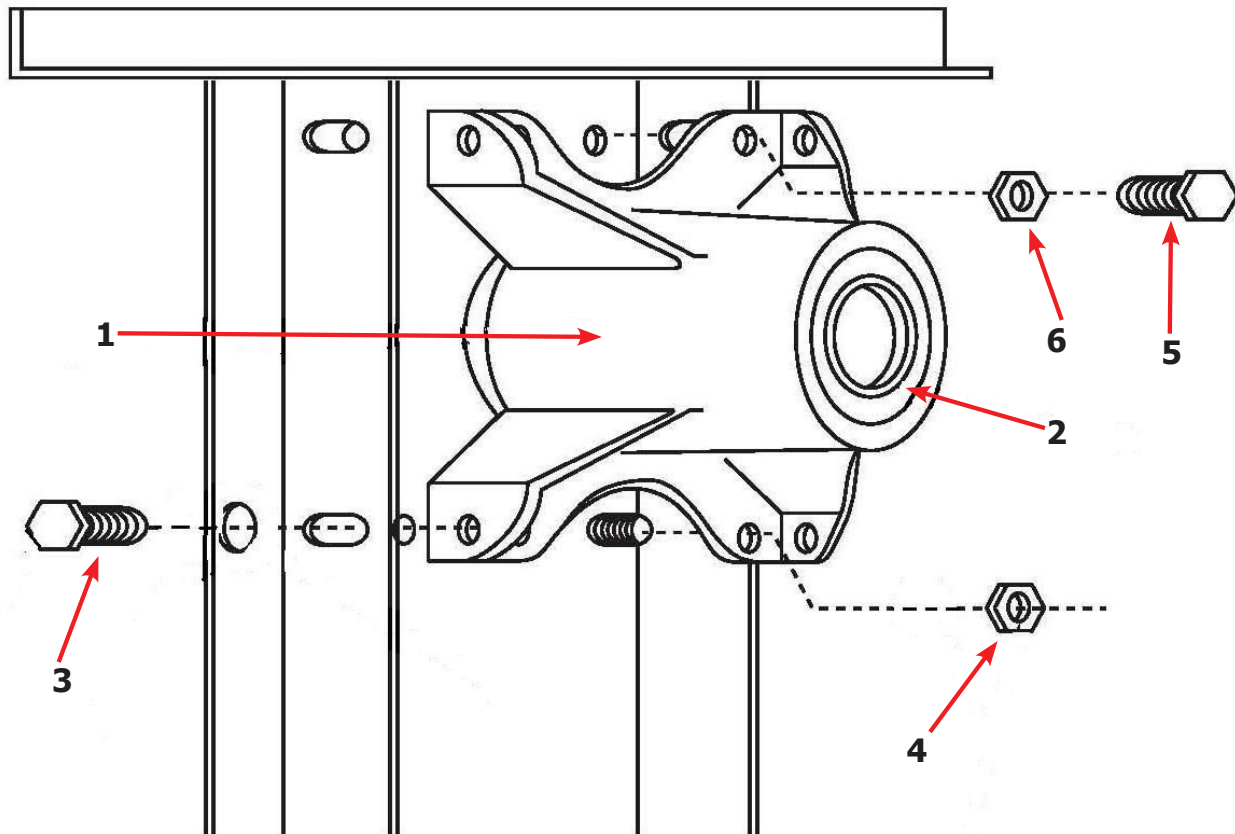
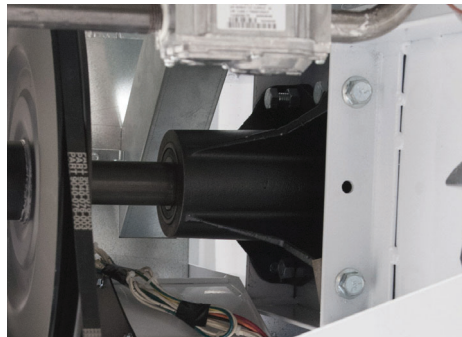

Tumbler Group

Key	Description	T-50X2-11 Reversing	QTY
*	Tumbler Assy Complete W/Spider (GALV)	9848-154-001	1
1	Tumbler Assy (Galvanized)	9848-148-001	1
*	Tumbler Assy Complete W/Spider (SS & Galv front)	9848-154-002	1
1	Tumbler Assy (Stainless Galvanized front)	9848-148-002	1
2	Rod, Tumbler	9497-226-002	3
3	Washer, Special	8641-590-002	3
4	Shim	9552-013-003	AR
5	Spider Assy	9568-017-001	1
6	Nut, Wiz Lock	8640-417-005	3
7	Spacer-Shaft	9538-188-001	1
8	Tolerance Ring	9487-234-005	1
9	Pulley, Driven	9908-047-002	1
10	Washer -Flat	8641-581-026	1
11	LockWasher - IntTooth, 1"	8641-582-016	1
12	Screw, 1/2-13x1 1/4	9545-017-009	1
*	Belt, Drive	9040-076-003	2

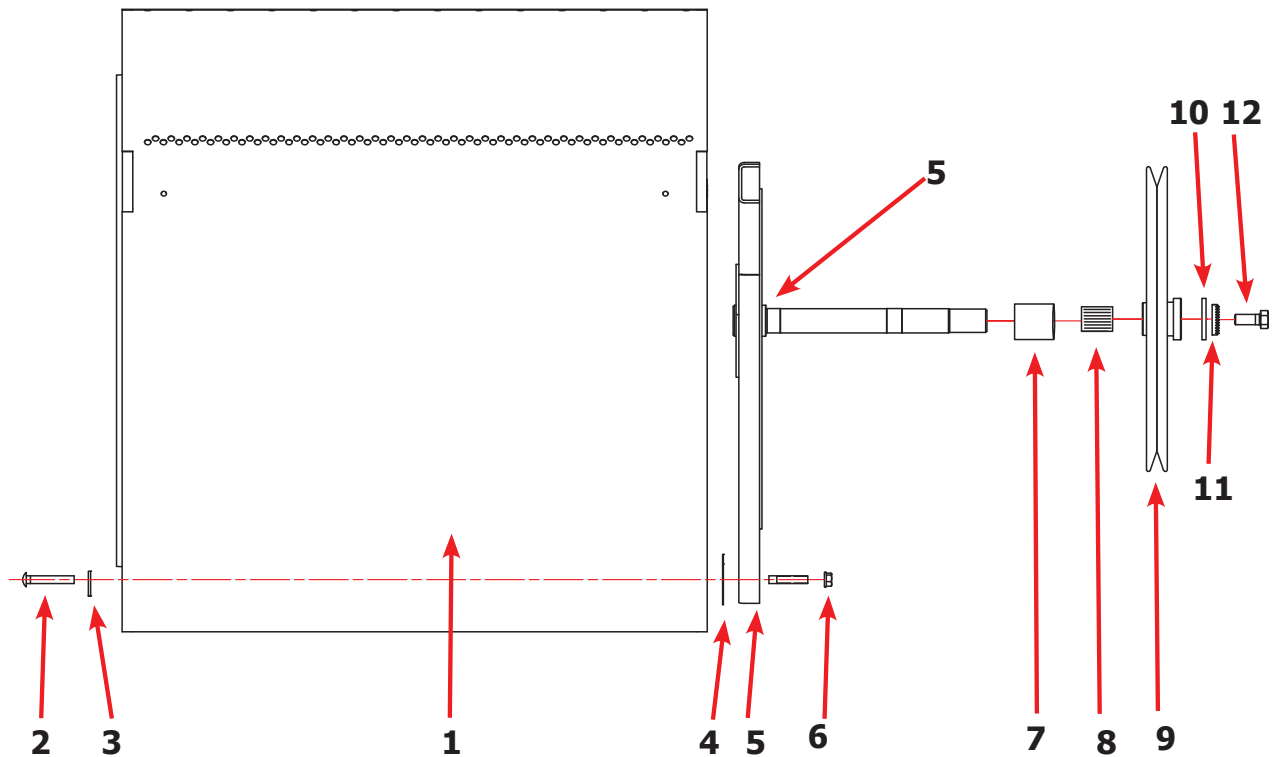

Dryer Rear View

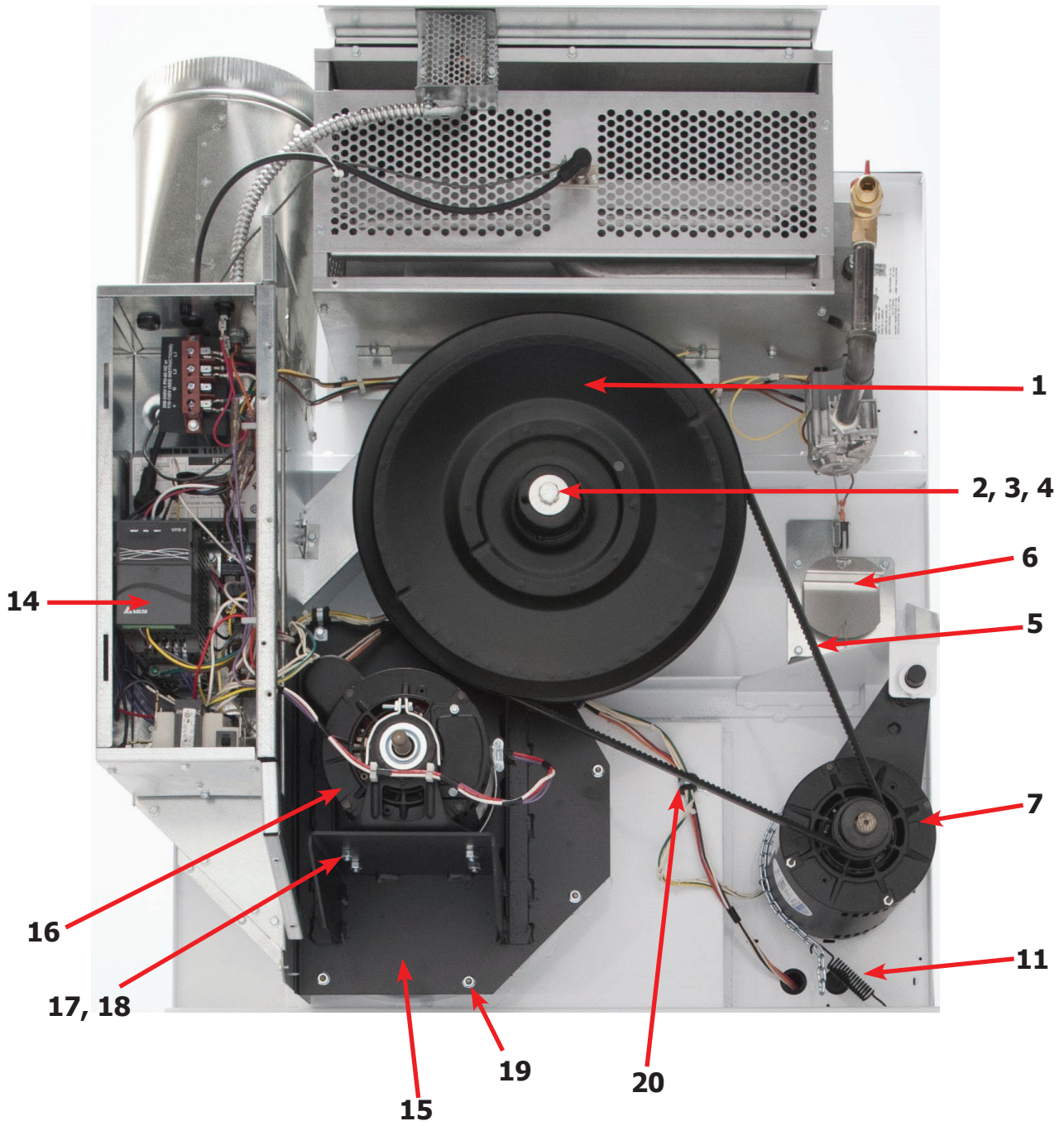

Key	Description	T-50X2-11 Reversing	QTY
*	Spacer, Tumbler pulley	9538-047-002	1
1	Pulley, Driven	9908-047-002	1
*	Tolerance Ring	9487-234-005	1
2	Washer-Flat, 1/2"	8641-581-026	1
3	Lock Washer, 1/2"	8641-582-016	1
4	Bolt, 1/2"-13 x 1" 1/4"	9545-017-009	1
5	Belt, Drive	9040-076-003	1
6	Air Flow Switch, Assembly	9801-098-001	1
7	Motor-Drive, 2Hp.	9376-319-001	1
8	Pulley-Motor, Drive	9453-169-012	1
*	Screw-Set, 5/16"-18 x 1/2"	9545-028-013	2
9	Rod-Motor Mounting	9497-222-008	1
*	Bushing, Motor Support	9053-074-002	2
10	Collar-Shaft, w/Set Screw	9076-052-002	2
11	Spring, Belt Tension	9534-319-002	1
12	Chain, Spring Tension, 15 1/2" (27 Links)	9099-012-008	1
13	Hook, "S" Hook	9248-022-002	1
14	Drive-VF, Inverter, 2Hp 230V	9375-032-010	1
15	Plate Assembly, Impeller-Blower Motor	9982-388-002	1
16	Motor, Blower	9376-311-005	1
17	Bolt-Motor Mounting, 5/16, 18 x 5/8"	9545-014-004	4
18	Nut, 5/16"-18	8640-400-003	4
*	Impeller, w/Set Screws	9278-043-001	1
19	Nut-1/4" x 20, Mounting Plate, Impeller Motor Assy.	8640-414-007-	7
20	Clamp, Conduit/Wiring	8654-126-004	3

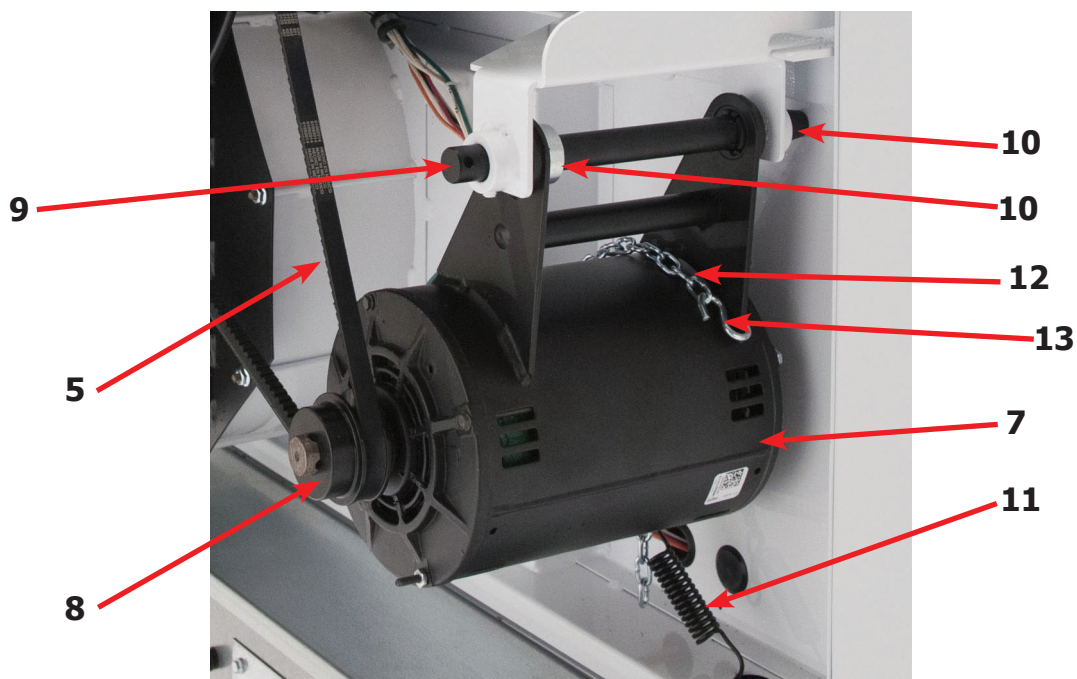

Control Assembly Group

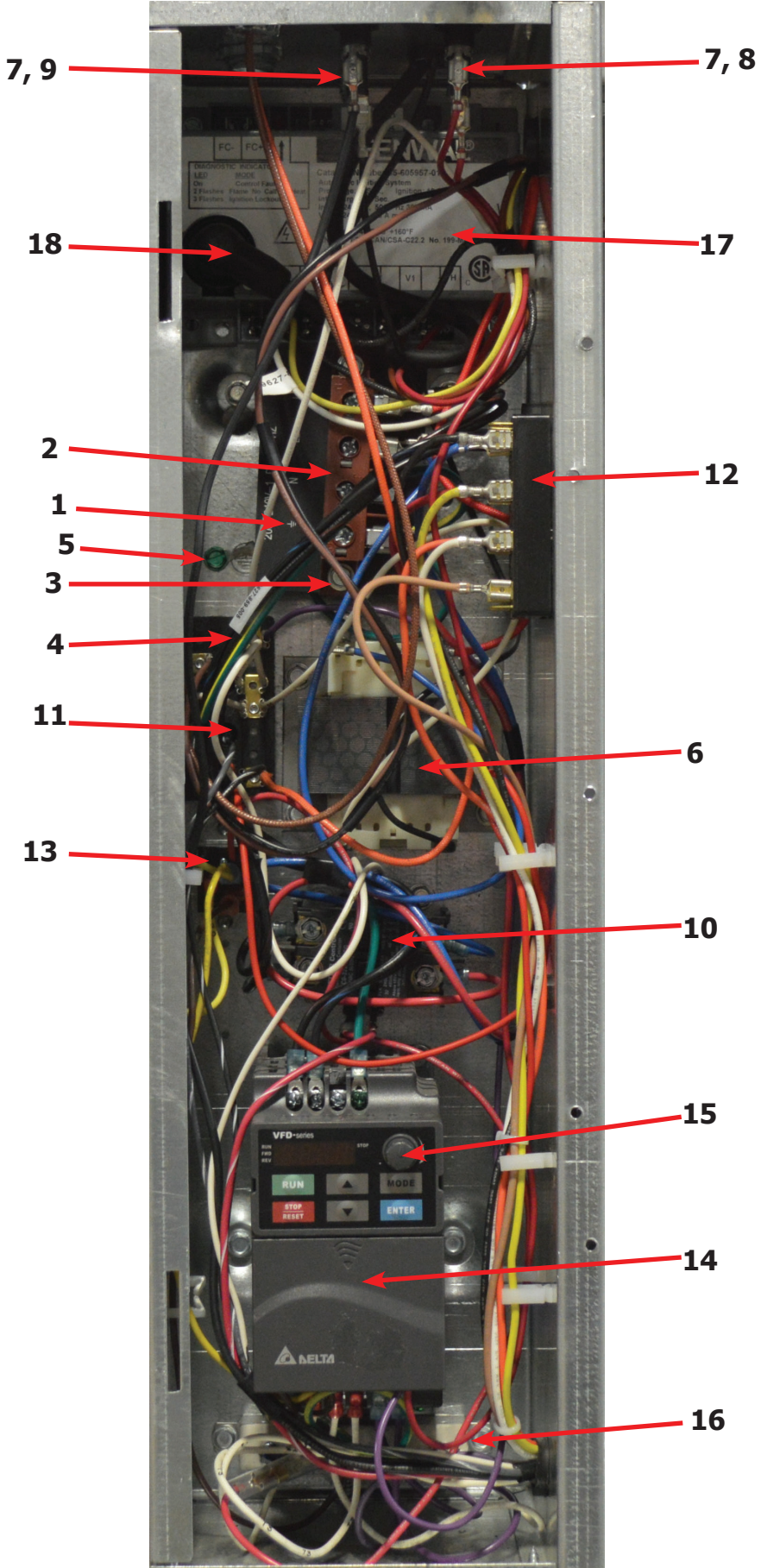

Control Assembly Group

Key	Description	T-50X2-11 Reversing	QTY
*	Control, Rear	9857-222-004	1
*	Bracket, Terminal Block Power	9029-202-001	1
1	Strip, Terminal Marker	9558-029-006	1
2	Terminal-Block, Power, 4 Pole	9897-035-001	1
3	Screw, 10AB x 3/8"	9545-008-024	1
*	Harness Assembly-Power Main Fork, Upper	9627-859-005	1
4	Wire Assembly-Ground, GRN/YEL, 7"	8220-137-002	1
*	Lock Washer, Ext tooth #10	8641-582-006	1
5	Screw, 10-32 x 1/2"	9545-008-027	1
6	Transformer, 208/240/60Hz. 24/120VA	8711-013-001	1
*	Screw, 10AB x 3/8"	9545-008-024	2
7	Fuse Holder Assembly	9200-001-002	2
8	Fuse, 1.5Amp/250V-Fast Acting	8636-018-001	1
9	Fuse, 2.5Amp/250V-Fast Acting	8636-018-004	1
10	Relay, Motor, 30Amp 24VAC	5192-299-002	1
*	Screw, Phillips, 8AB x 1/2"	9545-045-012	2
11	Terminal Block, Power	9897-026-001	1
*	Screw, Phillips, 8AB x 1/2"	9545-045-012	2
12	Terminal Block Power	9897-026-002	1
*	Screw, Phillips, 8AB x 1/2"	9545-045-012	2
13	Relay-Enable, 24Vac 50/60Hz	5192-285-004	1
*	Screw, Phillips, 8AB x 3/8"	9545-045-008	2
14	Drive-Inverter, 230V,	9375-032-010	1
*	Screw-Mounting, 10B x 1/2"	9545-008-026	4
15	Key-Pad, Display, Delta E-Drive	9150-044-001	1
16	Resister-Dynamic Breaking, 200Ohm	9483-004-002	1
*	Screw, 10AB x 3/8"	9545-008-024	2
*	Wire Assembly, Violet, 8"	8220-118-003	2
*	Screw, #6-32 x 5/16"	9545-044-006	2
*	Nut, Hexkeps, #6-32	8640-411-003	2
*	Harness-Assembly, Low Voltage, Upper	9627-867-007	1
17	Ignition Module	9857-182-001	1
*	Screw, 10AB x 3/4"	9545-008-018	2
18	Wire Assembly, High Voltage	9631-403-009	1
*	Door-Control Box	9108-138-001	1
*	Screw, 10AB x 3/8"	9545-008-024	3
*	Harness, Main (Internal Box)	9627-863-003	1
*	Harness Main Extention (External Box)	9627-913-002	1

Wiring Diagram

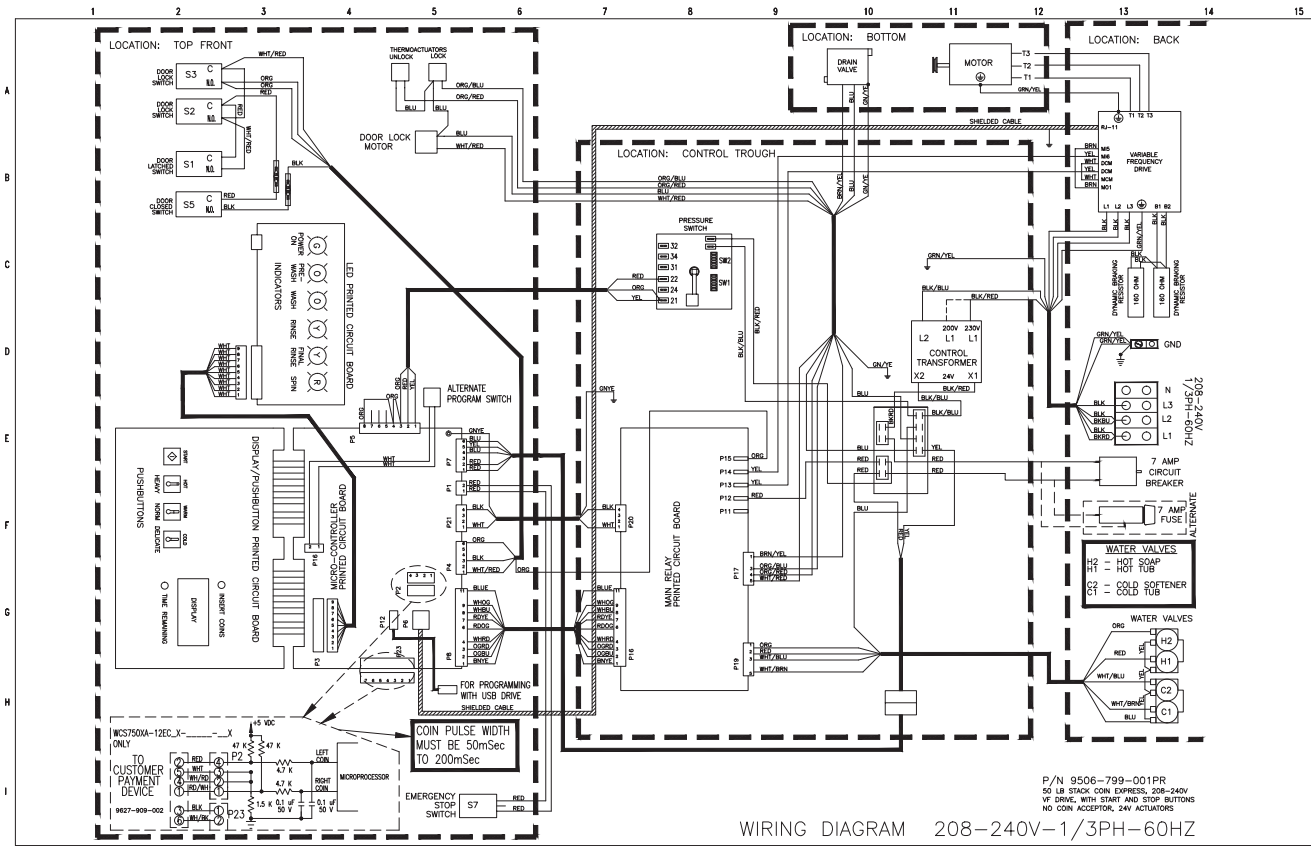

Wiring Schematic

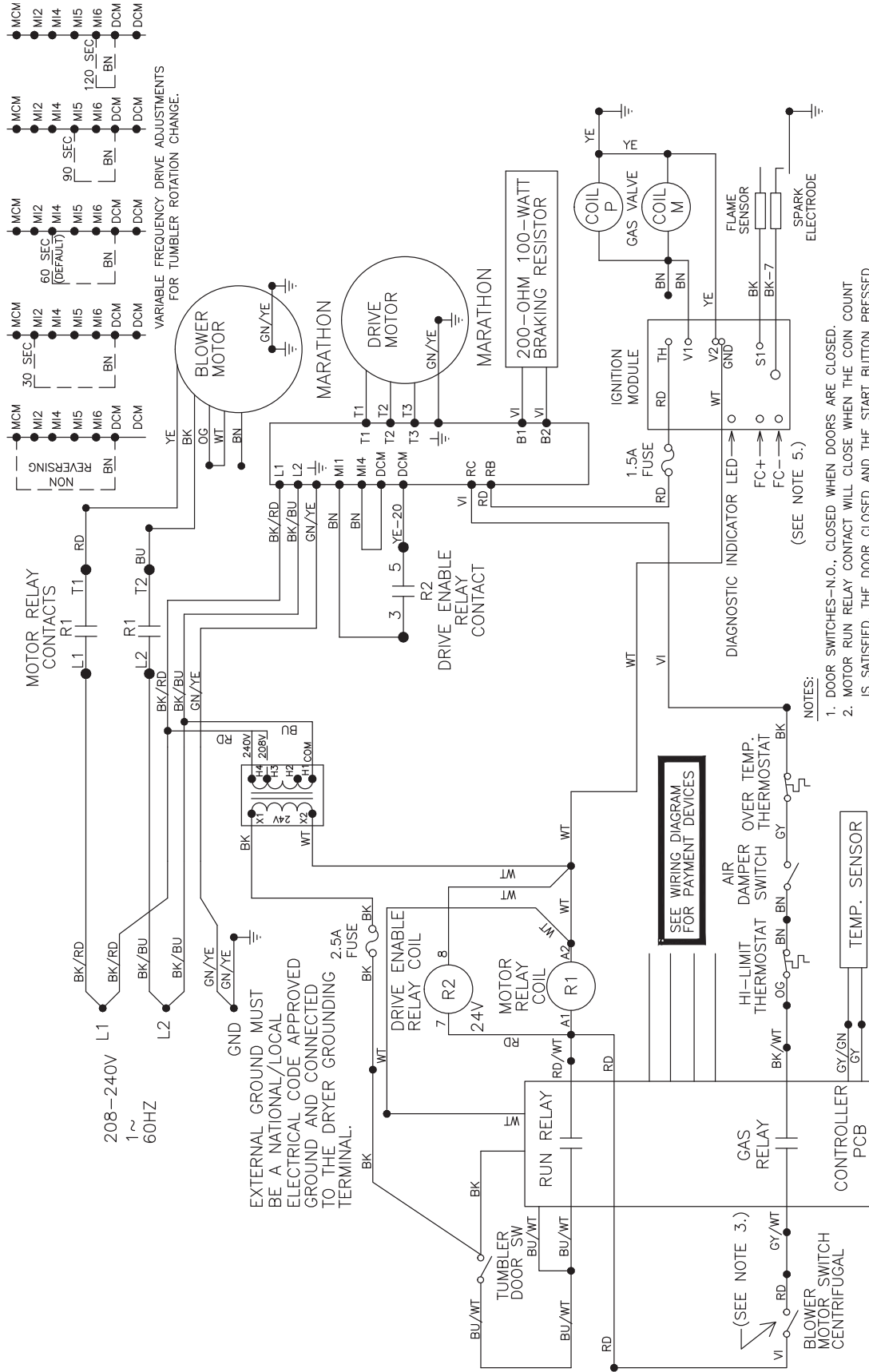

DCS050NC-11EC_R-_-_-_-X

SCHEMATIC

9506-797-001B

Coin Handling Group

Key	Description	Part Number	Qty
	Coin Acceptor, Optical, SWD, US Quarter	9021-094-001	1
*	Harness-Extention ,Control to Acceptor, Optical Dryer	9627-916-002	1
*	Retainer, Coin Acceptor	9486-145-001	1
*	Screw, Torx	9545-053-002	4
1	Switch Assembly, Optical Sensor, SWD	9801-099-003	1
*	Screw-Height Bar, 3mm	9545-039-002	2
	Below not included		
*	Harness, Acceptor Mechanical (Control to Acceptor)	9627-783-003	1
*	Coin Vault	9942-027-015	1
	Screw, 10AB X 3/8	9545-008-024	2

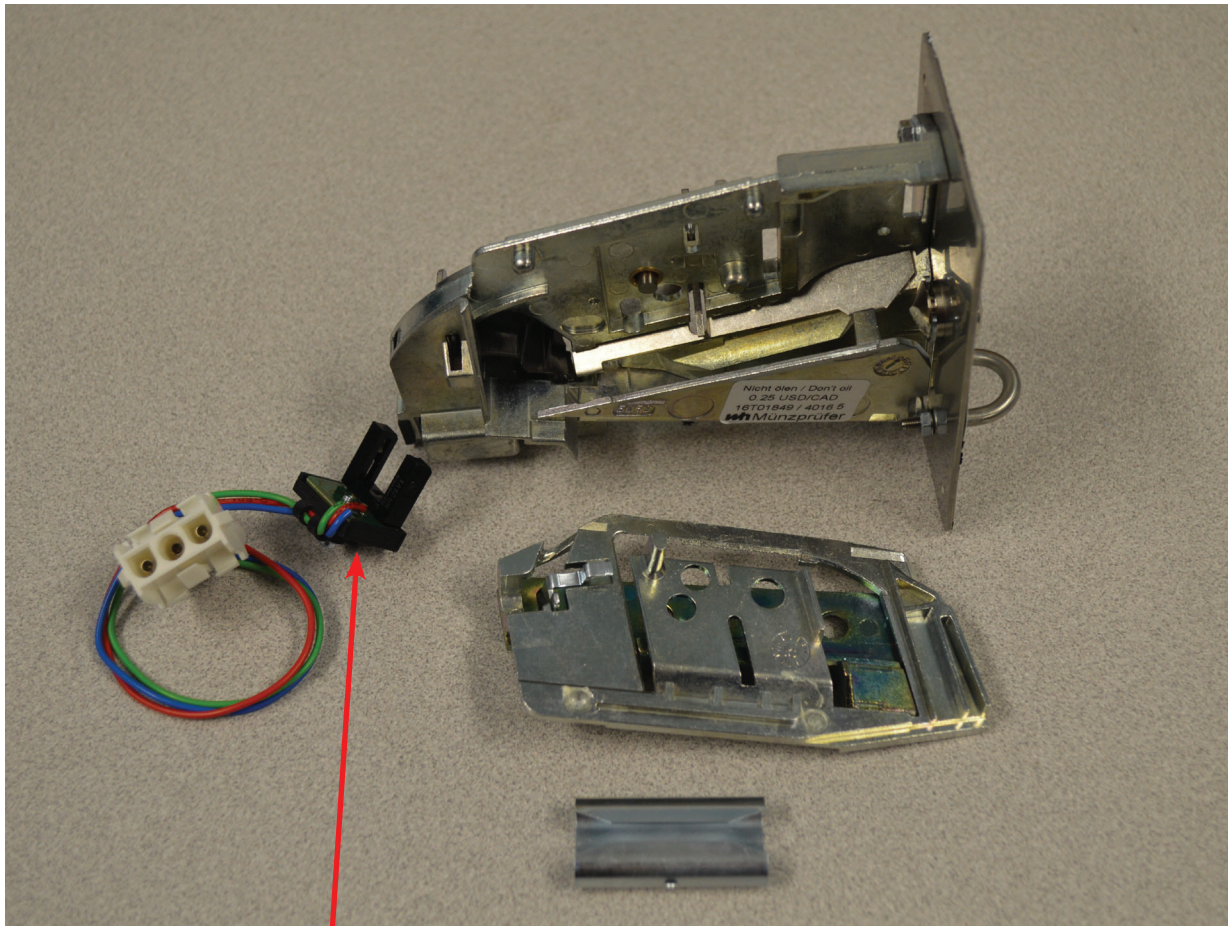

1

Coin Handling Group Electronic

Key	Description	Part Number	Qty
	Kit, Electronic Coin Acceptor	9732-303-004	1
	Acceptor-Electronic, US/CA	9021-054-001	1
	Harness, Control to Acceptor, Dryer (w/o lint screen switch)	9627-909-003	1
	Harness, Control to Acceptor, Dryer (with lint screen switch)	9627-909-005	1
	Harness, Control to Acceptor, Washerr	9627-909-002	1
	Lable-Wiring, Electronic Acceptor	8502-730-001	1
	Retainer Coin Acceptor, Electronic	9486-155-001	2
	Screw, 4B x 5/8 ss, Torx T-10	9545-053-002	4
	Below not included		
	Harness, Adaptor Electronic to Mechanical switch	9627-901-001	

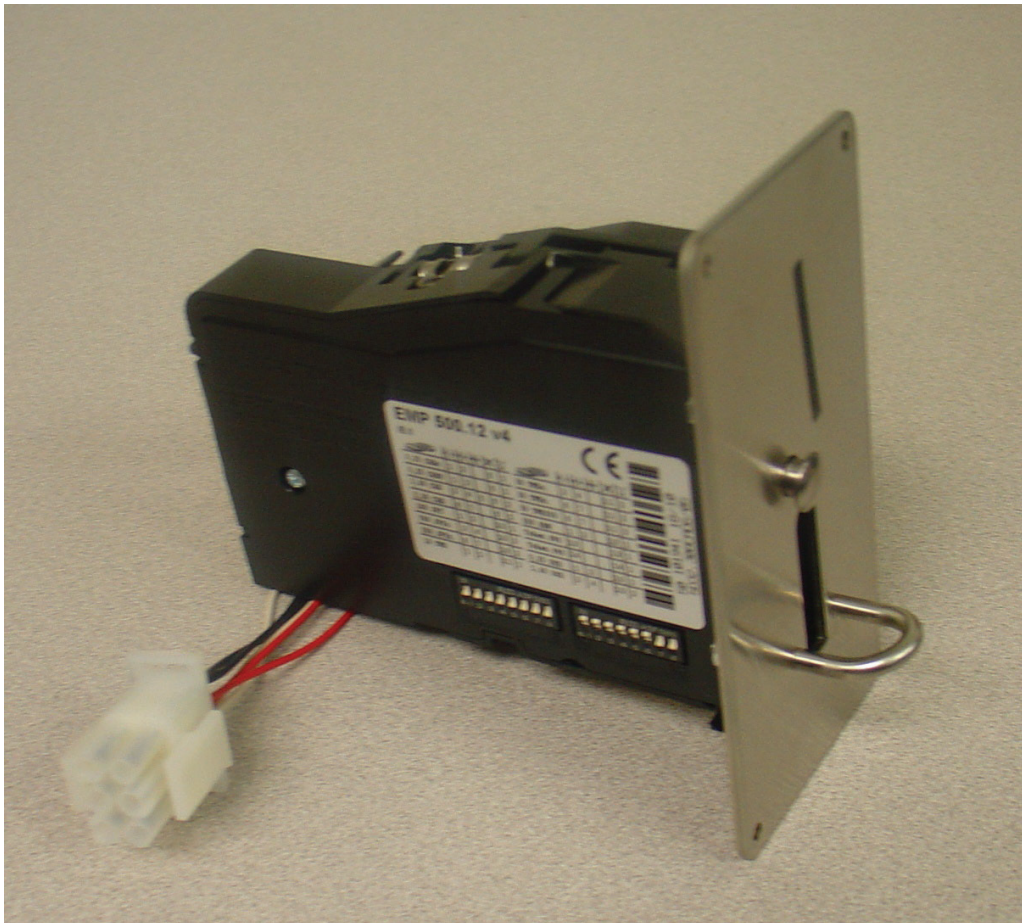

Section 6:

50 Hz Gas Dryer

Rear View Photos

	Description	T-50X2-39 Reversing	QTY
*	Spacer, Tumbler pulley	9538-047-002	1
1	Pulley, Driven	9908-047-002	1
*	Tolerance Ring	9487-234-005	1
2	Washer-Flat, 1/2"	8641-581-026	1
3	Lock Washer, 1/2"	8641-582-016	1
4	Bolt, 1/2"-13 x 1" 1/4"	9545-017-009	1
5	Belt, Drive	9040-076-003	1
6	Air Flow Switch, Assembly	9801-098-002	1
7	Motor-Drive, 2Hp.	9376-319-001	1
8	Pulley-Motor, Drive	9453-169-012	1
*	Screw-Set, 5/16"-18 x 1/2"	9545-028-013	2
9	Rod-Motor Mounting	9497-222-008	1
*	Bushing, Motor Support	9053-074-002	2
10	Collar-Shaft, w/Set Screw	9076-052-002	1
11	Spring, Belt Tension	9534-319-002	1
12	Chain, Spring Tension, 15 1/2" (27 Links)	9099-012-008	1
13	Hook, "S" Hook	9248-022-002	1
14	Drive-VF, Inverter, 2Hp 230V	9375-032-010	1
15	Plate Assembly, Impeller-Blower Motor	9982-388-002	1
16	Motor, Blower, 50HZ.	9376-311-004	1
17	Bolt-Motor Mounting, 5/16, 18 x 5/8"	9545-014-004	4
*	Nut, 5/16"-18	8640-400-003	4
*	Impeller, w/Set Screws	9278-043-001	1
18	Nut-1/4" x 20, Mounting Plate, Impeller Motor Assy.	8640-414-007	7

Rear View Photos

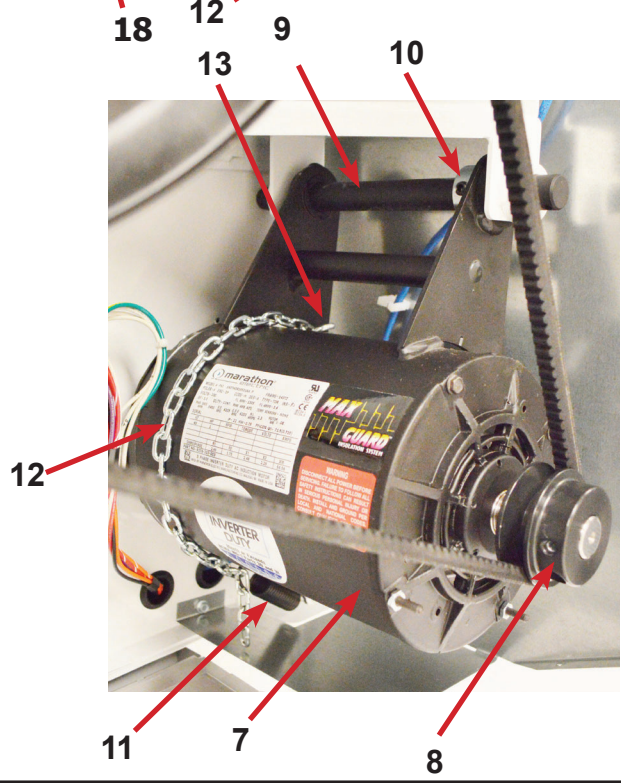
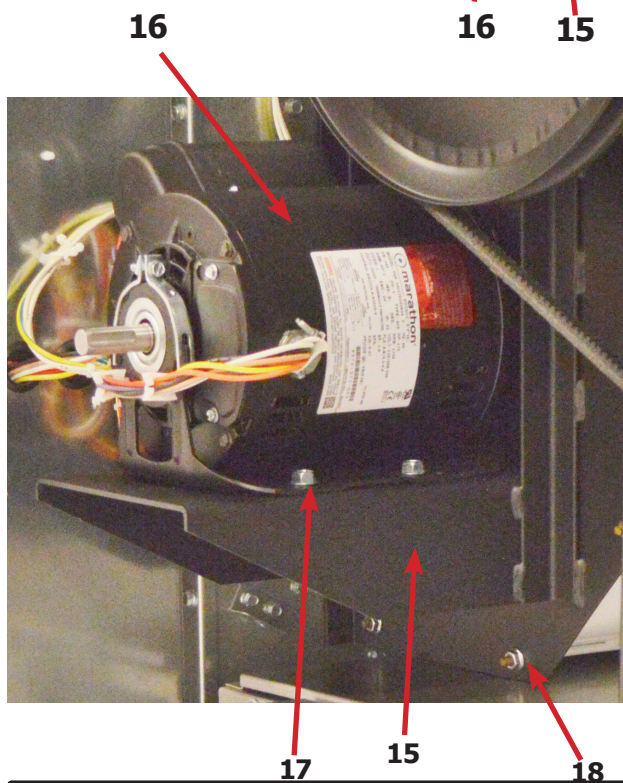
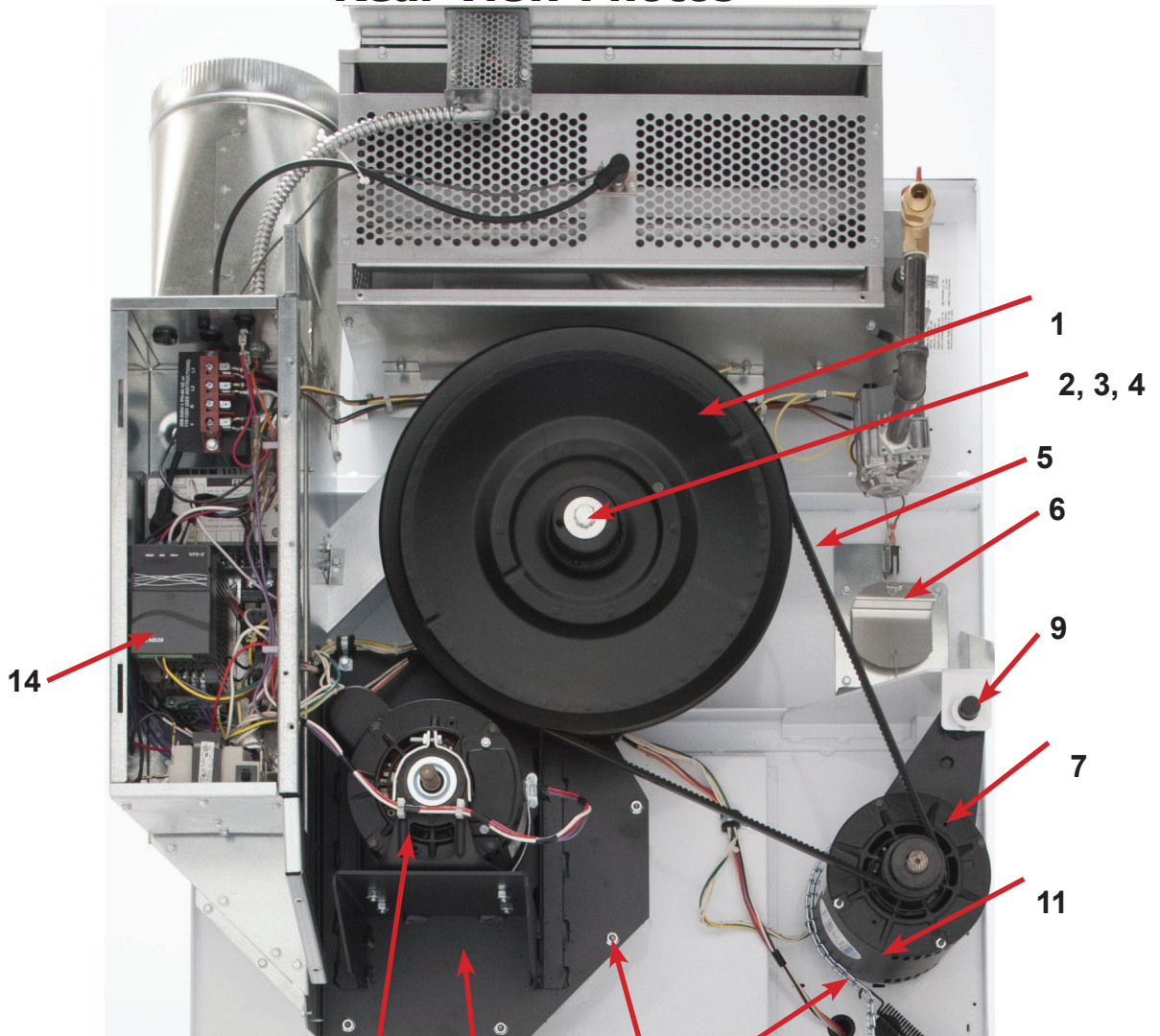

Electrical Component

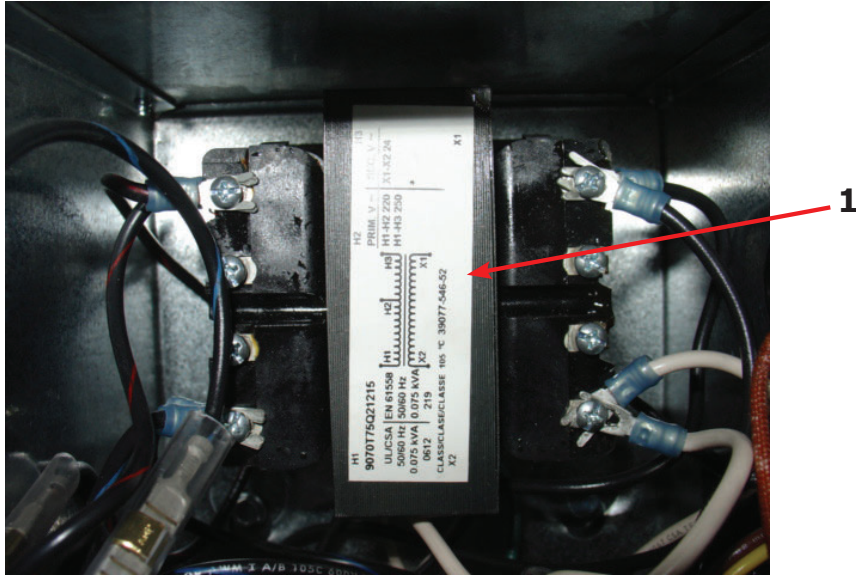

Key	Description	T-50X2-39Reversing	QTY
1	Transformer, 200/230-24 VAC, 50/60HZ	8711-004-004	1
*	Strip-Marker, Terminal	9558-029-004	1

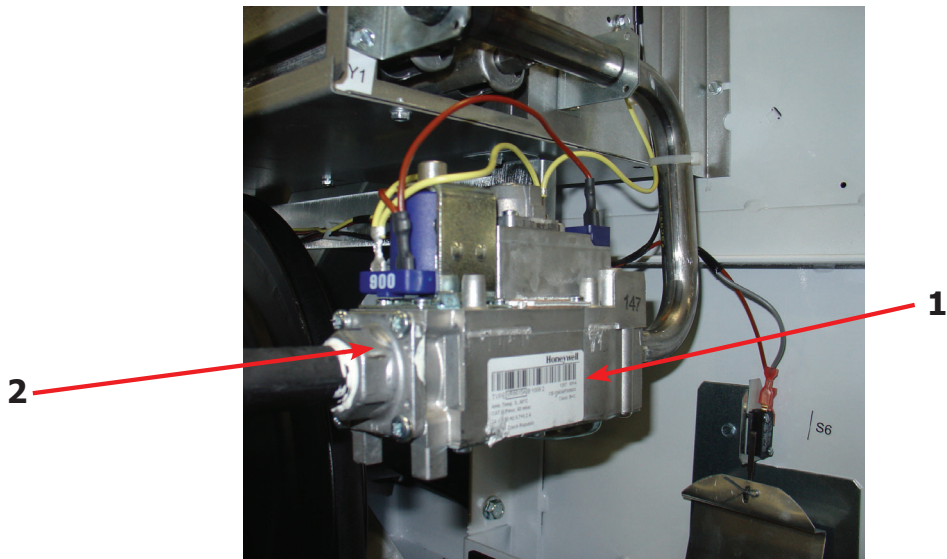

Key	Description	T-50X2-39 Reversing	QTY
1	Control Assembly, Gas Valve	9857-132-004	1
2	Kit-Honeywell VR86, Valve Flange assy	9732-162-001	2
*	Orifice, Main Burner, #30	9425-069-002	2
*	LP Kit	9732-102-035	1

Air Flow Switch Assembly

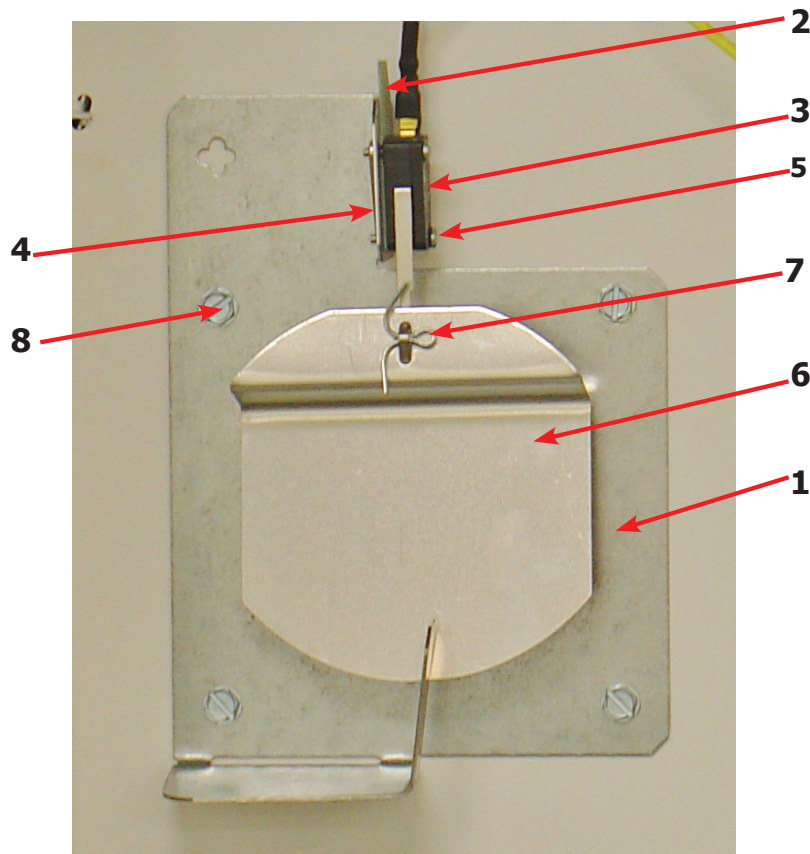

	Description	T-50X2-39 Reversing	
*	Air Flow switch Assy	9801-098-002	1
1	Bracket-Airflow switch	9029-200-002	1
2	Shield-Switch	9550-169-003	1
3	Switch-Micro	9539-461-009	1
4	Nut-Twin, 4-40	8640-401-001	1
5	Screw-.625, 4-40	9545-020-001	1
6	Actuator-Air Flow Switch	9008-007-001	1
7	Pin-Cotter, .09375x.75	9451-169-002	1
8	Screw, 10Bx3/8	9545-008-024	4
*	Harness Assembly, Overtemp/Airflow	9627-861-001	1

Coin Handling Group Electronic

Key	Description	Part Number	Qty
	Kit, Electronic Coin Acceptor	9732-303-004	1
	Acceptor-Electronic,	9021-054-001	1
	Harness, Control to Acceptor, Dryer	9627-909-003	1
	Harness, Control to Acceptor, Washerr	9627-909-002	1
	Label-Wiring, Electronic Acceptor	8502-730-001	1
	Retainer Coin Acceptor, Electronic	9486-155-001	2
	Screw, 4B x 5/8 ss, Torx T-10	9545-053-002	4
	Below not included		
	Harness, Adaptor Electronic to Mechanical switch	9627-901-001	1

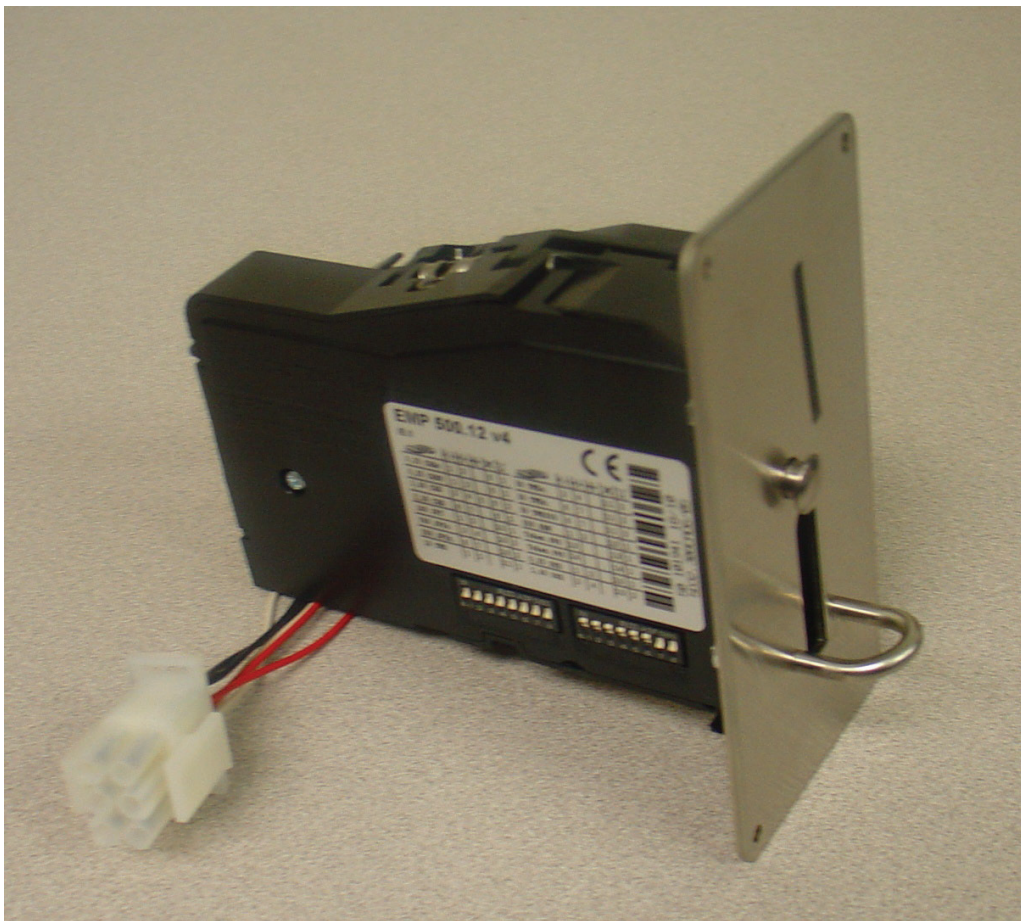

Wiring Diagram for Dryer 50hz 230V -21CR

9506-802-001A

WIRING DIAGRAM

DCS050NC-39XC-R

