



DEXTER
LAUNDRY







Dexter Commercial Vended Stack Washer Dryer T-450

Parts & Service Manual

Equipment Safety Warnings

Symbols and Terminology Used in this Equipment

⚠ DANGER	Indicates an imminently hazardous situation, which if not avoided, will result in death or serious injury.
⚠ WARNING	Indicates a potentially hazardous situation, which if not avoided could result in death or serious injury.
⚠ CAUTION	Indicates a potentially hazardous situation which, if not avoided, may result in minor or moderate injury. It may also be used to alert against unsafe practices. Minor burns, pinch points that result in bruises and minor chemical irritation.
NOTICE	Indicates information or a company policy that relates directly or indirectly to the safety of personnel or protection of property.
	This is the user caution symbol. It indicates a condition where damage to the equipment resulting in injury to the operator could occur if operational procedures are not followed. TO REDUCE THE RISK OF DAMAGE OR INJURY , refer to accompanying documents; follow all steps or procedures as instructed.
	This is the electrical hazard symbol. It indicates that there are DANGEROUS HIGH VOLTAGES PRESENT inside the enclosure of this product. TO REDUCE THE RISK OF FIRE OR ELECTRIC SHOCK , do not attempt to open the enclosure or gain access to areas where you are not instructed to do so. REFER SERVICING TO QUALIFIED SERVICE PERSONEL ONLY
	Caution! There are sharp edges on various sheet metal parts internal to the enclosure. Use safety consciousness when placing or moving your hands while working in the interior of this equipment.
	Caution! To reduce the risk of damage to the Water Inlet Valve, do not supply inlet water with a temperature that exceeds 70° C. Caution! To reduce the risk of fire or explosion, do not operate this equipment in any hazardous classified (ATEX) environment.

Equipment Safety Warnings

Symbols and Terminology Used in this Equipment



Warning! Do not operate equipment if door glass is damaged in any way.



Warning! Keep clear of rotating parts.



Prohibited! Do not enter this equipment or space.



Prohibited! Do not step or stand on this equipment.



Prohibited! Do not operate without all guards and covers in place.









Prohibited! Do not operate without all guards and covers in place.



Prohibited! Do not wash clothing impregnated with flammable liquids (petrochemical).



Prohibited! Do not allow children to play in or around equipment.

	<p>Indicates an imminently hazardous situation, which if not avoided, <u>will result</u> in death or serious injury.</p>
	<p>Indicates a potentially hazardous situation, which if not avoided <u>could result</u> in death or serious injury.</p>
	<p>Indicates a potentially hazardous situation which, if not avoided, <u>may result</u> in minor or moderate injury. It may also be used to alert against unsafe practices. Minor burns, pinch points that result in bruises and minor chemical irritation.</p>
	<p>Indicates information or a company policy that relates directly or indirectly to the safety of personnel or protection of property.</p>
	<p>This is the user caution symbol. It indicates a condition where damage to the equipment resulting in injury to the operator could occur if operational procedures are not followed. TO REDUCE THE RISK OF DAMAGE OR INJURY, refer to accompanying documents; follow all steps or procedures as instructed.</p>
	<p>This is the electrical hazard symbol. It indicates that there are DANGEROUS HIGH VOLTAGES PRESENT inside the enclosure of this product. TO REDUCE THE RISK OF FIRE OR ELECTRIC SHOCK, do not attempt to open the enclosure or gain access to areas where you are not instructed to do so. REFER SERVICING TO QUALIFIED SERVICE PERSONEL ONLY</p>
	<p>Caution! To reduce the risk of fire or explosion, do not operate this equipment in any hazardous classified (ATEX) environment.</p>



WARNING



•All washers must be installed in accordance to all applicable electrical, plumbing and all other local codes.

•These installation and operation instructions are for use by qualified personnel only. To avoid injury and electrical shock, do not perform any servicing other than that contained in the installation and operation instructions, unless qualified.



Do not install washers in an explosive atmosphere.



•Care must be stressed with all foundation work to ensure a stable unit installation, eliminating possibilities of excessive vibration.

•Foundation must be level within 13 mm to ensure proper washer operation.



Do not operate washer if door glass is damaged in any way.



Do not wash clothing impregnated with flammable liquids (petrochemical).



WARNING







	<p>Children should be supervised to ensure they do not operate or play in or around equipment.</p>
	<p>Keep all panels in place to protect against electrical shock and injury and add rigidity to washer.</p>

This appliance is not intended for use by persons (including children) with reduced physical, sensory or mental capabilities, or lack of experience and knowledge, unless they have been given supervision or instruction concerning use of the appliance by a person responsible for their safety.

A washer should not be allowed to operate if any of the following occur:

- **Excessive high water level.**
- **Machine is not connected to a properly earthed circuit.**
- **Door does not remain securely locked during the entire cycle.**
- **Vibration or shaking from an inadequate mounting or foundation**

	<p>Warning! Do not operate equipment if door glass is damaged in any way.</p>
	<p>Warning! Keep clear of rotating parts.</p>
	<p>Prohibited! Do not enter this equipment or space.</p>
	<p>Prohibited! Do not step or stand on this equipment.</p>
	<p>Prohibited! Do not operate without all guards and covers in place.</p>
	<p>Prohibited! Do not operate without all guards and covers in place.</p>
	<p>Prohibited! Do not wash clothing impregnated with flammable liquids (petrochemical).</p>
	<p>Prohibited! Do not allow children to play in or around equipment.</p>

	<p>Prohibited! Do not attempt to open, touch, or proceed before referring to the manual or unless qualified.</p>
	<p>Mandatory! Read all supporting documentation before operating or maintaining equipment.</p>
	<p>Mandatory! Disconnect power before servicing equipment.</p>
	<p>Mandatory! Lock out and tag out before servicing this equipment.</p>
	<p>Mandatory! Disconnect water supply before servicing equipment.</p>
	<p>Mandatory! Children should be supervised to ensure they do not operate equipment.</p>

Dexter Safety Guidelines



WARNING

These washers are equipped with devices and features relating to their safe operation. To avoid injury or electrical shock, do not perform and service, unless qualified to do so.

FOR SAFETY

1. Always shut off power and water supply and also discharge capacitors before servicing.
2. Do not overload the washer.
3. Do not attempt to open door if cylinder is in motion or contains water.
4. Do not mechanically force or override door lock in any way.
5. Do not bypass any safety devices of this washer.
6. Do not use volatile or flammable substances in or near this washer.
7. Keep all panels in place. They protect against shock and injury and add rigidity to the washer.

A machine should not be allowed to operate if any of the following occur:

- Excessively high water level.
- Machine is not connected to a properly grounded circuit.
- Loading door does not remain securely locked during the entire cycle.
- Vibration or shaking from an inadequate mounting or foundation.

To activate your warranty, be sure to return your red warranty form to the factory. Please have serial number and model ready when calling for assistance.

Table of Contents

Section 1:

Specifications, Mounting Dimensions

Specifications.....	12 - 14
Dimensions.....	15 - 16

Section 2:

Installation & Operating Instructions

Washer Installation	18
Electrical Connections & Fusing Requirements .	19
Dryer Installation.....	20
Dryer Electric, Gas and Venting.....	21 - 22
Washer Operating Instructions.....	23 - 24
Emergency Stop Button	23
Dryer Operating Instructions.....	24

Section 3:

Washer and Dryer Programming Instructions

Rapid Advance Mode.....	28
Washer Price Programming.....	30 - 31
Wash Cycle Programming.....	32 - 35
Dryer Programming.....	44 - 57

Section 4:

Dryer Service, Troubleshooting and Schematics

Dryer Service Procedures.....	60 - 65
Dryer Control Fault Codes.....	69 - 70
Dryer Troubleshooting Tips.....	71 - 72
Dryer Schematics 60hz.....	76 - 77

Section 5:

Dryer Parts Data.....	80 - 100
-----------------------	----------

Section 6:

50hz Gas Dryers

50hz Dryer Parts.....	102 - 105
50hz Dryer Schematics.....	107 - 108

Section 8:

Washer Service and Troubleshooting

Electronic Coin Drop Acceptor.....	110
Electronic Coin Drop Maintenance.....	111 - 114
Mechanical Coin Drop Acceptor.....	116
Front Panel Removal	116

Back Panel Removal	116
Drain Valve Access	116
Drain Valve Cleaning	116
Detergent Dispenser	118
Vacuum Breaker/Air Gap	118
Water Valves	118
Door Lock Assembly Operation	118
Adjustment for Door Lock Assembly.....	118-119
Adjusting the Loading Door	120
Loading Door Removal	120
Loading Door Hinge Removal.....	120
Loading Door Disassembly	120
Loading Door Reassembly	121
Control Panel Name Plate Decal.....	121
Name Plate Removal	121
Re-Installation of Name Plate.....	121
Removal of the Washer Tub Assembly From the Washer Frame	121
Bearing Housing Water Seals	123
Bolt Torque Chart.....	124
Control Mounting Trough.....	125
Main Data Communication Cable.....	125
Circuit Breaker/Fuse	125
Main Control Printed Circuit Board.....	125
Controls Transformer.....	125
Main Relay Printed Circuit Board	125
LED Printed Circuit Board Temperature & Start Display Push Button.....	126
Add Bleach LED	126
Emergency Stop Button & Switch Assembly...	126
Power Connection Terminal Block	126
Pressure Switch	127 - 128
Delta Variable Frequency Drive	129
Delta VFD Motor Leads.....	129
Delta VFD Dynamic Braking Resistors	129
Delta VFD Cooling Fan	129
Washer Trouble Shooting and F - Codes...130 - 141	

Section 8:

Washer Electrical & Wiring Schematics	
Start Circuit	144
Fill Circuit	144- 145
Wash Circuit	145
Drain, Rinse 1, 2 & Final Rinse Circuit.....	145
Extract Circuit.....	145
Thermoactuator and Shake Out Circuit.....	146
End of Cycle Circuit	146
Motor Winding Resistances.....	146
Washer Electrical & Wiring Schematics 60hz	148 - 149

Section 9:

Washer Parts Data	
C-Series Accessories.....	152
Rear View Access Parts	154
Cabinet and Front Panel Group	157
Cylinder, Seals & Bearings Parts	158
Door Lock Parts	160 - 161
Loading Door Parts	163
Drain Valve Group Parts	164
Water Inlet Parts	165
Chasis and Drain Parts.....	166
Electrical Components	168 - 170
Labels.....	171
Coin Handling Group Parts	171 - 173

Section 10:

50hz Washer	178
-------------------	-----

Section 12:

Maintenance Dryer.....	182
Maintenance Washer.....	183

Section 1:

Washer and Dryer Specifications and Mounting

Stacked Washer Dryer Models

Stacked Model Designation	Washer \ Dryer Model #	Electrical Spec: Circuit Breaker / Running Amps / Wire Size/ Option
SC0450ND-17EC3X-SWBCG-USA 9999-720-001	Dcs030nd-15ec2x-swbcg-usa	208-240/60/1, Single 2 Wire + Ground, States Quarter Acceptor
	Wcs450xb-12ec3x-swbcg-usa	208-240/60/1or3, Single 2 Wire + Ground, 3 Phase 3 Wire + Ground, United States Quarter Acceptor
SC450ND-17EC3X-SWBCS-USA 9999-720-002	Dcs030nd-15ec2x-swbcg-usa	208-240/60/1, Single 2 Wire + Ground, States Quarter Acceptor
	Wcs450xb-12ec3x-swbcg-usa	208-240/60/1or3, Single 2 Wire + Ground, 3 Phase 3 Wire + Ground, United States Acceptor
SC0450ND-17EC3X-SWBCS-USX 9999-720-004	Dcs030nd-15ec2x-swbcg-usx	208-240/60/1, Single 2 Wire + Ground, No acceptor
	Wcs450xb-12ec3x-swbcg-usx	208-240/60/1or3, Single 2 Wire + Ground, 3 Phase 3 Wire + Ground, No acceptor
SC0450ND-17EC3X-SWKCS-USA 9999-720-006	Dcs030nd-15ec2x-swbcg-usa	208-240/60/1, Single 2 Wire + Ground, United States Quarter Acceptor
	Wcs450xb-12ec3x-swbcg-usa	208-240/60/1or3, Single 2 Wire + Ground, 3 Phase 3 Wire + Ground, United States Quarter Acceptor
SC0450ND-39AC3X-SWBMS-VRX 9999-720-014	Dcs030nd-39ac2x-swbcg-usa	230/50/1, Single 2 Wire + Ground,, No acceptor
	Wcs450xb-39xc3x-swbcg-usa	230/50/1, Single 2 Wire + Ground,, No acceptor
SC0450ND-17EC3X-SWBMS-USX 9999-720-057	Dcs030nd-15ec2x-swbcg-usx	208-240/60/1, Single 2 Wire + Ground, No acceptor
	Wcs450xb-12ec3x-swbcg-usx	208-240/60/1or3, Single 2 Wire + Ground, 3 Phase 3 Wire + Ground, No acceptor

Washer Specifications:

Dry Weight Capacity	30 lbs	(13.6 kg)
Cylinder Diameter	25"	(63.5 cm)
Cylinder Depth	14.13"	(35.9 cm)
Cylinder Volume	4 cu ft	(113.4 l)
Floor to Door Bottom	16"	(40.61 cm)
Door Opening	15.25"	(38.71 cm)

Speeds G-Force (RPM)

High Extract Speed	200 G	750 RPM
Intermed. Extract Speed	60 G	411 RPM
Washing Speed	.96	50 RPM
Motor Size	2 HP	1.5 kw

Electrical

Electrical Phase	Single or Three	
Electrical Voltage (60 Hz)	208-240	
Electrical Running (Amps)	6.2	
Circuit Protection (Amps)	15 amp	
Electrical Wire Size	12 gauge	
Electrical Service (Single)	2 wire + ground	
Electrical Service (Three)	3 wire + ground	

Water

Water Inlet Size	3/4"	(19mm)
Flow Rate (per min)	9 gal	(34.1 L)
Pressure (min/max)	30-120 psi	(207-827 Kpa)
Drain Diameter (O.D.)	3"	(7.61 cm)
Floor to Center of Drain	4.5"	(11.23 cm)

Installation Recommendations

Clearance Between Machines	1/2 (min)	(1.31 cm)
Clearance Behind Machines	24" (min)	(61.0 cm)
Concrete Thickness	6" (min)	(15.24 cm)
Net Weight	1039 lbs	(471.3 kg)
Shipping Weight	1090 lbs	(494.4 kg)

Approvals** UL/CSA

Cabinet Dimensions

Height - in (cm)	78.75"	(200.0cm)
Width - in (cm)	31.5"	(80.0cm)
Depth - in (cm)	48"	(115.2 cm)

SPECIFICATIONS

30 lb. Commercial Dryer: T-30 SWD DCS030N_-15EC_X (60Hz), DCS030N_-39AC_X (50Hz)

Cabinet Height (As a stand-alone dryer)	38 7/8"	987 mm.
(Assumes minimum leveling leg adjustment)		
Cabinet Height (Combo washer/dryer)	78 3/4"	2000 mm.
Cabinet Width	31 1/2"	800 mm.
Overall Depth	49 7/16"	1256 mm.
Floor to Door Center (Stand-alone)	7"	178 mm.
Floor to Door Center (Combo)	47"	1194 mm.
Door Opening	22 5/8"	575 mm.
Dry Wt. Capacity	30 lbs.	13.6 kg.
Cylinder Diameter	30"	762 mm.
Cylinder Depth	27 1/2"	699 mm.
Cylinder Volume	11.25 cu. ft.	319 liters
Lint Screen Area	453 sq. in.	2923 sq. cm.
Gas Input (60 hz)	80,000 Btu/hr	23.4 kW or 84 MJ/Hr
Gas Input (50 hz)	74,000 Btu/hr	21.7 kW or 78 MJ/Hr
Gas Supply Connection	1/2"	12.7 mm.
Natural Gas Supply (Water Column)	5-8"	127 mm. - 203 mm.
Natural Burner Manifold Pressure		
(60 hz Water Column)	3.5"	.87 kPa
(50 hz Water Column)	3.4"	.84 kPa
L.P. Supply (Water Column)	11 1/2 -14"	292 mm. - 356 mm.
L.P. Burner Manifold Pressure		
(60 hz Water Column)	11"	2.7 kPa
(50 hz Water Column)	10"	2.5 kPa
Exhaust Size	6"	152 mm.
Make-up Air	1.0 sq. ft.	929 sq. cm.
Example: 1.0 sq. ft = 1 ft. long X 1 ft. wide		
Motor Size	1/2 H.P.	.373 kW
Airflow (60 hz)	500 CFM	14.2 m ³ /min
Airflow (50 hz)	450 CFM	12.7 m ³ /min

Dryer Electrical Specifications – 208-240/60/1

Voltage/Hz/Phase	208-240V/60Hz/1Phase
Running Amps	2.5
Circuit Protection Amps	15
Wire Size	12 gauge
Electrical Service	2 wire + ground

Dryer Electrical Specifications - 120/60/1

Voltage/Hz/Phase	120V/60Hz/1Phase
Running Amps	4.0
Circuit Protection Amps	15
Wire Size	12 gauge
Electrical Service	2 wire + ground

Dryer Electrical Specifications - 230/50/1

Voltage/Hz/Phase	230V/50Hz/1Phase
Running Amps	5.0
Circuit Protection Amps	15
Wire Size	12 gauge
Electrical Service	2 wire + ground

Stand-alone Dryer

Shipping Weight	420 lbs.	191 kg.
Net Weight	380 lbs.	172 kg.
Clearance Behind Machines (min.)	18"	457 mm.

Combo Stack Washer/Dryer

Shipping Weight	1101 lbs.	499 kg.
Net Weight	1051 lbs.	477 kg.
Clearance Behind Machines (min.)	24"	611 mm.

Machine Dimensions:

T-450SWD COMMERCIAL STACK WASHER/DRYER MOUNTING DIMENSIONS

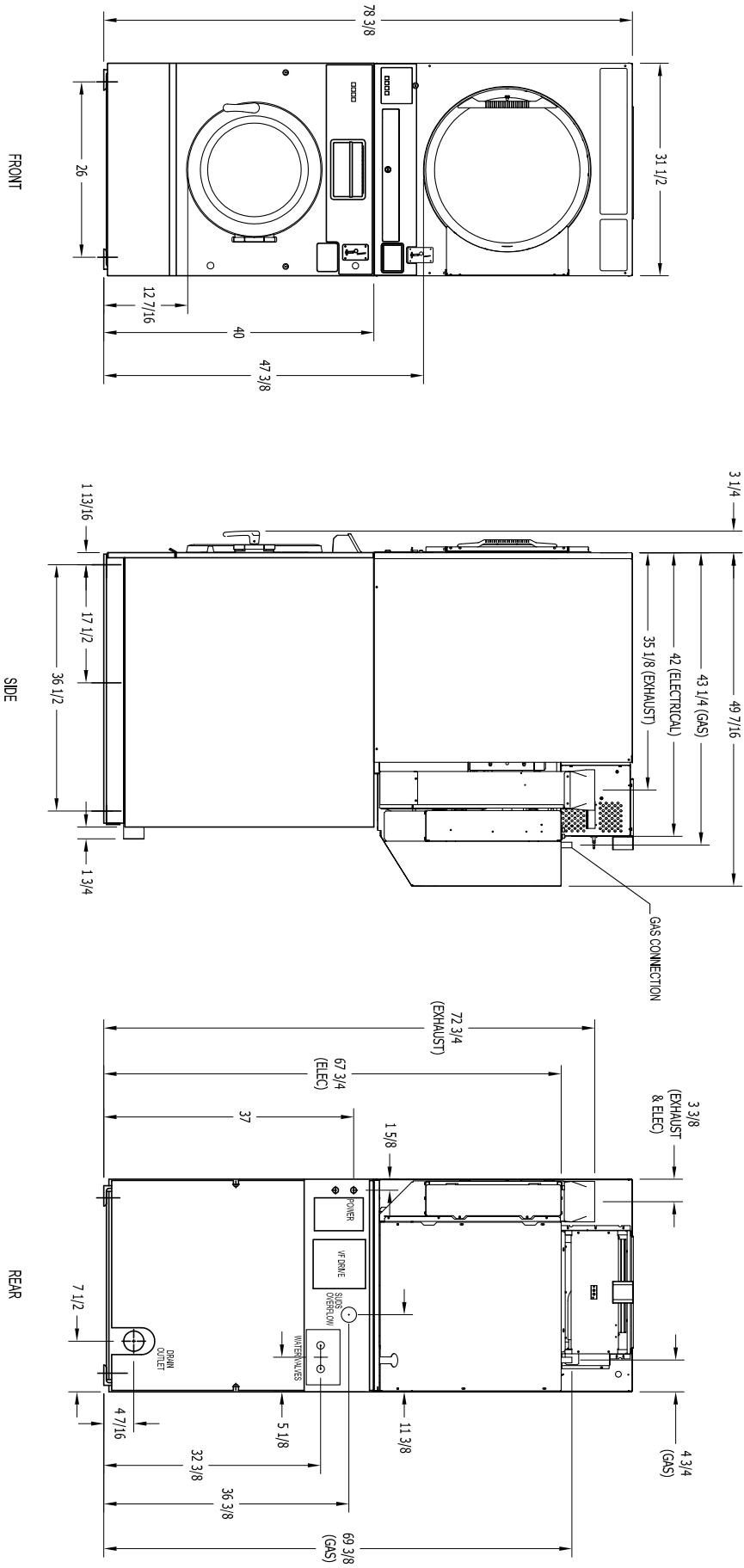

SWD Mounting Pad Dimensions

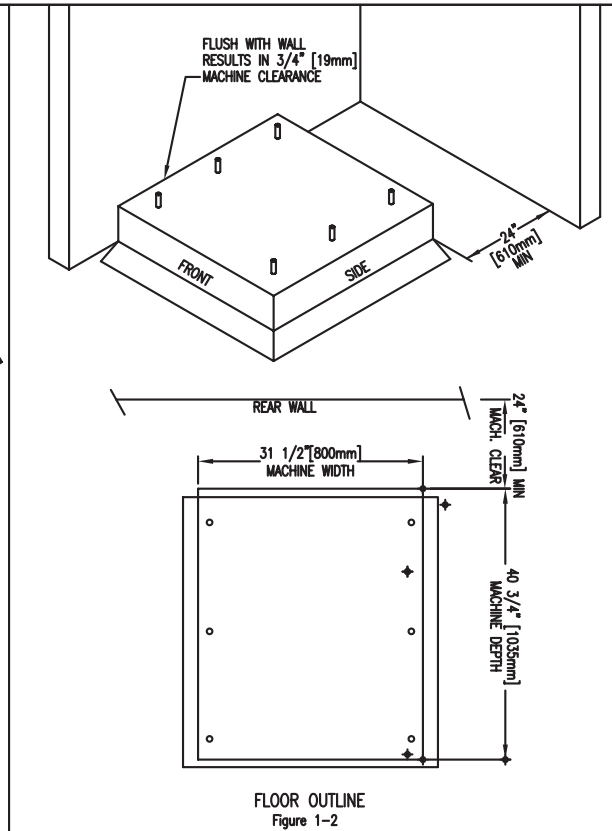
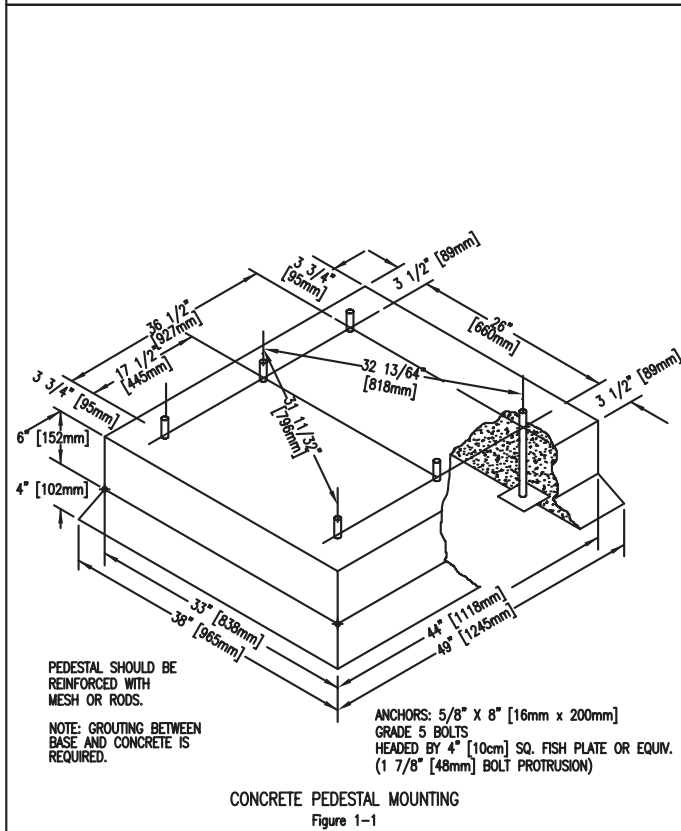
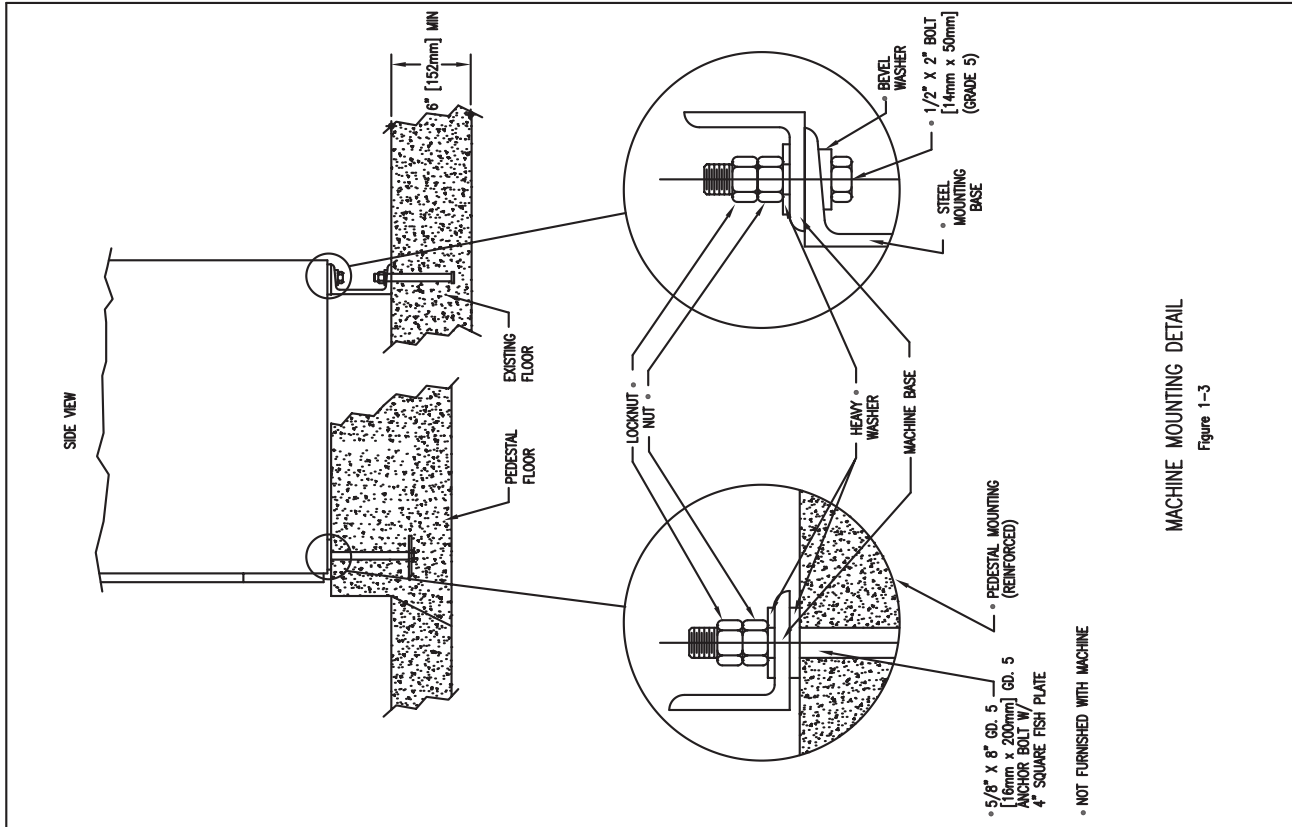

Section 2:

Washer and Dryer
Installation
& Operating
Instructions

Washer Installation

All washers must be installed in accordance with all local, state and national building, electrical, and plumbing codes in effect in the area.

Foundation Requirements

The washer must be securely bolted to a substantial concrete floor, or mounted upon a suitable base which is securely bolted and machine grouted to a substantial concrete floor. Care must be stressed with all foundation work to insure a stable unit, eliminating vibration. All installations must be made on sound concrete floors 6" or thicker. Anchor bolts must be of a quality grade and at least imbedded at minimum of 5" in length and minimum 5/8" diameter.

Mounting

A concrete pad or steel base which elevates the machine 4 to 6 inches above the floor level. To provide easy access to the loading door, it is recommended to allow a minimum of 18" of clearance behind the rear of the machine for service as is shown. SIX (6) bolts are required to mount the washer to the steel base or concrete pad. Grouting where base or machine makes contact with concrete is REQUIRED to achieve 100% surface contact and for warranty to be honored.

NOTE: Premanufactured bases are available from DEXTER factory (see sales dept.)

Mounting Bolts

The following pages illustrate the mounting dimensions for the machine and also show a typical concrete pad arrangement.

NOTE: Mounting bolts should be checked frequently to insure that they remain tight. The machine should be checked with a spinning load to be sure there is no unusual vibration or movement between the machine and the base or floor.

Proper Machine Grout Required Installation

Machine grout must be installed between base (if used) and concrete floor on all side rails and crossmembers. If using a base you must grout between base top and machine frame and all side rails and crossmembers.

Plumbing

Water supply hoses are furnished with each machine. The threaded connections on the hoses are standard garden hose type thread. Separate hot and cold water lines with shut off valves or faucets for inlet hose connections must be provided, maintaining 30 to 120 p.s.i. water flow pressure. Maximum water temperature is 180 degrees.

Drain

The drain outlet tube at the rear of the machine is 3" in outside diameter. Adequate fall for this gravity drain must be maintained for proper drainage.

Protective Film

The machine may have protective adhesive film on the front escutcheon area and the front and side stainless steel panels. The film may be peeled off before putting the machine into service.

Electrical

Dexter single/three-phase 208-240VAC 60 Hz washing machines are intended to be permanently installed appliances. No power cord is provided. The machine should be connected to an individual branch circuit not shared by lighting or other equipment. The connection should be sheathed in liquid tight flexible conduit, or equivalent, with conductors of the proper size and insulation. A qualified technician should make such connections in accordance with the wiring diagram.

Each unit should be connected to an individual branch circuit not shared by lighting or other equipment. Conductors of the proper size and insulation (suggested size below) should be used.

To Make Electrical Connections

Disconnect all power to the washer. Remove screw and lift out the cover located in the upper left corner of the machine (as viewed from the back).

- If power is 208-240-3PH-60Hz, connect L1, L2, L3, and ground. If there is a high leg it must be connected to L3. It is highly recommended to use a TVSS. (see Informative inside Washer)
- If power is 208-240-1PH-60Hz, connect L1, L2, and Ground.

NOTE: It is important that the grounding screw next to the power terminal block TB-1 be connected to a good external ground.

Controls Transformer

The controls transformer is located inside the control trough and steps a range of 208 to 240 volts down to 24 volts. There are two terminals on the controls transformer for the primary (incoming) power. Use the terminal marked "208V" for power supplies between 200 and 215 volts. Use the terminal marked "230V" for power supplies between 216 and 240 volts.

NOTE: transformer must be set at proper tap for proper operation.

Electrical Connections

Electrical power connections are made to the small terminal block located in the rear of the control trough. The terminal block is accessed by opening the top panel of the machine.

- 1 Phase or 3 Phase connections
- 208-240 volts, 60 Hz.
- 3 wire plus ground
- Suggested Minimum Wire Size -- 12 Ga.

Fusing Requirements:

Dual element time delay fuse or equivalent breaker of amperage specified below.

- 1 Phase or 3 Phase 15 amp
- WCS450XB-12

Rotation in extract as viewed through glass door at front of washer models WSVD-30 will be counter- clockwise.

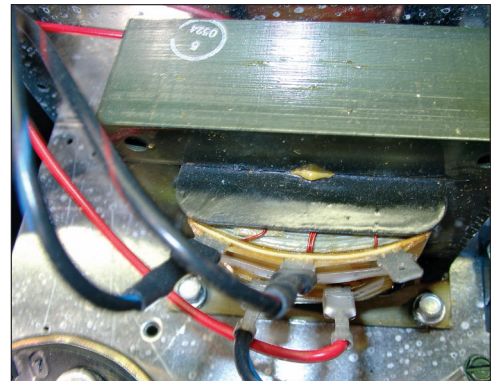
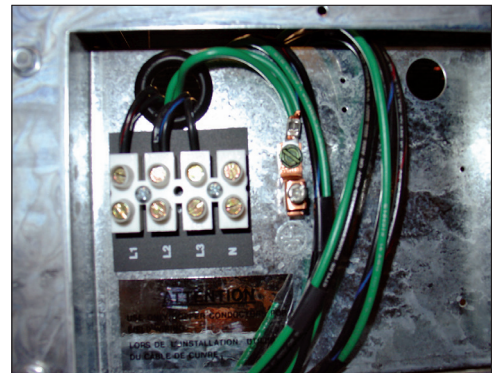

WARNING

Always disconnect electrical power to the machine before performing any adjustments or service.

Dryer Installation

All commercial dryer installations must conform with local applicable local codes or in the absence of local codes, with the National Fuel Gas Code ANSI Z223.1A-1988. Canadian installations must comply with current standard CAN/CGA-B149(.1 or .2) Installation Code for Gas Burning Appliances or Equipment, and local codes if applicable. The appliance, when installed, must be electrically grounded in accordance with the National Electric Code, ANSI/NFPA No. 70-1990, or when installed in Canada, with Standard CSA C22.1 Canadian Electrical Code Part 1.

Installation Clearances:

This unit may be installed at the following alcove clearances.

1. Left side- 0"
2. Right side- 0"
3. Back- 18" (Certified for 6" clearance: however 18" is required to clean, service, and maintain the dryer).
4. Front- 48" to allow use of dryer.
5. Top- Refer to figure labelled "Vertical Clearance Dimensions".
6. Floor- This unit may be installed upon a combustible floor.

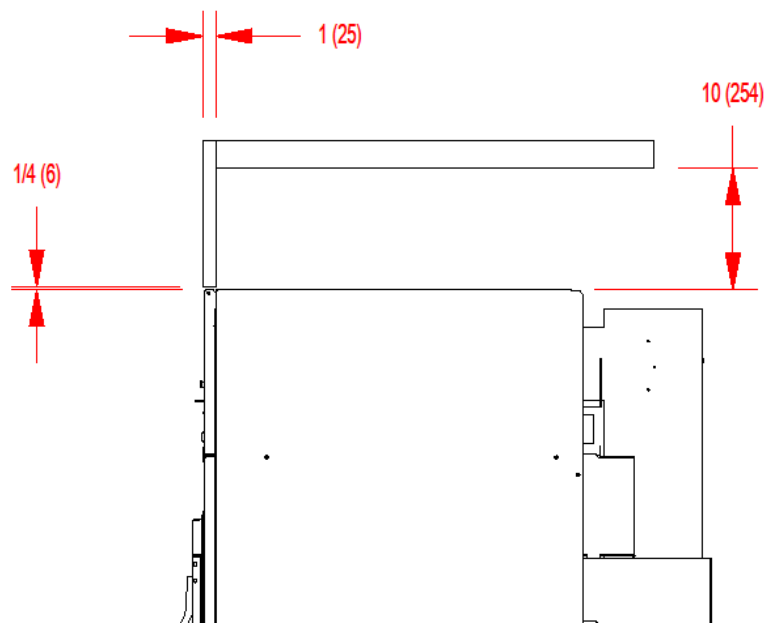

Vertical Clearance Dimension

Makeup Air

Adequate makeup air must be supplied to replace air exhausted by dryers on all types of installations. Provide a minimum of 1 square foot of makeup air opening to the outside for each dryer. This is a net requirement of effective area. Screens, grills, or louvers which will restrict the flow of air must be considered. Consult the supplier to determine the free, area equivalent for the grill being used.

The source of makeup air should be located sufficiently away from the dryers to allow an even air flow to the air intakes of all dryers. Multiple openings should be provided.

NOTE: The following considerations must be observed for gas dryer installations where dry cleaners are installed. The sources of all makeup air and room ventilation air movement to all dryers must be located away from any dry cleaners. This is necessary so that solvent vapors will not be drawn into the dryer inlet ducts. Dry cleaner solvent vapors will decompose in contact with an open flame such as the gas flame present in clothes dryers. The decomposition products are highly corrosive and will cause damage to the dryer ducts and clothes loads.

Electrical Requirements

The electrical power requirements necessary to operate the unit satisfactorily are listed on the serial plate located on the back panel of each dryer. The electrical connection should be made to the terminal board on the rear of the unit using #12 AWG.

It is absolutely necessary that the dryer be grounded to a known ground. Individual circuit breakers for each dryer and washer are required. Use 15A circuit breakers for the 208-240VAC dryer. (See Dryer Specification Page for Electric Heated Models)

Gas Requirements

GAS REQUIREMENTS. The complete gas requirements necessary to operate the dryer satisfactorily are listed on the serial plate located on the back panel of the dryer and in the specifications section of this manual. The inlet gas connection to the unit is 1/2-inch pipe thread. However, the size of the piping to supply the dryer should be determined by reference to the National Fuel Gas Code ANSI Z223.1A and consultation with the local gas supplier. An individual gas shutoff valve is recommended for each dryer and may be required by local code (not supplied). A joint compound resistant to the action of liquefied petroleum gases should be employed in making pipe connections. A 1/8-inch NPT plugged tapping, accessible for test gage connection, must be installed immediately upstream of the gas supply connection to the dryer. A drip tee is provided in the unit gas piping to catch dirt and other foreign articles. All pipe connections should be checked for leakage with soap solution. Never check with an open flame. For altitudes above 2,000 feet (610m), it is necessary to derate the BTU input. Contact your local distributor for instructions. L.P. gas conversion kits are available for this dryer. Contact your local distributor.

CAUTION: The dryer must be disconnected from the gas supply piping system during any pressure testing of that system. Do not expose the dryer's gas control valve to testing pressure.

Burner Set-Up

All gas burner manifolds should be checked for proper gas pressure while burning. Dryer burners should be set at 3.5 W.C. for Natural Gas while burner operating.

Exhaust Installation

Exhausting of the dryer should always be planned and constructed so that minimum air restrictions occur. (Refer to Figure on dryer exhausting). Maximum static back pressure allowed at rear exit of dryer is .3 SBP.

Any restriction due to pipe size or type of installation can cause slow drying time, excessive heat, and lint build up in system and the room. From an operational standpoint, incorrect or inadequate exhausting can cause cycling of the high limit thermostat which shuts off the main burners and results in inefficient drying.

Individual exhausting of the dryer is recommended. All heat, moisture, and lint should be exhausted outside by attaching a pipe of the proper diameter to the dryer adapter collars and extending it out through an outside wall. This pipe must be very smooth on the inside, as rough surfaces tend to collect lint which will eventually clog the ducts and prevent the dryer from exhausting properly. All elbows must be smooth on the inside. All joints must be made so the exhaust end of one pipe is inside the next one downstream. The addition of an exhaust pipe tends to reduce the amount of air the blower can exhaust. This does not affect the dryer operation if held within practical limits. For the most efficient operation, it is

recommended that no more than 14 feet of straight 6" diameter pipe with two right angle elbows be used. When more than two elbows are used, two feet of straight pipe should be removed for each additional elbow.

If the exhaust pipe passes through a wall, a metal sleeve of slightly larger diameter should be set in the wall and the exhaust pipe passed through this sleeve. This practice is required by some local codes and is recommended in all cases to protect the wall. This type of installation should have a means provided to prevent rain and high winds from entering the exhaust when the dryer is not in use. A hood with a hinged damper can be used for this purpose. Another method would be to point the outlet end of the pipe downward to prevent entrance of wind and rain. In either case, the outlet should be kept clear by at least 24" of any objects which would cause air restrictions.

Never install a protective screen over the exhaust outlet.

When exhausting a dryer straight up through a roof, the overall length of the duct has the same limits as exhausting through a wall. A rain cap must be placed on top of the exhaust and must be of such a type as to be free from clogging. The type using a cone shaped "roof" over the pipe is suitable for this application. Exhausting the dryer into a chimney or under a building is not permitted. In either case there is a danger of lint buildup which can be highly combustible.

Installation of several dryers where a main discharge duct is necessary, will need the following considerations for installation.

NOTE: A small diameter duct will restrict air flow, a large diameter duct will reduce air velocity, both contributing to lint build up, An inspection door should be provided for periodic clean-out of the main duct.

NOTE: STATIC BACK PRESSURE should be a maximum of 0.3 in. w.c (7.6 mm w.c) at the rear exhaust outlet of the dryer. If multiple dryers are connected to the common duct, ensure the back draft damper is installed properly.

NOTE: The following illustration shows the various round main duct diameters to use with the individual dryer ducts. The main duct can be rectangular or round, provided adequate air flow is maintained. For each individual cylinder the total exhausting (main discharge duct plus duct outlet from the dryer) should not exceed the equivalent of 14 feet and two elbows. The diameter of the main discharge duct at the last dryer must be maintained to exhaust end.

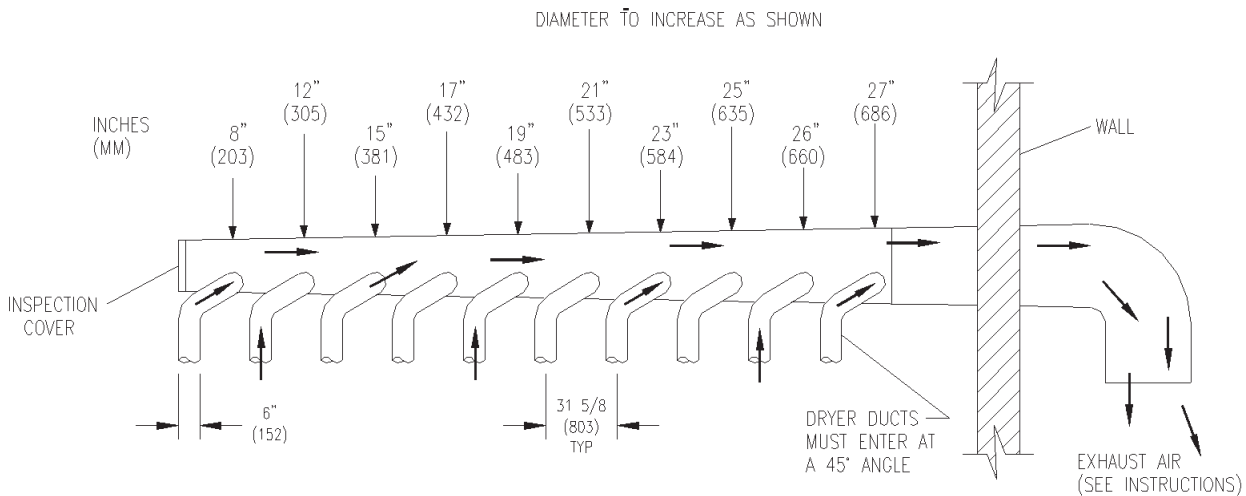

Washer Operating Instructions

Washer Emergency Stop / Safety Door Lock

This machine is equipped with a Safety Door Lock that locks the door closed from when the cycle is started until the cycle is complete. The door lock prevents opening the door for up to 3 minutes if the power is interrupted during the cycle.

The Emergency Stop button pauses the washer and allows the door to be opened during the cycle after the Safety Door Lock releases. When the Emergency Stop button is pressed an alarm will sound and the display will begin counting down from "3". If the button is released before 3 seconds elapse, the alarm will stop and the cycle will continue normally. If the Emergency Stop is held down for 3 seconds, the display will count down to "0" and the washer will begin stopping movement and water flow and begin draining water from inside the washer. Though the machine may stop wash movement quickly, it may take up to 3 minutes for the door to unlock. During that time the alarm will continue to sound. When the alarm stops, the door may be opened. The washer may be restarted by closing and latching the door, and pressing the Start button. If the washer was stopped during final extract, the cycle will be ended. If the washer is stopped for more than 1 hour, the cycle will be terminated. If the emergency stop is triggered a second time during the cycle, the cycle will be terminated.

Starting the Washer

- A. Load the clothes loosely in the cylinder and latch the door securely. Be sure clothing does not get caught between the door gasket and tub front when closing the door.
- B. Pour low-sudsing powdered detergent in the amount shown on following page into the detergent dispenser on front of the machine. Rinse conditioners may also be added to the dispenser. The correct location is shown on the dispenser lid.

NOTE: To close the door the handle must be in the horizontal position and then moved to the vertical position . After moving the door to the closed position, the handle must be turned down to the vertical position to latch the door for machine operation.

- C Using the TEMPERATURE SELECT buttons on the front, select the desired temperature. If temperature pricing is being used you will display price changes as you push the desired temperature selection. This selection must be made before inserting coins to satisfy temperature price selected. If coins or value are added after extended plus cycle vend price is met it will be lost without credit. If water temperature pricing feature is active and vend price met and machine started the customer may change temperature selections of equal to or lower priced temperature selections already inserted into machine.
- D. Insert coins, tokens or activate card reader to meet displayed vending price. The washer will start, the display will read "Press Start" and the green "on" led will glow. The green start pushbutton must be pushed to start cycle time countdown and machine starting to run. "Close Door" will display if loading door is not closed and handle locked.
- E. If utilizing ADD PLUS CYCLE option the front display will scroll, "Extend Wash" .25(example), amount to be added. User will have 1 minute to insert proper amount to activate this option.

- F. At the correct time in the wash bath cycle the "ADD BLEACH" will come on indicating the time and showing a diagram of the location for adding bleach if desired. The timing is 2 1/2 minutes after start of wash bath the light will come on and stay on for 2 1/2 minutes or end of wash bath .

End of Cycle

When the cycle is completed, the end of cycle buzzer will sound and the "on" light will go off. The loading door can now be opened by turning the door handle to the indicated position and pulling. Leave the clothes door open when the machine is not in use. Also at the end of cycle the display will reset to the original amount required to start.

Detergent Measurements



Triple Load SWD Washer

Dryer Operating Instructions

DESCRIPTION OF DRYER CONTROL

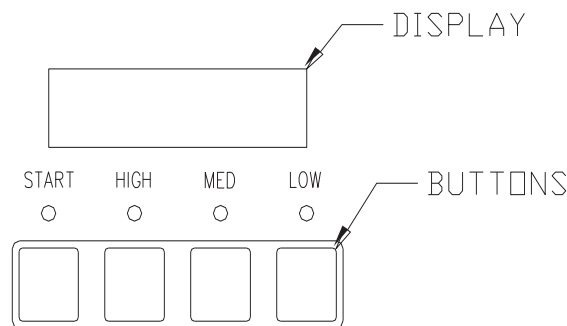

STARTING THE DRYER

1. The display on the dryer control will show the required vend amount when in idle mode. Once the door is opened it will prompt the user to add money. Load clothes into the dryer. Close the door completely.
2. Deposit coins equal to or greater than the displayed vend price. The display on the control will prompt the user to choose a drying temperature.
3. Select the drying temperature by pressing the appropriate button for "HIGH", "MED" (medium) or "LOW". This will turn on the red indicator light showing the selected temperature.
4. Press the "START" button to start dryer. This will turn on the green indicator light. The drying time purchased is now displayed. The colon begins flashing to indicate that the timer is counting down.

RUNNING THE DRYER

- Opening the door will stop the dryer, but the timer will continue to count down. The dryer will restart, if time has not expired, upon closing the door and pressing the "START" button.
- Selected temperature may be changed at any time (unless Temperature Pricing feature is activated).
- Running time may be extended by depositing coins and pressing the "START" button. Unless time has expired, the controller will accept coins whether or not the original vend price is equaled.
- If time has run out, the dryer must be restarted as if it was at the beginning of drying the load, which requires meeting or exceeding the vend price.
- Clothes should be removed promptly after the cycle is completed to prevent excessive wrinkling.
- Cool-down time (owner programmable) is always part of the cycle time purchased by the customer. For example, if the cool-down time is 2 minutes, then the last 2 minutes of the cycle will have no heat.

IMPORTANT: Opening the loading door will stop the dryer. However, the computer will continue to count down the time.

TRANSIENT VOLTAGE SURGE SUPPRESSORS

Like most electrical equipment your new machine can be damaged or have its life shortened by voltage surges due to lightning strikes which are not covered by factory warranty. Local power distribution problems also can be detrimental to the life of electrical components. We recommend the installation of transient voltage surge suppressors for your new equipment. These devices may be placed at the power supply panel for the complete installation and don't require an individual device for each machine.

These surge protectors help to protect equipment from large spikes and also from small ongoing spikes in the power that occur on a day to day basis. These smaller surges can shorten overall life of electrical components of all types and cause their failure at a later date. Although they can't protect against all events, these protective devices have a good reputation for significantly lengthening the useful life of electronic components.

Electronic Components are helped to have a longer useful life when they are supplied with the clean stable electrical power they like.

We are including the following names and links to a few suppliers of these devices for those who don't currently have a source.

MANUFACTURER	LINK
MCG Surge Protection	mcgsurge.com
Eaton Corporation	eaton.com/us/en-us
Schneider Electric	se.com/us/en
Asco Power Technologies	ascopower.com/us/en
Emerson Electric Co.	emerson.com/en-us

Section 3:

Washer and Dryer Programming Instructions

PROGRAMMING INSTRUCTIONS:

The washer control can be programmed to prompt the user for alternate vend prices, change washer cycle times, temperatures, and many other options. This can be accomplished in two ways:

1. Manual programming utilizing the "START", "HOT", "WARM", and "COLD" buttons
2. USB download

For instructions on using the USB download feature, please contact your local Dexter distributor.

MANUAL PROGRAMMING:

The washer must be in idle mode for the manual programming menus to be accessed. Idle mode is when the washer is not actively running a wash cycle and the vend price is displayed on the screen.

To enter the manual programming mode, the programming button needs to be pressed for 1 second. The control should display "PROGRAMMING MENU". There are two programming buttons on this washer. One is on the control board behind the front panel and an auxiliary button is inside the coin vault.

The figure below shows the location of the programming button and USB port inside of the coin vault.

Figure 1

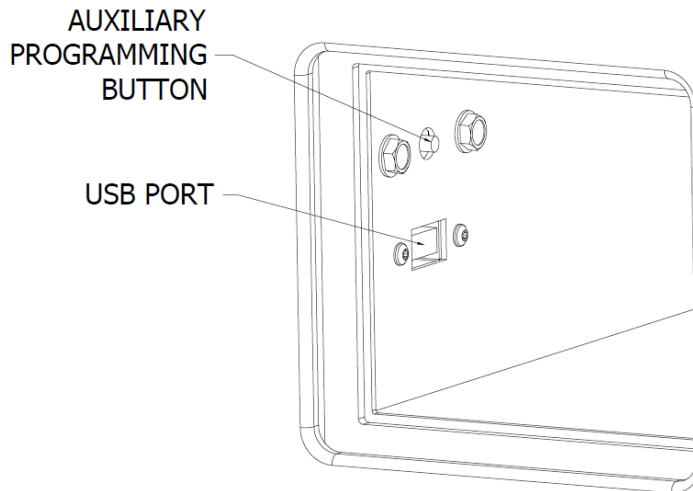

When manual programming mode is entered, the "START", "HOT", "WARM", and "COLD" buttons perform alternate functions.

Button Name	Alternate Function in Programming Mode
Start	Becomes the action to accept the displayed option or the "Enter" key
Hot	Becomes the action to move UP through displayed options (Press & hold for accelerated scrolling)
Warm	Becomes the action to move DOWN through displayed options (Press & hold for accelerated scrolling)
Cold	Becomes the action to move back a step (1 press) or EXIT from programming mode (press for 3 seconds)

Programing Selection:

These alternate functions allow the user to move through a menu of options to choose various program-able settings. Figure 2, shown below, shows the top level menu. Choosing an option from the top level menu will then display the next level of options (the sub menu).

Figure 2

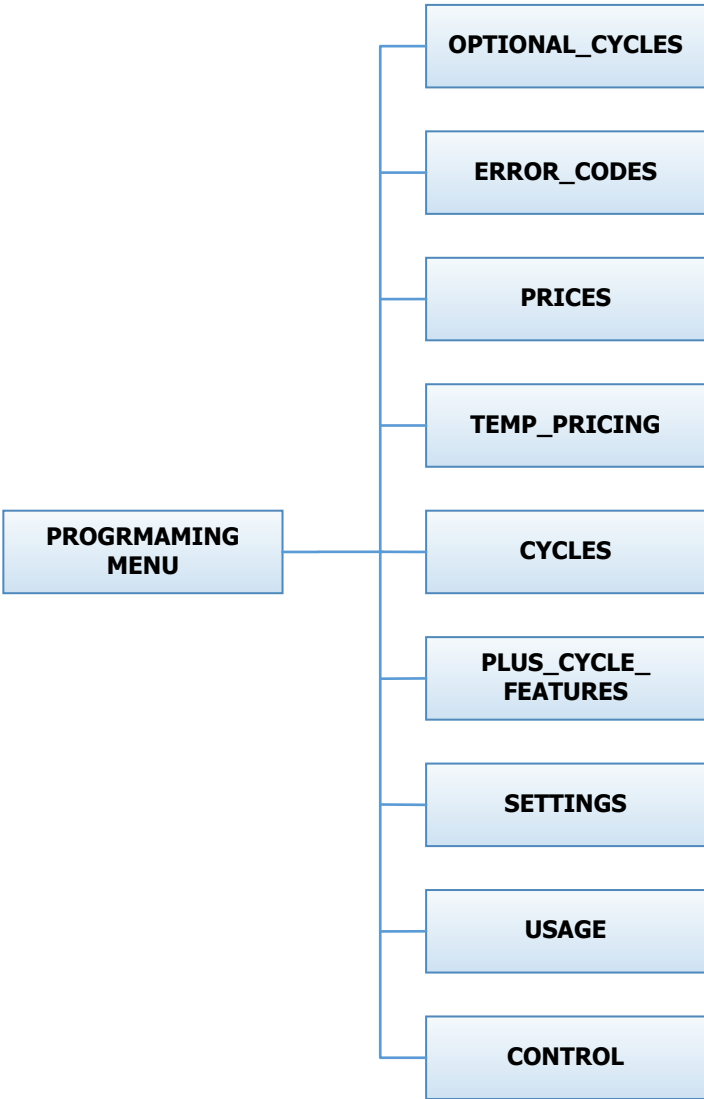

Optional Cycles Option:

This option allows the user to select the different test and short-cycle options.

Figure 3

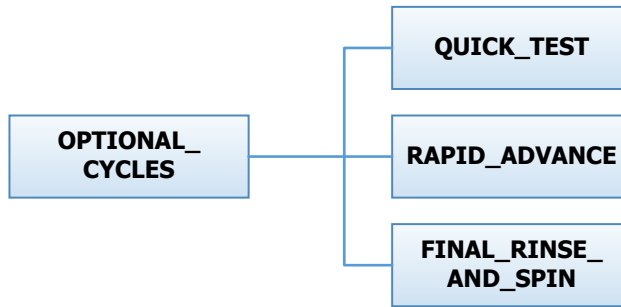

Quick Test Option:

When the Quick Test Option is chosen, the washer will begin a shortened wash cycle without the displayed vend price being met. The purpose of this shortened cycle is to test all major components for proper operation.

Error Codes should all function normally during this test. The display will show customer prompts in a similar way to a normal wash cycle. Exceptions to this are that the "ADD BLEACH" prompt will not occur because of reduced cycle time. Final Extract speed is specific to the customer's programming.

Bath	Bath Cycle Time (min.)	Water Temp	Delay Fill	Spin Time (min.)
Prewash	0	n/a	n/a	0
Wash	1	Hot	On	2
Extended Wash	0	n/a	n/a	n/a
Rinse	1	Cold	On	0
Final Rinse	0	Cold	On	n/a
	n/a	n/a	n/a	0
Extra Rinse Bath	0	n/a	n/a	n/a
Final Extract Spin	n/a	n/a	n/a	4

Rapid Advance Option:

Similar to the Quick Test, when the Rapid Advance Option is chosen, the washer will begin a wash cycle without the displayed vend price being met. However, in this case, it will be a normal default cycle with an additional feature available. The "START" button LED will flash, prompting the user that, when pressed, the washer shall rapid advance to the next step in the cycle. The display will show "ADVANCE" when the cycle is advancing. The water level needs to be empty before this advance occurs. During the time waiting for the tub to empty, the "ADVANCE" prompt will be held on the display and the START pushbutton LED stops flashing. The Rapid Advance shall allow the tub to empty of water and the tub to stop before beginning either spin or the next bath.

The Rapid Advance mode can be exited by pressing the programming button. This will end the cycle.

When the Rapid Advance mode is used, the cycle time will no longer be correct. By skipping steps with Rapid Advance, the door may not open immediately at the end of the cycle.

Final Rinse and Spin Option:

“Final Rinse and Spin” will begin only the Final Rinse Bath and Final Spin portions of the cycle without the displayed vend price being met. The configured temperature, cycle times, and spin speed for the Final Rinse Bath and Final Spin settings will be used when this option is selected.

NOTE: Error Codes should all function normally during this test.

Error Code Historical Log:

The last five occurring error codes will be stored in the control with a time and date stamp. The purpose of this option is only to observe the history of these code occurrences (no changes can be made).

The time is based off the Real Time Clock, but potentially shifted by the user’s manual programming changes (Shift Hours option) and/or network time override. As additional error codes occur, the oldest of the five logged codes is cleared from memory.

Figure 4

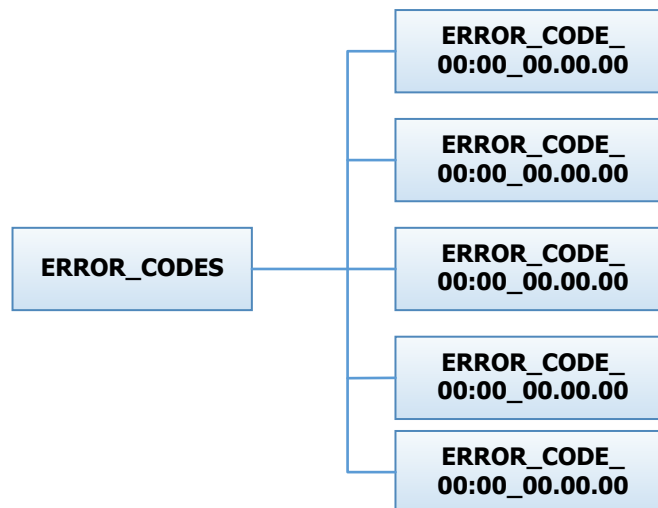

Prices Option:

This option allows the user to set values for coin acceptor inputs and to set the vend price. It also allows the user to return the values to factory defaults. "RIGHT COIN" and "LEFT COIN" are the two possible inputs from coin acceptors.

"SET VEND" is the actual Base Vend Price (or Vend Price A) that is shown on the control display. After changing prices using the "UP" or "DOWN" buttons, the "ENTER" button must be pressed again for the control to store the changes that have been made.

To reset either the coin acceptor inputs or the vend price to factory default, press "ENTER" when the "DEFAULT" prompt is shown. Press "ENTER" again when the "RESET" prompt is shown to confirm the action.

Figure 5, shown below, shows the sub menu options for Prices:

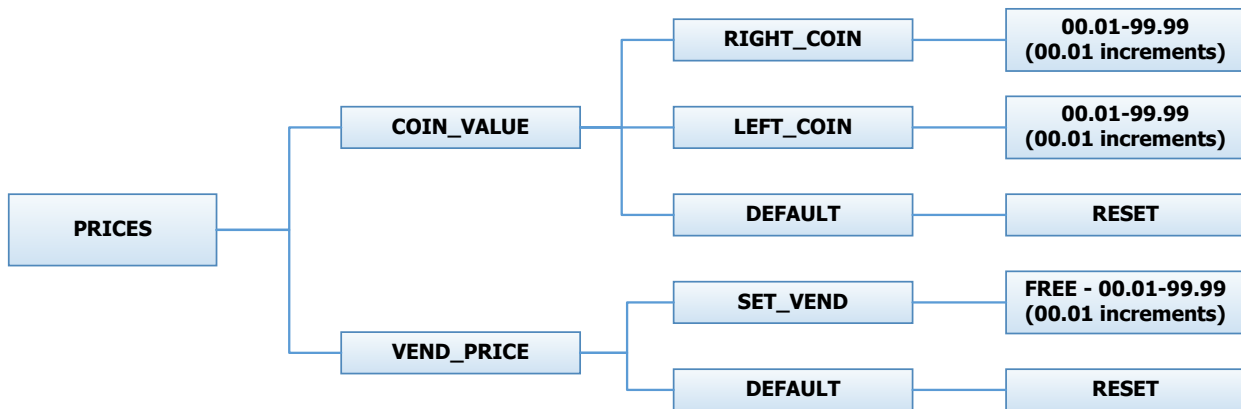

Temp Pricing Option:

The Temperature Pricing option allows for the user to prompt the customer for varying vend prices based on the water temperature the customer selects. If a value other than 0 is programmed for either the "WARM ADDER" or "HOT ADDER", the feature becomes active. The programmed value is added to the base vend price when that particular water temperature is chosen.

When the customer adds coins to meet the adjusted vend price and starts the washer, the temperature selections available to the customer are limited to those with vend prices equal to or less than the amount entered.

Figure 6, shown below, shows the sub menu options for Temp Pricing:

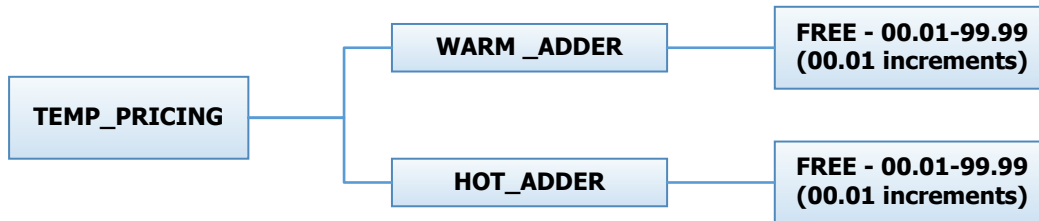

Cycles Option:

This option allows the user to set the bath time and spin time for the "Wash" bath. It also allows the user to set bath time, water temperature, and spin time for "Rinse" and "Final rinse" baths. (Water temperature for the "Wash" bath is chosen by the customer using the "HOT", "WARM" and "COLD" buttons on the front of the machine). For the "Final Spin" it also allows the user to set the spin speed (see additional description below).

It also allows the user to return the values to factory defaults. To reset all values in the Cycles option to factory default, press "ENTER" when the "DEFAULT" prompt is shown. Press "ENTER" again when the "RESET" prompt is shown to confirm the action.

Figure 7, shown below, shows the sub menu options for Cycles:

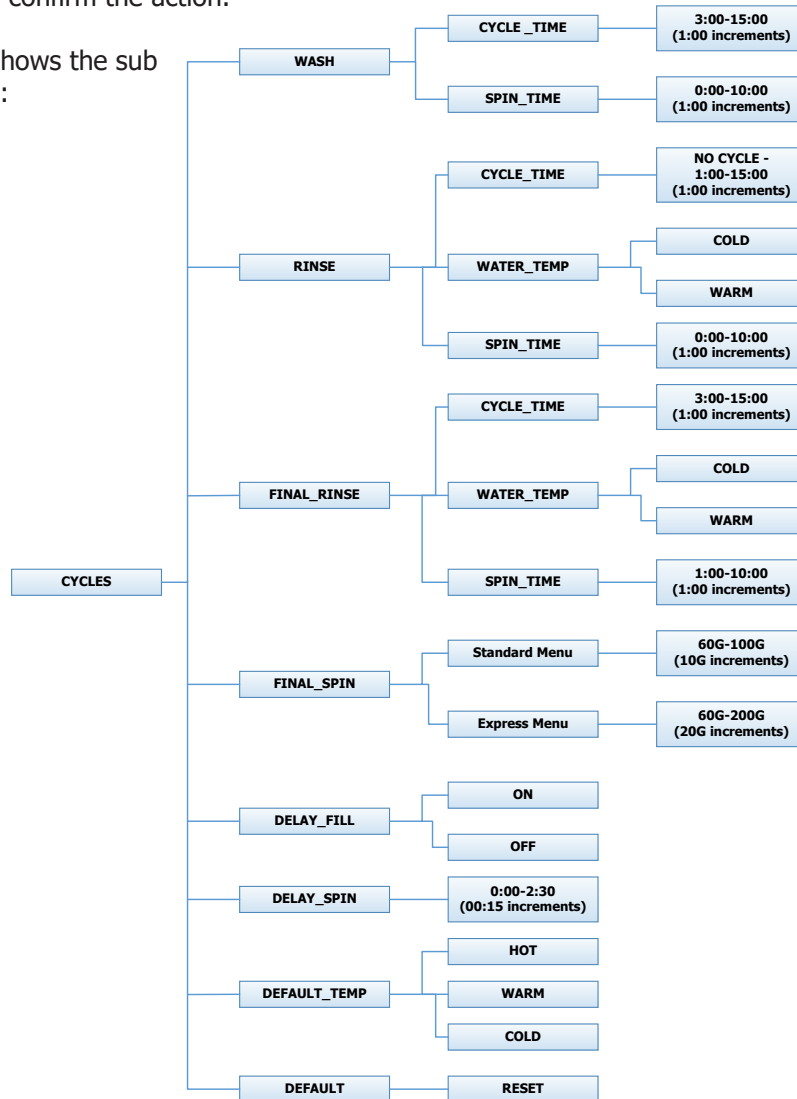

Bath	Bath Cycle Time (min.)	Water Temp	Delay Fill	Spin Time (min.)
Prewash	0	Cold	Off	0
Wash	9	Warm	Off	0
Extended Wash	0	n/a	n/a	n/a
Rinse	4	Cold	Off	1
Final Rinse	5	Cold	Off	n/a
Extra Rinse Spin	n/a	n/a	n/a	0
Extra Rinse Bath	0	Cold	Off	n/a
Final Extract Spin	n/a	n/a	n/a	6

Final Spin:

The washer "Final Spin" is the spin that occurs after all selected baths & intermediate spins have been completed. It is a higher spin speed than previously occurring intermediate spins. The benefit of this higher spin speed is that more water is extracted from the wash load, which minimizes the drying time needed. However, in some cases, if the Dexter installation guidelines are not followed properly, it may be necessary to reduce the spin speed of the "Final Spin". The control allows for this to occur, based on the menu shown above.

The Final Spin can be adjusted in increments of 10 G for washers with a 100G maximum spin speed and increments of 20 G for washers with a 200G maximum spin speed. The factory default final spin speeds are the maximum values.

Model	Adjustable Final Spin Range
T300	60G to 100G
T350 or T350 SWD	60G to 200G
T400	60G to 100G
T450 or T450 SWD	60G to 200G
T600	60G to 100G
T750 or T750 SWD	60G to 200G
T900	60G to 100G
T950	60G to 200G
T1200	60G to 100G
T1450	60G to 200G

Delay Fill:

In some applications, the amount of available water pressure is limited. In these cases, the washer may not be able to fill the tub in sufficient time to allow for effective washing performance. For this situation, the control has a "Delay Fill" option that can be chosen based on the menus above.

When the Delay Fill option is "On", the water valves shall be turned on, the washer shall agitate, but the cycle time shall be paused. The washer shall continue in this state until the proper water level is reached. Once the proper water level is reached, the cycle shall continue. A single selection of "On" or "Off" shall apply to all baths in the cycle. The factory default setting is "Off".

Delay Spin:

In some applications, the amount of drain capacity is limited. In these cases the washer cannot empty the tub in sufficient time to allow for a spin cycle to occur. For this situation, the control has a "Delay Spin" option that can be chosen based on the menus above.

When a time value (other than 0) is programmed for the Delay Spin option, the end of each bath will be extended by the selected time. Therefore, extra time will be allowed for the drain valve to be open and compensate for slow drain capacity. The factory default setting is 0 seconds.

Default Temp:

The "Default Temp" option allows the user to choose which water temperature ("Hot", "Warm", or "Cold") will be active during Idle mode. The customer can, choose other temperatures for the wash bath based on other options described in this manual.

Plus Cycle Options:

The Plus Cycle options allow for the user to prompt the customer for varying vend prices based on additional wash baths chosen. In general, the user can program the additional wash baths in a similar manner to what was described in the "Cycles" Options section.

It also allows the user to return the programmable values to the factory default setting. No plus cycle options are active using the factory default. To reset all values in the Plus Cycles option to factory default, press "ENTER" when the "DEFAULT" prompt is shown. Press "ENTER" again when the "RESET" prompt is shown to confirm the action.

Figure 8, shown below, shows the next level options for Plus Cycle Options:

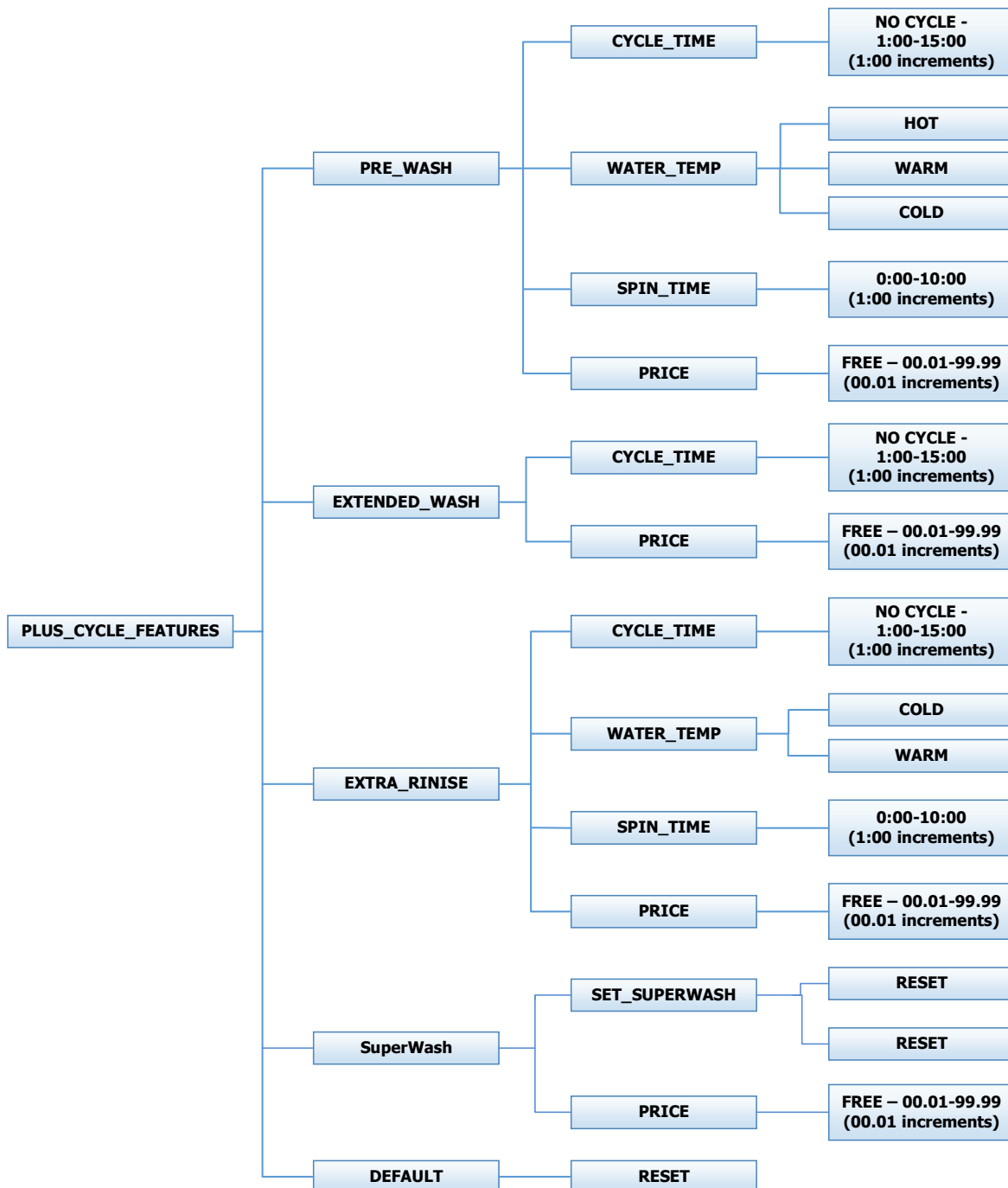

Pre-Wash:

If the user programs a "CYCLE TIME" for Pre-Wash other than 0 ("NO CYCLE"), the feature becomes active. However, the customer will not be prompted to pay an additional vend price for Pre-Wash unless the user programs the Price to a value other than 0 ("FREE").

With the Pre-Wash feature active, an additional bath and, optionally, an additional spin, will occur before the standard Wash bath described in the Cycles Options section.

With the Pre-Wash feature active and a Price value programmed, the customer will be prompted to add additional coins if they wish to purchase the Pre-Wash feature. This will occur after they have entered coins to meet the Base Vend price. If the customer does not meet the vend price of the Pre-Wash feature, the prompt will time out and the Pre-Wash bath will not occur.

Extend Wash:

If the user programs an "EXTEND TIME" for Extend Wash other than 0, the feature becomes active. However, the customer will not be prompted to pay an additional vend price for Extend Wash unless the user programs the Price to a value other than 0 ("FREE").

With the Extend Wash feature active, the standard Wash bath described in the Cycles section will be extended for the additional time selected.

With the Extend Wash feature active and a Price value programmed, the customer will be prompted to add additional coins if they wish to purchase the Extend Wash feature. This will occur after they have pressed the "Start" button to begin the normal Wash cycle. If the customer does not meet the vend price of the Extend Wash feature, the prompt will time out and the additional time will not be added to the Wash bath.

Extra Rinse:

If the user programs a "CYCLE TIME" for Extra Rinse other than 0 ("NO CYCLE"), the feature becomes active. However, the customer will not be prompted to pay an additional vend price for Extra Rinse unless the user programs the Price to a value other than 0 ("FREE").

With the Extra Rinse feature active, an additional bath and, optionally, an additional spin, will occur after the standard Final Rinse bath described in the Cycles Options section.

With the Extra Rinse feature active and a Price value programmed, the customer will be prompted to add additional coins if they wish to purchase the Extra Rinse feature. This prompt will occur during the standard Final Rinse bath. If the customer does not meet the vend price of the Extra Rinse feature, the prompt will time out and the Extra Rinse bath will not occur.

SuperWash:

If the user programs SuperWash to "On", the feature becomes active. However, the customer will not be prompted to pay an additional vend price for "SuperWash" unless the user programs the Price to a value other than 0 ("Free"). With the "SuperWash" feature active, any combination of the "Pre-Wash", "Extend Wash", or "Extra Rinse" features, of which that are also active, will be automatically implemented during the cycle. No additional prompting for vend will occur for the individual features during the cycle. For example, if "Pre-Wash", "Extra Rinse", and "SuperWash" options are active and "SuperWash" price is met, the "Pre-Wash" and "Extra Rinse" features will automatically occur during the cycle. The control will not prompt for "Extra Rinse" vend at the normal prompting time of the cycle.

With the "SuperWash" feature active and "Price" value programmed, the customer will be prompted to add additional coins if they wish to purchase the "SuperWash" feature. This will occur after they have entered coins to meet the Base Vend price. If the customer does not meet the "SuperWash" vend price, the prompt will time out and the configured combination of "Pre-Wash", "Extend Wash", or "Extra Rinse" features that make up SuperWash will not occur. The "SuperWash" price will take priority over the individual pricing of the "Pre-Wash", "Extend Wash", and "Extra Rinse" features that are active.

Settings Options:

The Settings options allow for the user to make various programming changes to change how the control operation affects the customer. See below for detailed information on each next level option.

It also allows the user to return the programmable values to the factory default setting. To reset all values in the Settings options to factory default, press "ENTER" when the "DEFAULT" prompt is shown. Press "ENTER" again when the "RESET" prompt is shown to confirm the action.

Figure 9, shown below, shows the next level options for Settings Options:

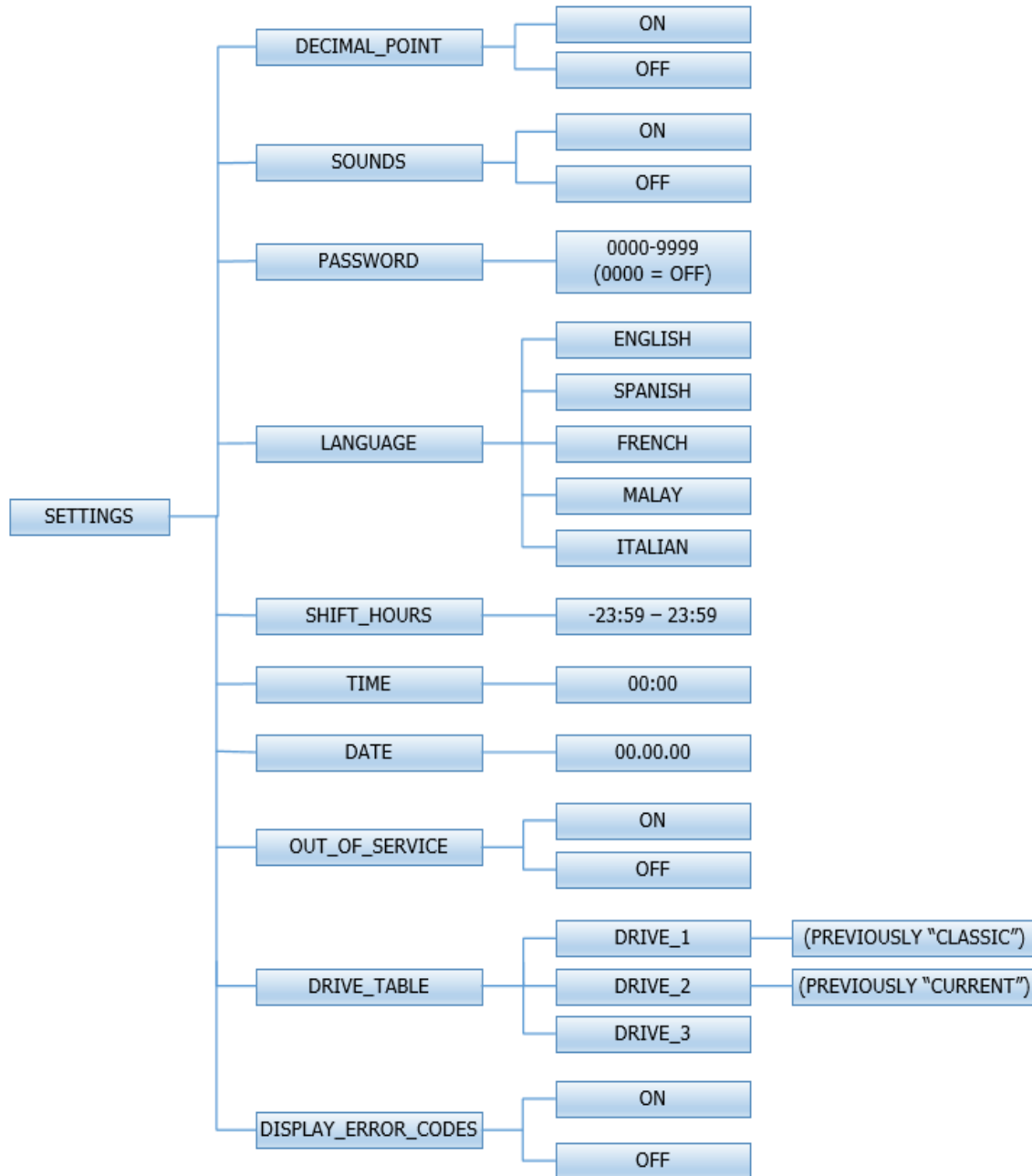

Decimal Point:

If the user programs the Decimal Point to "OFF", control display will not show a decimal point on any vend price values. The factory default is "ON".

Sounds:

If the user programs the Sounds to "OFF", the control will not sound the enunciator at the end of a wash cycle. The factory default is "ON".

Password:

If the user programs the Password to any value other than '0000', the control will prompt the user to enter a password (the programmed value) before manual programming can be accessed. The factory default is "0000" (no password).

NOTE: that if the user forgets the Password, it can be reset to factory default (no password), by performing a hard reset on the control. Please refer to the appropriate section of this manual to understand how to perform a hard reset.

The individual digits of the Password can be set by using the "UP" or "DOWN" buttons to change the number that is flashing. Once the desired number is chosen for a single digit, press the "ENTER" button to move to the next one. Once all four desired digits are chosen, the "ENTER" button must be held down for 3 seconds to confirm that the complete password should be set.

Language:

The control uses English for the default language of the customer prompts. Alternatively, the user can choose Spanish, French, Malay, or Italian for the customer display prompts. However all other prompts such as Manual Programming, USB Programming, and any Error Codes will still display in English.

Shift Hours:

The control uses a Real Time Clock (RTC) to internally track the time and date. The RTC continues operation even if the control loses external power. The RTC is set for Central Standard Time and no daylight savings.

Because the machine may be located in another time zone, the user can choose to create an alternate time & date that tracks in parallel to the RTC. When this alternate time is chosen, or shifted from the RTC, the alternate time will be used to, for example, track error code occurrences and set time-of-day pricing changes.

The hours in "SHIFT HOURS" can be set by using the "UP" or "DOWN" buttons to change the number that is flashing. Once the desired hour shift is chosen, press the "ENTER" button to move to the minutes. Once the hours and minute shift are both chosen, the "ENTER" button must be held down for 3 seconds to confirm that the complete shifted time is set.

Time:

The control uses a Real Time Clock (RTC) to internally track the time and date. The RTC continues operation even if the control loses external power. The RTC is set for Central Standard Time and no daylight savings. However, if a problem occurs and the RTC time is not accurate, it can be reset to the current time using this option.

The hours in "TIME" can be set by using the "UP" or "DOWN" buttons to change the number that is flashing. Once the desired hour is chosen, press the "ENTER" button to move to the minutes. Once the hours and minute are both chosen, the "ENTER" button must be held down for 3 seconds to confirm that RTC is meant to be reset to the complete entry.

Date:

The control uses a Real Time Clock (RTC) to internally track the time and date. The RTC continues operation even if the control loses external power. The RTC is set for the current date. However, if a problem occurs and the RTC date is not accurate, it can be reset to the current date using this option.

The day of the month in "DATE" can be set by using the "UP" or "DOWN" buttons to change the number that is flashing. Once the desired day of the month is chosen, press the "ENTER" button to move to the month of the year. Once the desired month of the year is chosen, press the "ENTER" button to move to the year. Once the day, month, and year are all chosen, the "ENTER" button must be held down for 3 seconds to confirm that RTC is meant to be reset to the complete entry.

Out of Service:

The control can be put into an Out-of-Service mode via manual programming. When the mode is "ON", the control will scroll "OUT OF SERVICE" on the display. The machine will not react to any vend input and will not operate when in this mode. The factory default is "OFF".

Drive Table:

The control knows what model of washer it is installed in based on various inputs including information it receives from the Variable Frequency Drive (VFD). However, because multiple VFD's can be used on the same model, depending on when it was manufactured, the "DRIVE TABLE" option is available. "DRIVE ERROR 1" will display on the control when the Drive Table setting does not match the appropriate VFD in the washer.

- Choose "Drive 3" for C4 models (ex. WC0600XA-12EC4X-)
- Choose "Drive 2" for C1, C2, or C3 models (ex. WC0600XA-12EC2X-)
- Choose "Drive 1" for WCAD models (ex. WCAD40KCS)

Usage Menu:

The Usage menu allows for the user to track data about machine usage. See below for detailed information on each sub menu option.

Figure 10, shown below, shows the sub menu options for Usage:

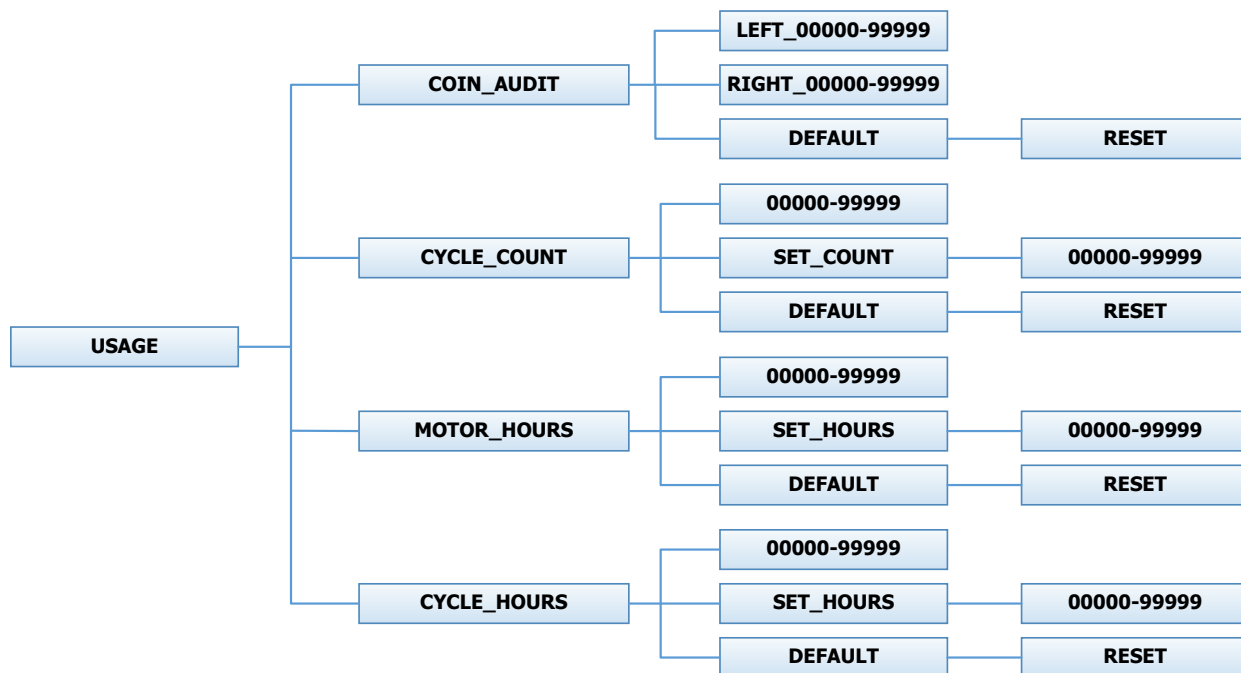

Coin Audit:

The coin audit field shows the accumulation of coin pulses that were sent to the control over each of the left and right coin inputs. **NOTE:** that this is a count of coin pulses, not an accumulated report of vend value.

The user can also return the coin audit amounts to the factory default setting (zero). To reset all coin audit values, press "ENTER" when the "DEFAULT" prompt is shown. Press "ENTER" again when the "RESET" prompt is shown to confirm the action.

Cycle Count:

The cycle count field shows the accumulation of wash cycles that have occurred.

NOTE: that this is a count of cycles, not of hours accumulated.

The user can also set the count value to a designated number. For example, if it is necessary to replace the control on a machine, the new control could be programmed to show the cycle count value that was recorded by the previously installed control. The individual digits of the count can be set by using the "UP" or "DOWN" buttons to change the number that is flashing. Once the desired digit of the count is chosen, press the "ENTER" button to move to the next digit. Once the complete count is chosen, the "ENTER" button must be held down for 3 seconds to confirm the action.

The user can also return the cycle count to the factory default setting (zero). To reset the cycle count, press "ENTER" when the "DEFAULT" prompt is shown. Press "ENTER" again when the "RESET" prompt is shown to confirm the action.

Motor Hours:

The motor hours field shows the accumulated hours of operation for the motor. In many cases, it will match the cycle hours of the machine. However, separate fields are provided in the event that a motor is replaced on a machine.

The user can set the motor hours to a designated number. For example, if it is necessary to replace the control on a machine, the new control could be programmed to show the motor hours that were recorded by the previously installed control. The individual digits of the hours count can be set by using the "UP" or "DOWN" buttons to change the number that is flashing. Once the desired digit of the hours is chosen, press the "ENTER" button to move to the next digit. Once the complete hours are chosen, the "ENTER" button must be held down for 3 seconds to confirm the action.

The user can also return the motor hours to the factory default setting (zero). To reset the motor hours, press "ENTER" when the "DEFAULT" prompt is shown. Press "ENTER" again when the "RESET" prompt is shown to confirm the action.

Cycle Hours:

The cycle hours field shows the accumulated hours of operation for the washer. In many cases, it will match the motor hours of the machine. However, separate fields are provided in the event that a motor is replaced on a machine. See the Motor Hours description for more information.

Control Menu:

The Control menu allows for the user to observe important technical information for the control and Variable Frequency Drive system. No changes can be made at this menu. See below for detailed information on each sub menu.

Figure 11, shown below, shows the sub menu options for Control:

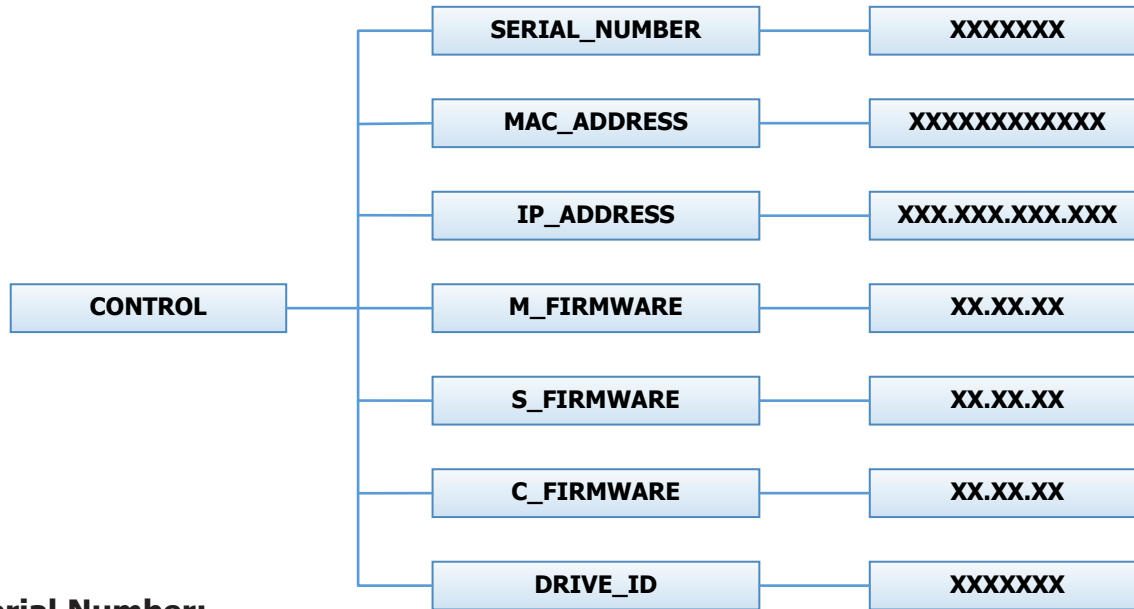

Serial Number:

The serial number is the control serial number.

MAC Address:

The MAC Address is a unique identifier designated to the control by the manufacturer. It allows the control to be recognized by network routers.

IP Address:

The IP Address is the identifier given to the control by a network system.

M Firmware:

The M Firmware is the Main Firmware currently loaded onto the control.

S Firmware:

The S Firmware is the Secondary Firmware currently loaded onto the control.

C Firmware:

The C Firmware is the Communications Firmware currently loaded onto the control.

Drive ID:

The Drive ID is the code that represents the size of the Variable Frequency Drive and parameters loaded into it, corresponding with the washer model.

USB Menu:

The USB menu allows for the user to move programming files back and forth from a common USB memory stick. Figure 12, shown below, shows the sub menu options for Control:

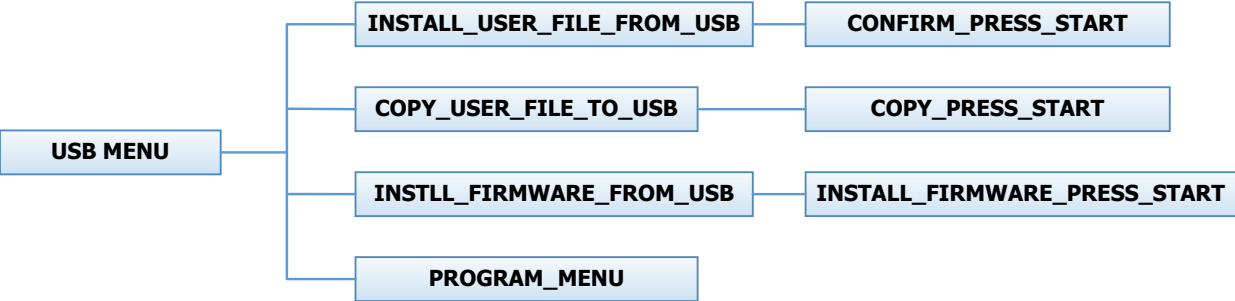

PROGRAMMING THE DRYER CONTROL

The dryer control can be programmed to prompt the user for alternate vend prices, change dryer cycle times, temperatures and many other options. This can be accomplished in two ways:

1. Manual programming utilizing the "Start", "High", "Medium" and "Low" buttons for the bottom dryer.
2. USB download of a customizable User File. For instructions on using the USB download feature, please contact your local Dexter distributor or visit DexterLive.com.

MANUAL PROGRAMMING:

The dryer must be in idle mode for the manual programming menus to be accessed. Idle mode is when the dryer is not actively running a drying cycle and the vend price is displayed on the screen

To enter the manual programming mode, the control tray on the dryer must be unlocked and pulled out to reveal the programming button. The programming button is then pressed for 1 second. The control should display "DRYER PROGRAMMING".

See the figure below for the location of the programming button on the control tray.

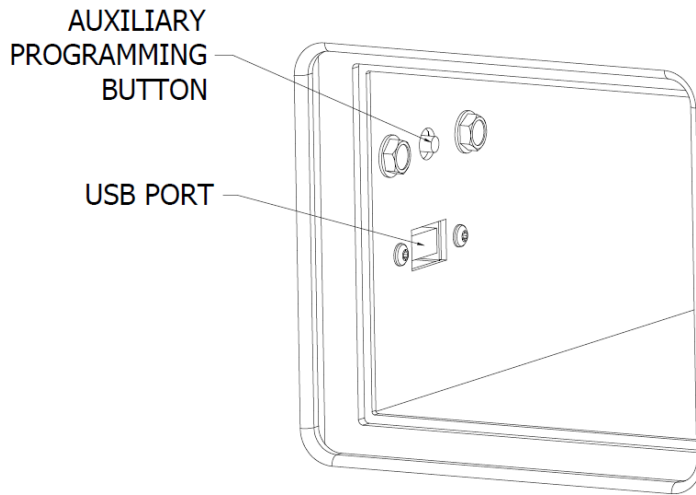

When manual programming mode is entered, the "START", "HIGH", "MEDIUM", and "LOW" buttons perform alternate functions.

Button Name	Alternate Function in Programming Mode
Start	Becomes the action to accept the displayed option or the "Enter" key
Hot	Becomes the action to move UP through displayed options (Press & hold for accelerated scrolling)
Warm	Becomes the action to move DOWN through displayed options (Press & hold for accelerated scrolling)
Cold	Becomes the action to move back a step (1 press) or EXIT from programming mode (press for 3 seconds)

These alternate functions allow the user to move through a menu of options to choose various programmable settings. The figure below shows the top level menu. Choosing an option from the top level menu will then display the next level of options (the sub menu).

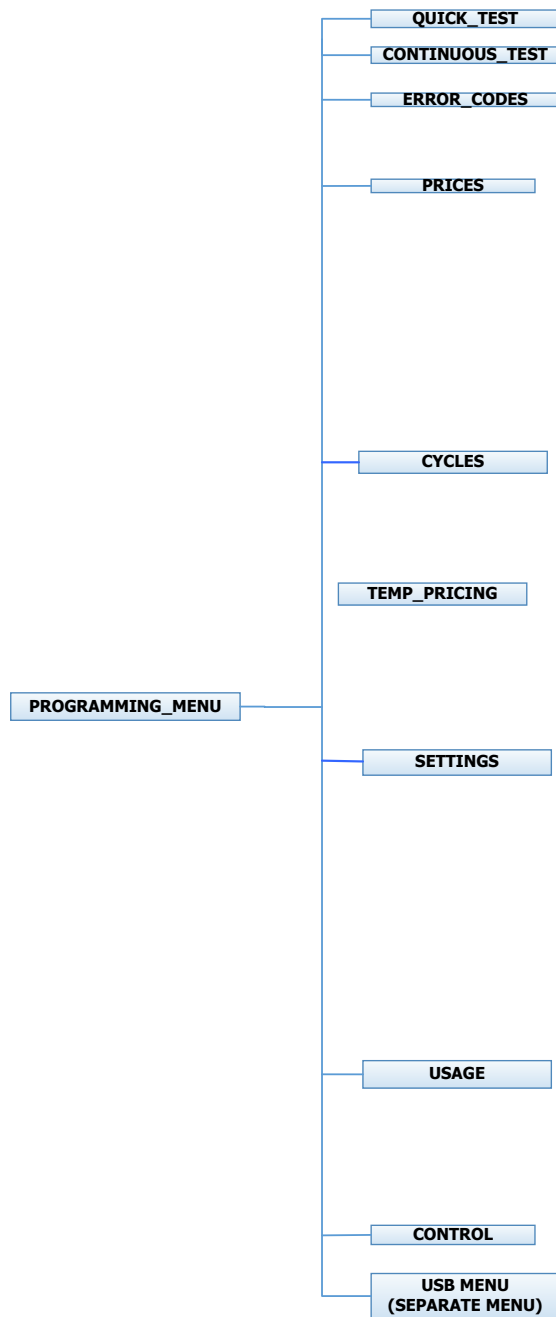

Quick Test Option:

When the Quick Test Option is chosen, the dryer will begin a shortened dry cycle without the displayed vend price being met. The purpose of this shortened cycle is to test all major components for proper operation. Error Codes should all function normally during this test. The display will show customer prompts in a similar way to a normal dry cycle.

Continuous Test Option:

Similar to the Quick Test, when the Continuous Test Option is chosen, the dryer will begin a dry cycle without the displayed vend price being met. However, in this case, it will be a continuously-running cycle. It will not time out after any designated amount of time.

CAUTION: This option is meant for factory use only. Do not operate the dryer with this cycle active without factory authorization.

Error Code Historical Log:

The last five occurring error codes will be stored in the control with a time and date stamp. The purpose of this option is only to observe the history of these code occurrences (no changes can be made).

The time is based off the Real Time Clock, but potentially shifted by the user's manual programming changes (Shift Hours option) and/or network time override. As additional error codes occur, the oldest of the five logged codes is cleared from memory.

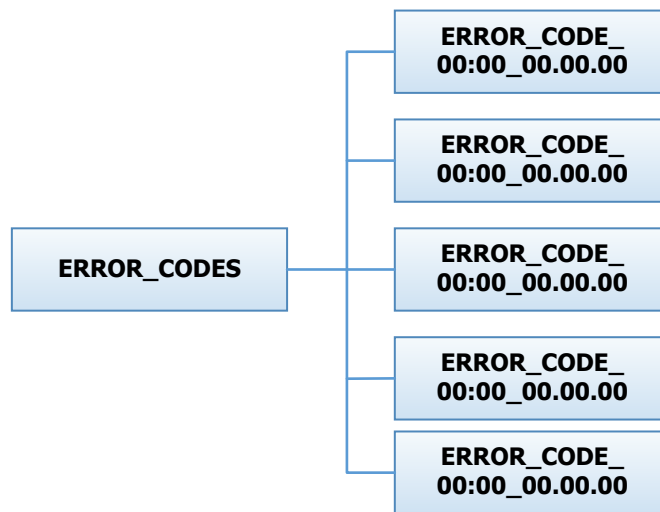

Prices Option:

This option allows the user to set values for coin acceptor inputs, vend price and time and extend dry price & time. It also allows the user to return the values to factory defaults. After changing prices using the "UP" or "DOWN" buttons, the "ENTER" button must be pressed again for the control to store the changes that have been made.

NOTE: that, in general, time values are set in 1 minute increments. This can be changed to 30 second increments, by changing the "DISPLAY TIME" to "MIN+SEC" (refer to the "Settings" section).

1. "RIGHT COIN" and "LEFT COIN" are the two possible inputs from coin acceptors.
2. "PRICE SET VEND" is the actual Base Vend Price (or Vend Price A) that is shown on the control display. The value can be increased or reduced even down to "0". In this case, the displays will prompt "FREE" and the cycle will start as soon as the "START" button is pressed (without any vend price being met).
3. "TIME SET VEND" is the cycle time that the customer has available once they've met the Base Vend Price.
4. "FREE SET TIME" is the cycle time that the customer has available if the Base Vend Price is set to "FREE".
5. "EXTEND DRY" sets the price and time for additional drying time that becomes available after the customer has already met the Base Vend Price.

To reset either the coin acceptor inputs or the vend price to factory default, press "ENTER" when the "DEFAULT" prompt is shown. Press "ENTER" again when the "RESET" prompt is shown to confirm the action.

Example- A store owner has programmed the control for the following values:

Base Vend Price	\$1.00
Base Vend Time	30 minutes
Extend Dry Price	\$.25
Extend Dry Time	8 minutes

In this case, the customer adds 4 quarters to satisfy the \$1.00 Vend Price. The display shows 30 minutes of drying time. At this point, if an additional quarter is added, the customer display shows an additional 8 minutes of drying time (38 minutes total) as per the Extend Dry Price & Time. The customer starts the drying cycle and at 25 minutes into the cycle (13 minutes displayed), they add an additional quarter. The controller adds 8 minutes to the displayed time again (21 minutes total) as per the Extend Dry Price & Time. "AFTER CYCLE" allows the user to choose whether a customer is allowed to add "EXTEND DRY" time for up to 30 seconds after the dryer door is opened after a completed cycle.

The figure below shows the sub menu options for Prices:

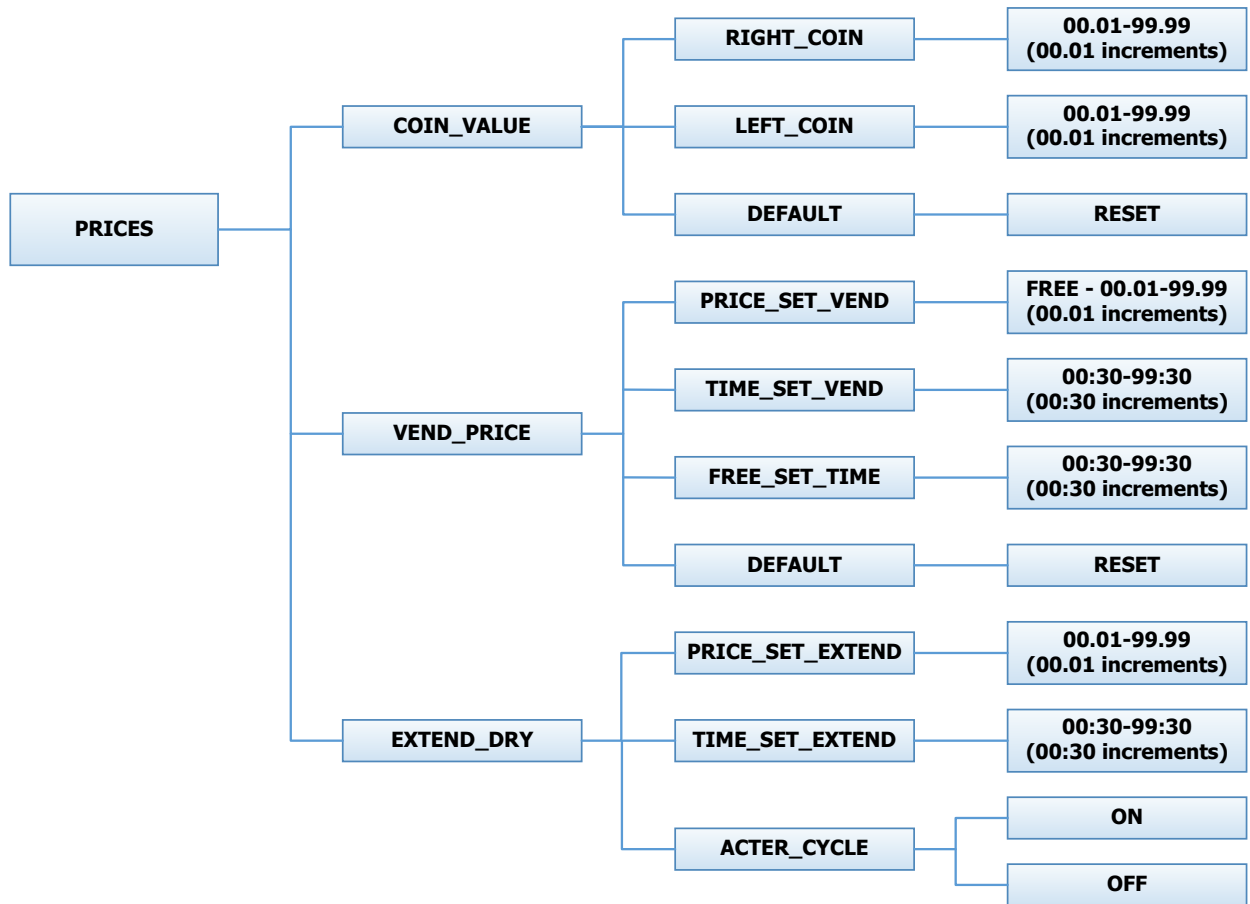

Cycles Option:

This option allows the user to set temperature and cooldown information for the drying cycle. It also allows the user to return the values to factory defaults.

1. "TEMP SETTINGS" allows the user to make adjustments, within a designated range, to the cycling temperature for each of the "LOW", "MEDIUM", and "HIGH" customer choices.
2. In addition, on the "LOW" setting, the user can reduce the cycling temperature below 110 degrees F. In this case, when the customer chooses the "LOW" setting, the dryer will not turn on the gas valve. When checked, the displayed temperature will read "NO HEAT".
3. "COOLDOWN" allows the user to change the designated time at the end of a cycle where the gas valve relay is turned off. On "HIGH" and "MEDIUM" temperature settings, the designated time cannot be reduced to less than 2 minutes.
4. "DEFAULT TEMP" allows the user to choose which general temperature setting, "HIGH", "MEDIUM", or "LOW", the control will default to at the beginning of each cycle if the customer does not make a choice.
5. "ANTIWRINKLE" is a feature that periodically rotates the dryers after a cycle is complete. If the door was closed at the end of the cycle, and is left closed for 5 minutes, the enunciator will sound and the display begins scrolling "ANTI WRINKLE". 5 seconds later, the dryer motor will turn on for 60 seconds and then turn off. The gas valves will not be turned on. The "ANTIWRINKLE" message will continue throughout the time that the motor is turned on. The user can choose to enable or disable this feature.

To reset all values in the Cycles option to factory default, press "ENTER" when the "DEFAULT" prompt is shown. Press "ENTER" again when the "RESET" prompt is shown to confirm the action.

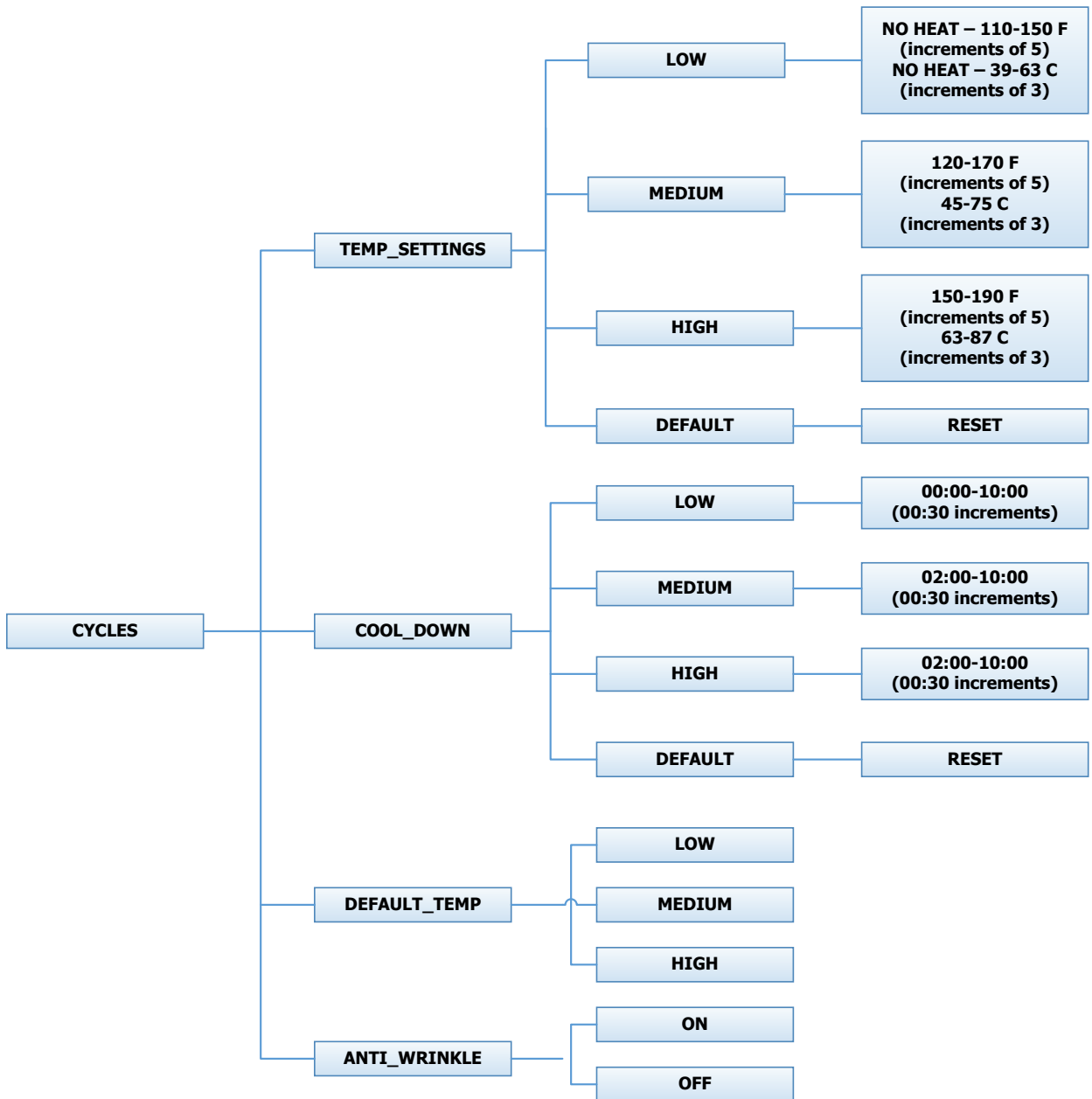

Temperature Pricing Option:

This option allows the user to require additional vend amounts be added based on the drying temperature chosen by the customer. This pricing adder is effective only for the Base Vend Price (it does not affect the Extend Dry Price). It allows a pricing adder separate for "MEDIUM" and "HOT" temperature settings.

Example- A store owner has programmed the control for the following:

Vend Price	\$1.00
Vend Time	30 minutes
Extend Dry Price	8 minutes
Medium Adder	\$.25
Hot Adder	\$.50

In this case, the Vend Price is displayed as:

\$1.00 if Low Temperature is chosen

\$1.25 if Medium Temperature is chosen

\$1.50 if Hot Temperature is chosen

When Temperature Pricing Adders are in place (user has chosen a higher value then \$0.00), if the customer attempts to change their temperature selection from a lower temperature to a higher one during a drying cycle, there will be no change in the temperature selection. The higher temperature buttons are disabled until the drying cycle is complete and a new Vend Price is required.

The figure below shows the sub menu options for Temperature Pricing:

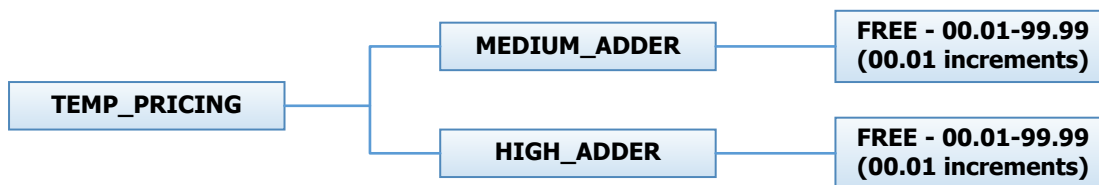

Settings Options:

The Settings options allow for the user to make various programming changes to change how the control operation affects the customer. See below for detailed information on each next level option.

1. "DECIMAL POINT": If the user programs the Decimal Point to "OFF", control display will not show a decimal point on any vend price values. The factory default is "ON".
2. "DISPLAY TIME": If the user programs this value to "MIN", then minutes only will be shown for the cycle time. If it is programmed to "MIN+SEC", then minutes and seconds will be shown. This also allows other programming changes, involving time to be made in either minute increments or minutes & seconds increments, as desired.
3. "TEMP SCALE": If the user programs this value to "F", then the temperatures will be displayed in Fahrenheit units. If it is programmed to "C", then the temperature will be in Celsius units.
4. "SOUNDS": If the user programs the Sounds to "OFF", the control will not sound the enunciator at the end of a dry cycle. The factory default is "ON".
5. "PASSWORD": If the user programs the password to any value other than 0000, the control will prompt the user to enter a password (the programmed value) before manual programming can be accessed. The factory default is "0000" (no password).
 - a. **NOTE:** that if the user forgets the Password, it can be reset to factory default (no password), by performing a hard reset on the control. Please refer to the appropriate section of this manual to understand how to perform a hard reset.
 - b. The individual digits of the Password can be set by using the "UP" or "DOWN" buttons to change the number that is flashing. Once the desired number is chosen for a single digit, press the "ENTER" button to move to the next one. Once all four desired digits are chosen, the "ENTER" button must be held down for 3 seconds to confirm that the complete password should be set.
6. "CENTRAL PAY": If the user programs this value to "ON", the left and right coin inputs become upper and lower dryer coin inputs.

Central Pay "OFF"	Central Pay "ON"
Left Coin Input	Upper Dryer Input
Right Coin Input	Lower Dryer Input

A system can then be installed that will register coin inputs per individual dryer remotely from a Central Pay kiosk. The left and right coin prices must be appropriately programmed. When this option is enabled, the controller will only display customer prompts for a designated dryer. This designated dryer is determined when coins are inserted at the Central Pay kiosk.

7. "LANGUAGE": The control uses English for the default language of the customer prompts. Alternatively, the user can choose Spanish, Maylay, Italian, or French for the customer display prompts. However, all other prompts, such as "MANUAL PROGRAMMING", "USB PROGRAMING" and any Error Codes will still display in English.

-
8. "SHIFT HOURS": This feature allows the user to shift the time used by the control from the time kept internally by the control. The control uses a Real Time Clock (RTC) to internally track the time and date. The RTC continues operation even if the control loses external power. The RTC is set for Central Standard Time and no daylight savings. Because the machine may be located in another time zone, the user can choose to create an alternate time & date that tracks in parallel to the RTC. When this alternate time is chosen, or shifted from the RTC, the alternate time will be used to, for example, track error code occurrences and set time-of-day pricing changes.
 - a. The hours in "SHIFT HOURS" can be set by using the "UP" or "DOWN" buttons to change the number that is flashing. Once the desired hour shift is chosen, press the "ENTER" button to move to the minutes. Once the hours and minute shift are both chosen, the "ENTER" button must be held down for 3 seconds to confirm that the complete shifted time is set.

 9. "TIME": The control uses a Real Time Clock (RTC) to internally track the time and date. The RTC continues operation even if the control loses external power. The RTC is set for Central Standard Time and no daylight savings. However, if a problem occurs and the RTC time is not accurate, it can be reset to the current time using this option.
 - a. The hours in "TIME" can be set by using the "UP" or "DOWN" buttons to change the number that is flashing. Once the desired hour is chosen, press the "ENTER" button to move to the minutes. Once the hours and minute are both chosen, the "ENTER" button must be held down for 3 seconds to confirm that RTC is meant to be reset to the complete entry.

 10. "DATE": Similar to "TIME", if a problem occurs and the RTC date is not accurate, it can be reset to the current date using this option.
 - a. The day of the month in "DATE" can be set by using the "UP" or "DOWN" buttons to change the number that is flashing. Once the desired day of the month is chosen, press the "ENTER" button to move to the month of the year. Once the desired month of the year is chosen, press the "ENTER" button to move to the year. Once the day, month, and year are all chosen, the "ENTER" button must be held down for 3 seconds to confirm that RTC is meant to be reset to the complete entry. To reset all values in the Settings options to factory default, press "ENTER" when the "DEFAULT" prompt is shown. Press "ENTER" again when the "RESET" prompt is shown to confirm the action.

The figure below shows the sub menu options for Settings:

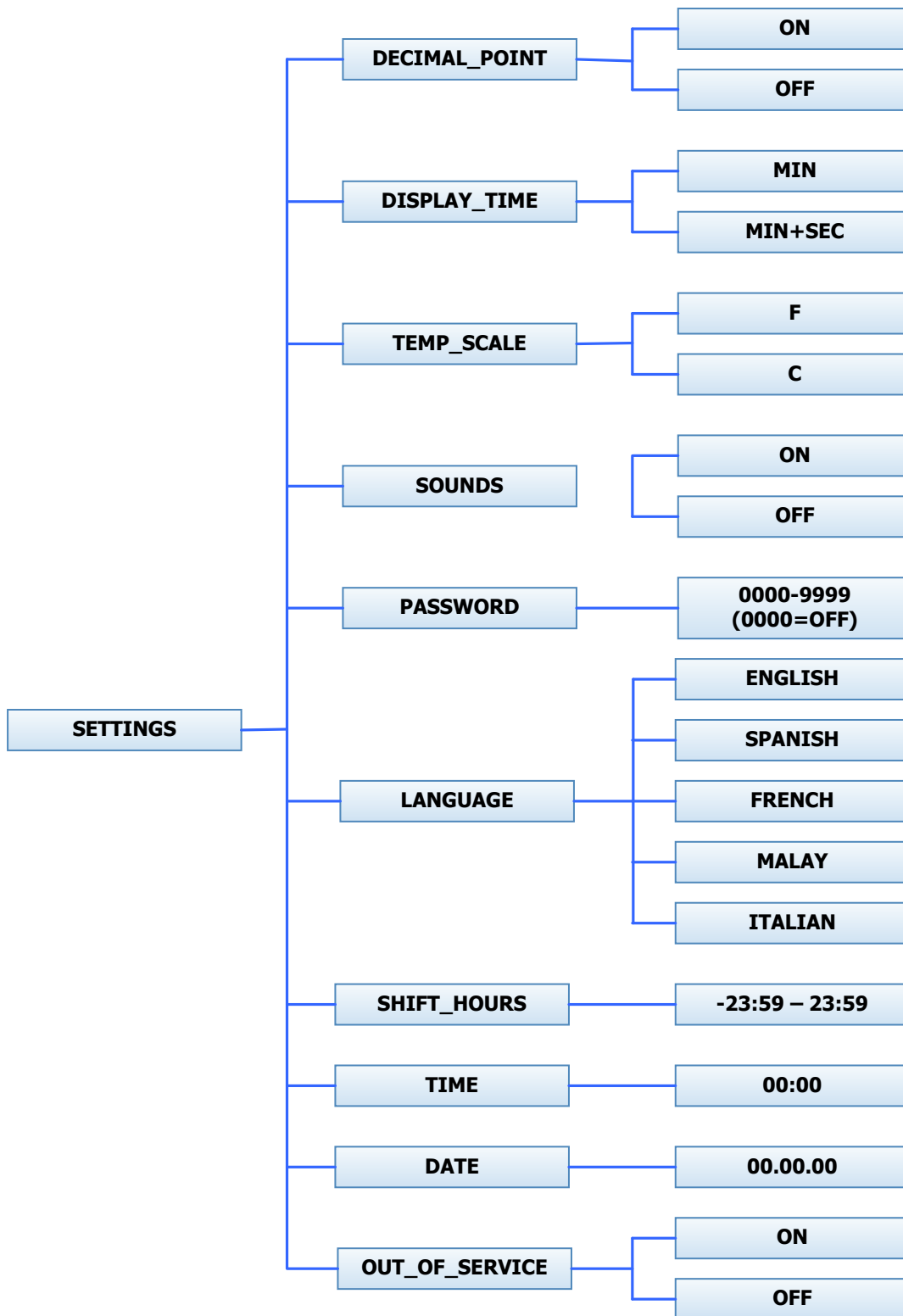

Usage Menu:

The Usage menu allows for the user to track data about machine usage. See below for detailed information on each sub menu option.

1. "COIN AUDIT": The coin audit field shows the accumulation of coin pulses that were sent to the control over each of the left and right coin inputs.

NOTE: that this is a count of coin pulses, not an accumulated report of vend value.

 - a. The user can also return the coin audit amounts to the factory default setting (zero). To reset all coin audit values, press "ENTER" when the "DEFAULT" prompt is shown. Press "ENTER" again when the "RESET" prompt is shown to confirm the action.

2. "MOTOR HOURS": The motor hours field shows the accumulated hours of operation. In many cases, it will match the cycle hours of the machine. However, separate fields are provided in the event that a motor is replaced on a machine. The user can set the motor hours to a designated number. For example, if it is necessary to replace the control on a machine, the new control could be programmed to show the motor hours that were recorded by the previously installed control. The individual digits of the hours count can be set by using the "Up" or "Down" buttons to change the number that is flashing. Once the desired digit of the hours is chosen, press the "Enter" button to move to the next digit. Once the complete hours are chosen, the "Enter" button must be held down for 3 seconds to confirm the action.
 - a. The user can also return the motor hours to the factory default setting (zero). To reset the motor hours, press "ENTER" when the "DEFAULT" prompt is shown. Press "ENTER" again when the "RESET" prompt is shown to confirm the action.

3. "CYCLE HOURS": The cycle hours field shows the accumulated hours of operation. In many cases, it will match the motor hours of the machine. However, separate fields are provided in the event that a motor is replaced on a machine. See the Motor Hours description for more information.

The figure below shows the sub menu options for Usage:

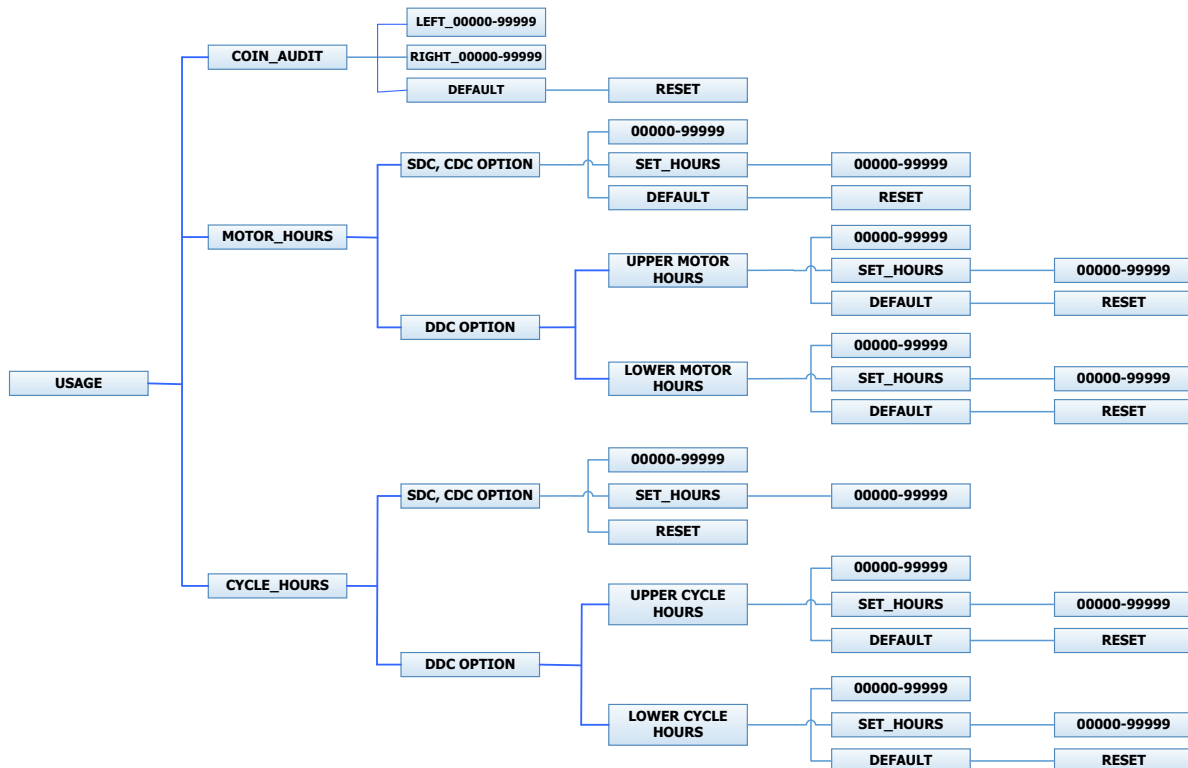

Control Menu:

The Control menu allows for the user to observe important technical information for the control. No changes can be made at this menu. See below for detailed information on each sub menu.

1. "SERIAL NUMBER": This is the control serial number.
2. "MAC ADDRESS": The MAC Address is a unique identifier designated to the control by the manufacturer. It allows the control to be recognized by network routers.
3. "IP ADDRESS": The IP Address is the identifier given to the control by a network system.
4. "M FIRMWARE": The M Firmware is the Main Firmware currently loaded onto the control.
5. "C FIRMWARE": The C Firmware is the Communications Firmware currently loaded onto the control.

The figure below shows the sub menu options for Control:

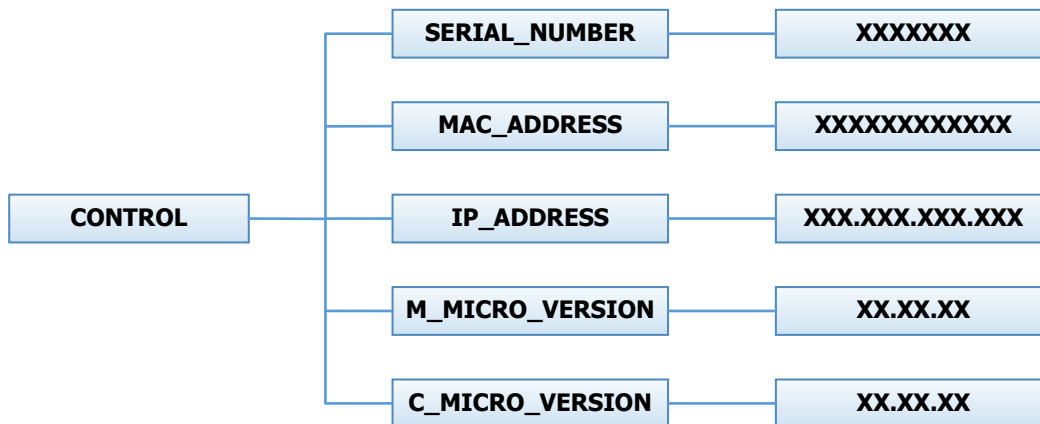

USB Menu:

The USB menu allows for the user to move programming files back and forth from a common USB memory stick.

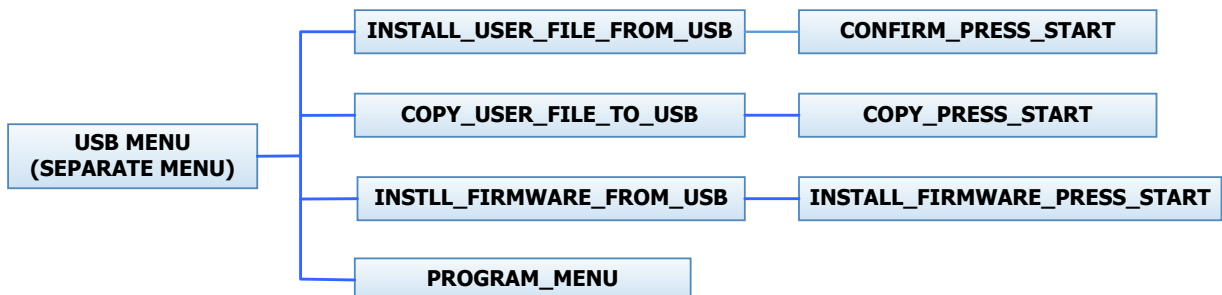

2.11.5 MAXIMUM SPIN SPEED ADJUSTMENT (All washers except T-950)

If desired, the washer can be adjusted to limit the maximum extract spin speed for all wash cycles.

To make this adjustment, a jumper wire must either be installed or removed on the Variable Frequency Drive (VFD), depending on the washer model and desired speed. This Dexter jumper part number 8220-057-036 (qty 1) is factory supplied on terminal points "10V" and "RC". Remove this jumper to make new jumper connections if necessary. Refer to figure below for the approximate location of the control terminations on the Variable Frequency Drive (VFD) and for appropriate jumper connection points indicated with an "X" for the desired maximum spin speed setting. If no adjustment to the default spin speed is desired, do not remove or add any wires on VFD.

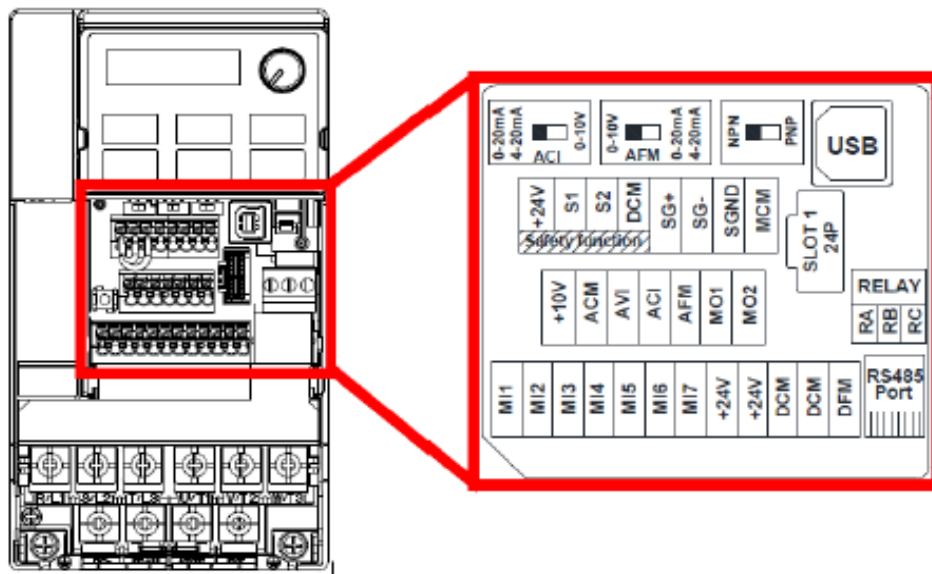

Control Terminations on Variable Frequency Drive

V Series Washer Model	Max Spin Speed	Jumper Terminal Locations on Variable Frequency Drive (VFD)													
		MI1	MI2	MI3	MI4	MI5	MI6	DCM (Left)	DCM (Right)	24V	ACM	AVI	ACI	10V	M01
T-300, T-400, T-600, T-900, T-1200	60 G											X		X	
	80 G				X			X							
	100 G	Default Setting (No Jumper Required)													
T-350, T-450, T-750	60 G											X		X	
	100 G				X			X							
	140 G					X		X							
	200 G	Default Setting (No Jumper Required)													
T-650, T-1450	100 G											X		X	
	140 G	REMOVE Brown Jumper Between MI5/M01													
	200 G	Default Setting (No Jumper Required)													

Spin Speed Adjustment Jumper Locations

MAXIMUM SPIN SPEED ADJUSTMENT (T-950 Only)

The variable frequency drive allows for varying acceleration during Final Spin on T-950 models. It is important to utilize a decreased acceleration rate when the application power is low. This acceleration rate is determined by a white wire jumper installed on the drive terminal block from +10V to AVI.

Remove the wire jumper when input power is between 208 and 219 volts. Keep the jumper installed when input power is between 220 and 240 volts. Reference the drawing below for the jumper location.

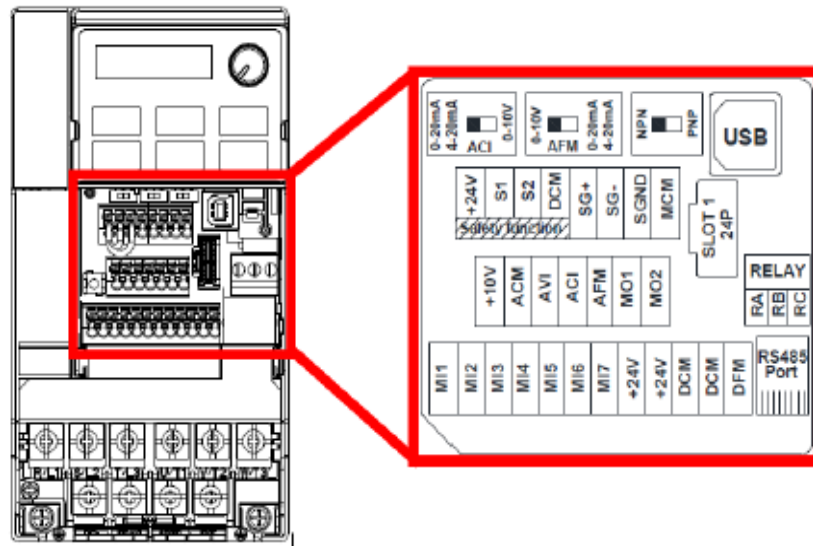

Control Terminations on Variable Frequency Drive

V Series Washer Model	Input Voltage	Max Spin Speed	Jumper Terminal Locations on Variable Frequency Drive (VFD)													
			MI1	MI2	MI3	MI4	MI5	MI6	DCM (Left)	DCM (Right)	24V	ACM	AVI	ACI	10V	M01
T-950	240V	140 G	REMOVE Brown Jumper Between MI5/M01													
		200G												X		X
	208V	140 G	REMOVE Brown Jumper Between MI5/M01													
		200G	No Jumper required													

T-950 Spin Speed Adjustment Jumper Locations

Section 4:

Dryer Service,
Trouble Shooting
and Schematics

Service Procedures

Clothes Door Removal

1. The clothes door may be removed from the hinge bracket by unscrewing and removing the allen-head pivot screw located at the door upper hinge point.
2. Next lean the door out of the top of the hinge bracket and lift the door from the bottom hinge pin.

NOTE: the spacer between the bottom of the door and the hinge.

Clothes Door Latch Adjustment

1. Loosen the lock nut on the latching stud. It is located directly behind the door handle.
2. Open the loading door.
3. Screw the door catch stud in or out as necessary and then retighten the lock nut.

Door Switch Removal And Installation

1. Each door switch is located directly behind the hinge plate of the loading door assembly.
2. The entire switch can now be pulled from the front panel opening.
3. The switch has two clips that hold it in place on the rear of the switch.
4. With the panel removed, you can now squeeze the two clips and allow switch to be pushed back through panel and grasped from the front and switch removed.

Installation Of Clothes Door Window And Gasket

1. Place the clothes door, with its face down, on a solid surface.

NOTE: Prewarming the gasket makes the installation much easier.

2. Install the window gasket on the clothes door flange. The wider lip of the gasket should be on the bottom side or front face of the clothes door and the ridges should be up.
3. Locate the seam at the latching stud.
4. Apply a soapy water solution or rubber lubricant to the gasket.
5. Slide the glass into the middle of the door ring and gasket with half of the glass above the door and half below.
6. While pressing down on the glass, stand the door up and use a modified screw driver with the end rounded off to install half of the glass. Lay the door down and install the other half.
7. At the six o'clock position, pry the glass up enough to install the black spacer. (reuse from old door gasket)

High Limit Thermostat Location And Function

A. Burner Housing- This hi-limit is located on the back side of the burner housing.

1. The thermostat opens the circuit to the main burners in the event of malfunction in the gas control area or temperature control. This thermostat will open quickly if there is a significant loss of air flow over the burner area.
2. It is covered by a guard and is held in place by two screws. There are spacers between the thermostat and bracket which must be used to give proper operation.

-
- B. Manual Reset Over temperature Safety Thermostat-** The second hi-limit thermostat is located on the right side of the burner housing as you view from the back of the machine. It is just above the gas valve and covered by a guard with a small access hole.
1. The manually resettable thermostat limits the operating temperature a dryer can reach should some abnormal situation occur.
 2. Should the thermostat be tripped, the tumbler will cease to heat until the thermostat is reset. Once the dryer cools, the thermostat may be reset by inserting a pencil or stick through the opening in the thermostat cover.

REMOVAL: To remove either the hi-limit thermostat on the rear of the burner housing or the over-temperature thermostat on the right side of the burner housing, remove the mounting screws holding its respective guard. Next, remove the terminal of each wires attached to the thermostat. Lastly, remove the mounting screws holding the thermostat to the burner.

Pressure Regulator Adjustment

Use the following procedure whenever it is necessary to check the pressure regulator setting.

NOTE: Any adjustment of the pressure regulator must be made with a manometer attached at the plug in the main burner manifold.

1. Shut off the gas supply to the dryer.
2. Remove the 1/8" pipe plug from the end of the main burner manifold.
3. Attach a manometer to the manifold end.
4. Remove the pressure regulator cover screw on the gas valve.
5. Open the shutoff valve, and operate the dryer.
6. Adjust the pressure for a manometer reading of 3.5" water column gas pressure. (11.0" for L.P.)

NOTE: The main burners must be operating when adjusting the pressure regulator.

7. Shut off the gas supply to the dryer. Remove the manometer and install the 1/8" pipe plug in the manifold.
8. Open the shut off valve, start the dryer, and check for gas leaks while the burners are ignited.

Heat Sensor

This unit takes the place of the regulating thermostat on a mechanical timer dryer. The Heat Sensor is a thermistor. The way these work is fairly simple. As the temperature goes up, the resistance in the thermistor (heat sensor) goes down. As the temperature drops, the resistance in the thermistor (heat sensor) goes up.

Electronic Control Removal

Unlock the retaining lock in the control assembly. Slide the control out of the machine holding the control by the metal tray. There is enough wire length to allow removing the control tray from the machine before disconnecting the wires.

Temperature Sensor Testing

If either tumbler display shows an "Temp Sensor Short" or "Temp Sensor Open", that is an indication of possible temperature sensor problems for that tumbler. Before replacing a sensor, check the wires and connections of the sensor for damage. The sensor lead wires are very small and care should be used in routing and connecting them. The sensors are located under the tumblers and may be viewed by removing the lint screen. The temperature sensor should have 40,000 ohms resistance at room temperature if okay.

Temperature Testing

To check the temperature in the dryer tumbler, press and hold the start button and while holding the start button also press the temperature button for the temperature to be checked. The display will read out the current temperature.

30Lb Stack Washer/Dryer Temperature Sensor Removal

First remove Electronic Control. Once the Control is removed, disconnect Temp Sensor wires by removing the two gray wire nuts. Remove the two temp sensor mounting screws, 5/16 head, remove Temp Sensor bracket assy. Remove sensor from bracket and replace and reinstall in reverse operation.

30Lb Stack Washer/Dryer Front Panel Removal

The loading door does not have to be removed to remove the front panels on this model.

1. Remove the left two screws with finish washers.
2. Remove the right two screws with finish washers, at this time the front panel is loose but connected by the harness to the door switch.

NOTE: Always remove power from the machine before changing drive belts or working with the drive system.

Final Drive/Motor Belt Replacement

To replace the final drive belt turn the cylinder slowly by hand and work the belt off of the large pulley.

NOTE: All drive belts are self adjusting.

Tumbler Pulley Removal And Installation

Remove the 1/2" nut and lock washer. Pull the pulley off the shaft. Upon installation, the tumbler bolt should be torqued to 75 ft./lbs.

1. on the set screws and torque to 165 in/lbs.
2. The Motor is mounted with 4 bolts to the motor mounting bracket on the rear of the dryer.
3. Reassemble in reverse order.

Air Flow Switch Operation And Adjustment

The air flow switch assembly is part of the ignition safety circuit and insures that the burners don't operate unless there is air flow. When the drive motor and blower are running the flat actuator is pulled in against the back of the dryer closing the switch. If this doesn't happen ignition will not occur. The air flow switch assembly is mounted by two screws through the bracket. It can be adjusted by loosening these mounting screws and moving the switch forward or backward.



Ignition Transformer Fuse

The 1.5 amp fuse protects the ignition transformer. To remove it just twist and pull it out.

Electronic Ignition Module

This machine uses an electronic spark ignition system to directly light the burners.

1. The electronic ignition module is located inside the electrical box. This is the metal box on the back of the tumbler area directly to the left of the final drive pulley.
2. The red wire from the transformer traveling thru the 1.5 amp fuse and into the module supplies the 24VAC required to operate the entire direct ignition system.
3. The black colored hi-voltage wire (spark plug type) plugs onto the post connector on the module, and the multi-wire plug fits into the side of the module.

Spark Ignition Module Removal

Without mounting bracket

Remove all of the terminals of the wiring harness attached to the ignition module. Then, remove the terminal of the hi-voltage cable attached to the ignition module. Lastly, remove the mounting screws holding the ignition module in the control box. If there is no spark or intermittent spark, check black hi-voltage lead wire for damage

NOTE: Proper grounding of the ignition system (yellow wires) is very critical for proper ignition sequence.

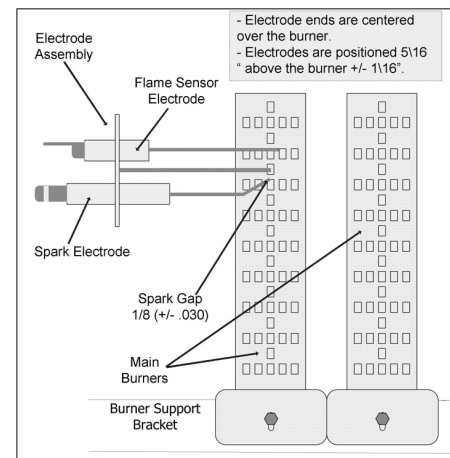

Ignition System-Function & Sequence

During normal dryer operation, the following occurs:

1. The dryer electronic control calls for heat.
2. If the drive motor is running, the blower motor safety circuit provides power to the electronic control. If the control senses that the heat should be on, a circuit is closed allowing power through the high limit thermostat, air flow switch.
3. Once the flame is established, the sensing electrode detects the presence of flame and the sparking stops.
4. If for any reason the flame is not established in a period of 10 seconds, the electronic control will try this sequence for 3 tries. Normally the 10 seconds "Trial For Ignition" period is ample to establish and prove flame.
5. If the flame is shutdown or blown out during operation, the ignitor will immediately go into "Trial For Ignition" again for 10 seconds.
6. However, at the end of 3 separate retries of 10 seconds "Trial for Ignition", the flame is not established, the ignition system goes into "Safety Lock-Out" and will not reactivate the "Trial for Ignition" until there is a current interruption for a period of 15 seconds. This interruption can be provided by opening the dryer loading door and allowing the machine to come to a complete stop for 15 seconds.

Ignition System-Checkout

1. If flame is present during "Trial For Ignition" period but the system shuts down, there may be an improper ground. The entire ignition system is grounded together including the electrode assembly, the electrode mounting bracket, the burners and the burner bracket. Shutdown can also occur if for some reason the system isn't sensing the flame. Check the sensor for damage and check the connections of the sensor lead.
2. If there is no spark or intermittent spark, check black hi-voltage lead wire for damage or cracks in insulation. (This lead wire must not be taped or connected to any metal edges along its length to prevent pinching and arcing. Also, do not bundle this wire with other wires.)

NOTE: Spark gap and electrode location are important. If the electrode is damaged or mounting is changed the spark gap may not be correct for ignition to occur. Check for cracks in the ceramic insulator. Replace electrode assembly if necessary. Also check for carbon or foreign material on the electrodes and clean if necessary.

Spark Electrode Assembly-Removal

1. Remove electrode cover and disconnect wires to electrodes.
2. Remove two screws to detach electrode assembly.

Gas Valve Removal (shut off manual gas valve to stop gas flow before removing gas control valve)

1. Disconnect union at gas valve and disconnect wires from gas valve operator coils.
2. Remove right manifold mounting bracket screws and slide manifold to remove from left bracket.

Main Burner Orifice Removal

1. Remove manifold and gas valve assembly as above.
2. Using an open end wrench, remove orifices from manifold.

Main Burner Removal

Remove the 4 screws securing the cover for the burner housing and the one screw mounting the high limit cover. With the burner housing cover removed, there is complete access to the burner assemblies.

Recirculation Chamber Inspection

Remove Resettable manual overtemp sensor and remove inspection plate in burner chamber between main burners and rear back panel of dryer.

Cylinder Removal

1. Remove the front panel in front of the cylinder.
2. Remove drive belt, pulley.
3. Pull the cylinder from the front of the machine.

Adjustment Of Cylinder Assembly With Front Panel Removed

1. Loosen the two top adjusting bolts and two bottom adjusting nuts and lock nuts holding the bearing housing to the drive plate.
2. Loosen the four mounting bolts on the side channels.
3. Open the clothes door and insert a 1/4" thick shim at the 3 and 9 o'clock positions and a 1/8" thick shim at the 6 o'clock position.
4. Tighten the two bottom adjusting nuts and tighten locking nuts.
5. Tighten the bottom right mounting bolt, then the top left mounting bolt. Tighten the remaining two bolts. (Shim where and if necessary.)
6. Tighten the two top adjusting bolts.
7. Remove all the shims from between the front panel flange and cylinder (3, 6, and 9 o'clock).
8. Spin the cylinder to check for rubbing baffles, pressing down hard while rotating. If rubbing is detected, repeat procedure paying particular attention to placement of shims between bearing housing and side channels.

Tumbler Through Bolt Access Cover

Remove 4 screws that mount the air flow switch to the back of the dryer. Remove 2 screws that retain access cover. With access cover removed, tightness on the tumbler through bolts can be checked and tumbler alignment can be adjusted.

Bearing Housing Removal

After removing cylinder as previously outlined, simply unbolt the bearing housing and remove.

Trouble Shooting Dryer

Electronic Control Diagnostic Lights

The electronic control has 3 diagnostic lights to aid in service of the dryer. The Dryer has indicator lights for the motor circuit, door switch circuit, and the heat circuit. When the electronic control is carefully unlocked and moved forward these lights are visible on the circuit board. They are each labeled as to function indicated.

1. When dryer door is closed, the appropriate door light on the computer should be illuminated indicating that the door is closed.
2. When dryer is running, the appropriate motor light on the computer should be illuminated indicating that the computer is calling for the motor to operate.
3. When dryer is calling for heat, the appropriate heat light on the computer should be illuminated indicating that the computer is calling for heat.

An example of their function would be troubleshooting the dryer pocket that did not heat.

1. Start the machine and insure that it did not heat.
2. Check the upper heat light and see if it is lit.
3. If the heat light is on, this would indicate that the computer was calling for heat and that it was not at fault. You would then go on to check the rest of the heat circuit.

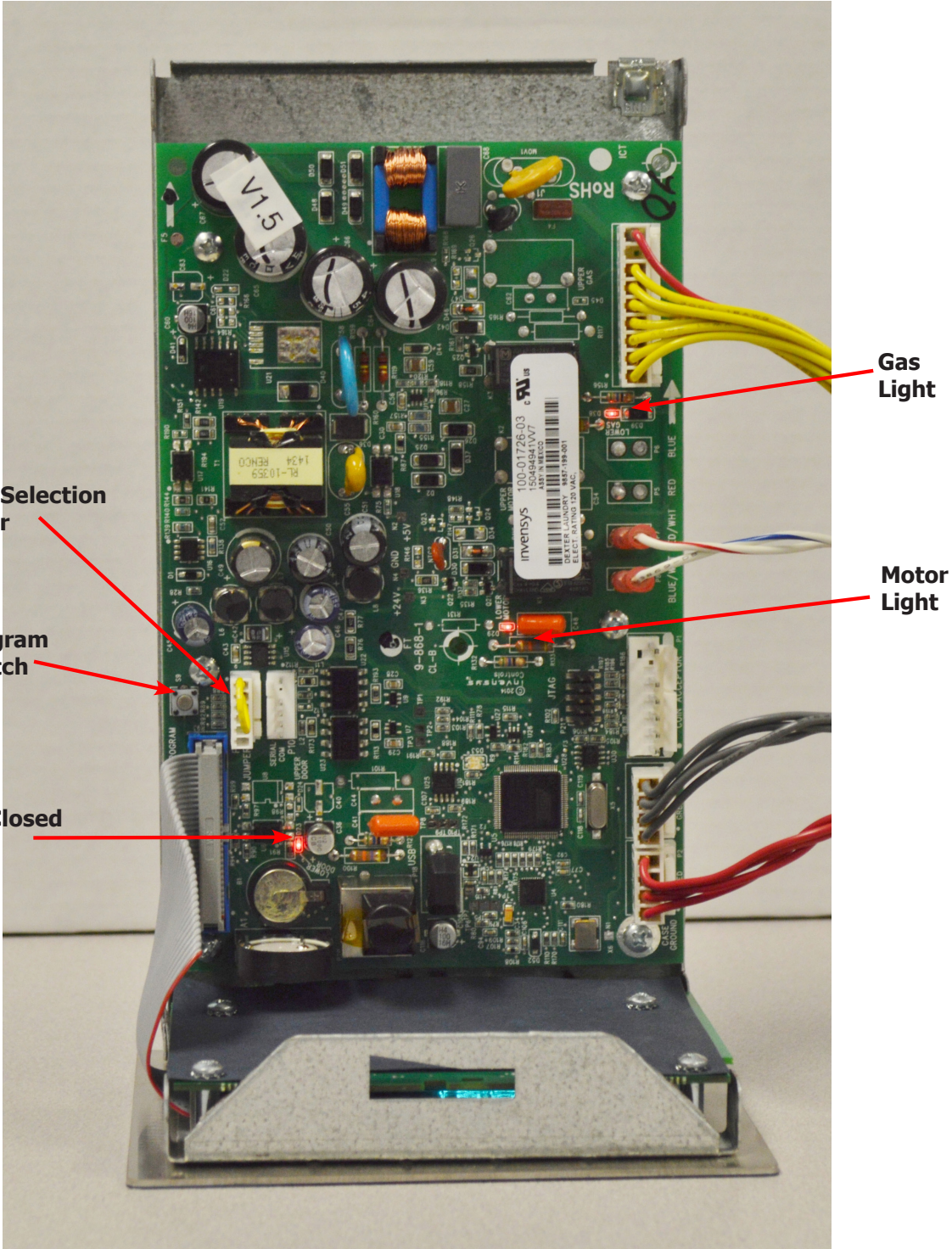

Model Selection Jumper

Program Switch

Door Closed Light

Gas Light

Motor Light

Figure: 1

To enter a test Cycle Mode you will have to enter the programming mode:

MANUAL PROGRAMMING:

The dryer must be in idle mode for the manual programming menu to be accessed. Idle mode is when the dryer is not actively running a drying cycle and the vend price is displayed on the screen.

To enter the manual programming mode, the control tray on the dryer must be unlocked and pulled out to reveal the programming button. The programming button is then pressed for 1 second. The control should display "DRYER PROGRAMMING".

See Figure 1

Next press START and you can scroll through the options you will either want to select Quick test or Continuous Test depending on the length of time you require to preform the tests.

Quick Test Option:

When the Quick Test Option is chosen, the dryer will begin a shortened dry cycle without the displayed vend price being met. The purpose of this shortened cycle is to test all major components for proper operation. Error Codes should all function normally during this test. The display will show customer prompts in a similar way to a normal dry cycle.

Continuous Test Option:

Similar to the Quick Test, when the Continuous Test Option is chosen, the dryer will begin a dry cycle without the displayed vend price being met. However, in this case, it will be a continuously-running cycle. It will not time out after any designated amount of time.

CAUTION: This option is meant for factory use only. Do not operate the dryer with this cycle active without factory authorization.

Error Codes

Symptom	Probable Cause	Suggested Remedy
TEMP SENSOR SHORT	Shorted Temperature Sensor Or Wire.	The dryer control shall not start until the detected short circuit is removed. Regardless of condition of short circuit, Error Code will be displayed until programming button is pressed to return machine to idle mode.
TEMP SENSOR OPEN	Open Temperature Sensor Or Wire	The dryer control shall not start until the detected short circuit is removed. Regardless of condition of short circuit, Error Code will be displayed until programming button is pressed to return machine to idle mode.
PCB ERROR1	Memory Corrupted	Power machine down and try to reset control. Varify voltage to the control board. Check ground to board. Replace control board if error can not be cleared

Error Codes

Symptom	Probable Cause	Suggested Remedy
PCB ERROR2	Analog / Digital Error	Power machine down and try to reset control. Vary voltage to the control board. Check ground to board. Replace control board if error can not be cleared
COMM ERROR1	Communication Bus Error	Power machine down and try to reset control. Vary voltage to the control board. Check ground to board. Replace control board if error can not be cleared
COMM ERROR2	No Dryer Model Selected	This error occurs when a pin combination on the model selection header is used that does not have a model designated for it. check connector marked Jumpers on the control board.
COMM ERROR7	Communication Bus Error	If a state-of-health message reply is not seen by the master microprocessor from the UC3 microprocessor after 10 minutes, the master will reset the UC3 and restart the 10 minute timer. Again, after 10 minutes, if a state-of-health message is not received by the master, it will reset the UC3 a second time. After 10 minutes, the master will reset the UC3 a final time and post a COMM ERROR 7. Note: When the master resets the UC3, the control will disconnect from the network. If the first reset is not successful, the control will not be able to reconnect to the network, USB or card reader functions.
FUSE ERROR	Programming Error	This error occurs when the fuse settings have not been set correctly during factory programming, Replace Control
CRC ERROR	Firmware Corrupted	This error occurs the dryer control firmware fails a CRC check. Replace Control

TROUBLESHOOTING

Symptom	Probable Cause	Suggested Remedy
Tumbler does not turn	Drive Belts	Check both drive belts. Replace if failed.
	Drive Motor	Check capacitor and motor. Replace if failed
	Door Switch	Check for door closed L.E.D on control board. Check door switch contacts and adjustment. Adjust or replace door switch.
	Electronic Control	Is electronic control closing motor relay to power drive motor? Check for motor light on electronic control. If no light and time counting down, change control. If light is on, check for proper voltage and wiring to motor relay in rear control compartment.
	Motor Run Relay	Test for proper voltage to run relay coil, test output voltage of relay when contacts engaged, if no voltage replace relay.

Symptom	Probable Cause	Suggested Remedy
Tumbler turns but no spark at burner	Glass Fuse	Check small glass control fuse in back of dryer. Replace if failed.
	Temperature Sensor	The temperature sensor should have between 40,000 ohms resistance at room temperature if okay. Replace if not in this range.
	Ignition	Check for 24VAC output from transformer.
	Over-Temperature	Check to see if manually resettable thermostat. Thermostat is kicked out. Reset by pushing red reset button.
	Ignition Control	Check for 24VAC coming into the control on the at burner red wire. If voltage, then check for 24VAC out on the brown wire. Also check for spark at the ignitor. If no 24VAC output or no spark to the ignitor, replace ignition control.
	Air Flow Switch	Check air flow switch to be sure it closes when dryer is running. If not, adjust or replace switch.
	Hi-limit	Check for continuity. Should be 0 ohms resistance when cold. If not, replace thermostat.
	Gas Supply	No gas can cause system lockout
	Electronic Control	Is electronic control closing gas relay to power Control heat circuit? Check for gas light on electronic control. If no light change control. If light is on, check voltage and components in heat circuit at transformer at rear of unit.

60HZ Wiring Schematic Dryer Idle - No Coins Added

Top Dryer Used For This Example

110 VAC 60Hz is supplied to the main power terminal block, L1 power, N=neutral, plus ground. BLK/Red coming off of L1 and BLK/BLU coming from N power the R1, and R2 motor relays. Red wire from L1 and the blue wire from N supply power and neutral to the step down transformer. After the stepdown transformer the control is protected by a 2.5 Amp fuse in the black wire. When there is power to the dryer the Computer Board will be powered and the display lighted from the 24 VAC secondary side of Control Step Down Transformer. 24 VAC from here is also on one side of the door switch on a black wire. Closing the loading door allows 24 VAC to pass on to the Computer Board on two blue wires. One blue wire makes 24 VAC available to one side of the Motor Run Relay on Computer Board. The other blue wire provides a 24 VAC signal to the Computer Board telling it that the door is closed and door light on the computer board should be illuminated.

Coins Added - Motor Starting and Running

Top Dryer Used For This Example

As each coin is added the Coin Switch closes and completes a circuit to the Computer Board. The Computer Board counts these signals and registers them against time. The time will display once the Start Button for Upper or Lower is pushed. When the Start Button is pushed again the Computer Board Motor Run Relay closes on the computer. With this Relay closed, 24 VAC is supplied to the Motor Control Relay (R1) on the red wire and also a violet wire going down to motor. The motor LED on the computer board should be illuminated anytime the computer calls for the motor to operate. With (R1) engaged and 110 VAC at motor the Motor Start Switch in motor is drawn in to the start position. In this position the incoming power 110 VAC is supplied directly to the main run winding and through the Start Capacitor to the Auxiliary Winding (start winding). As the Motor comes up to speed, the centrifical switch inside motor opens the circuit to the Start Winding and closes the circuit to allow 24 VAC to pass to the Gas Relay on the Computer Board on the other violet wire. The heat circuit in the dryer can not operate if the motor is not running. The gas LED on the computer board will be illuminated when Computer Board calls for the heat after Motor Centrifical Switch has closed.

Heat Circuit

Top Dryer Used For This Example

With the Drive Motor running and 24 VAC provided to the Computer Board Gas Relay, it will close if Computer Board senses programmed temperature is needed. The violet wire changes to an orange wire out of the Computer Board Gas Relay. When this relay closes it provides 24 VAC to the High Limit Thermostat. The High Limit Thermostat is normally closed. (It will open, turning off the heat circuit, if the dryer can't move enough air from problems such as an exhaust restriction or other problems.) 24 VAC now goes through to the normally open Air Switch (Sail Switch) on the brown wire. This switch is closed only if the dryer is running and has the correct air flow. With the dryer running and the Air Switch closed, 24 VAC is supplied to the normally closed upper manual reset Overtemp Thermostat on the gray wire and changes to the black wire out of switch and then changes to red wire and goes to the 1.5 amp in-line fuse that protects the Upper Ignition Controller(GREY BOX). With 24 VAC now supplied to the Upper Ignition Controller (GREY BOX) it will then send high voltage to the Spark Ignition Electrode via the High Voltage Lead Wire (this lead looks like an automotive spark plug wire). The Ignition Control Module (GREY BOX) simultaneously sends 24VAC to the Gas Valve Coil which open the Gas Valve and allows gas to pass through to the main burner. When ignition occurs the high voltage sparking stops and if Ignition Control Module (GREY BOX) gets a flame sense signal it will allow gas valve coil to remain energized and continue burner operation. If ignition does not occur, the Ignition Control Module (GREY BOX) will spark for 10 seconds before locking out.

Manual Reset Safety Shutoff Over-Temperature Thermostat

Top Dryer Used For This Example

This thermostat is manually reset by pushing in the red button. The Over Temperature Thermostat is a safety backup for the entire Heat Circuit and located in the recirculation chamber area on the side of the burner housing. If the dryer over heats this Over Temperature Thermostat it opens the line to turn off the heat but leaves the Computer Board lighted and the drive motor powered and turning so the basket will cool down.

Cool Down

Top Dryer Used For This Example

At the preprogrammed time (2 minutes factory setting--adjustable) the Computer Board will open the Gas Relay Contact. This allows the Drive Motor to continue to run but without heat. The gas light on the computer board should not be illuminated anytime the computer is in cool down. This Cool Down period allows the clothing (zippers, snaps, etc.) time to cool down to a temperature that is easily handled by customers.

End of Cycle

Top Dryer Used For This Example

At the end of the cool down, the Computer Board opens the Upper Run Relay, which removes power from the Motor Control Relay (R1) and also removes power to the Drive Motor. The motor light on the computer board should no longer be illuminated. The Drive Motor and tumbler stops and the Computer Board display now flashes until the dryer loading door is opened. Once the dryer loading door is opened to remove the clothing the display goes back to vend price.

Wiring Schematic Dryer

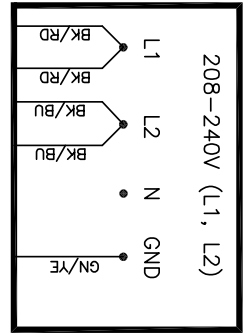

EXTERNAL GROUND MUST BE A NATIONAL/LOCAL ELECTRICAL CODE APPROVED GROUND AND CONNECTED TO THE DRYER GROUNDING TERMINAL.

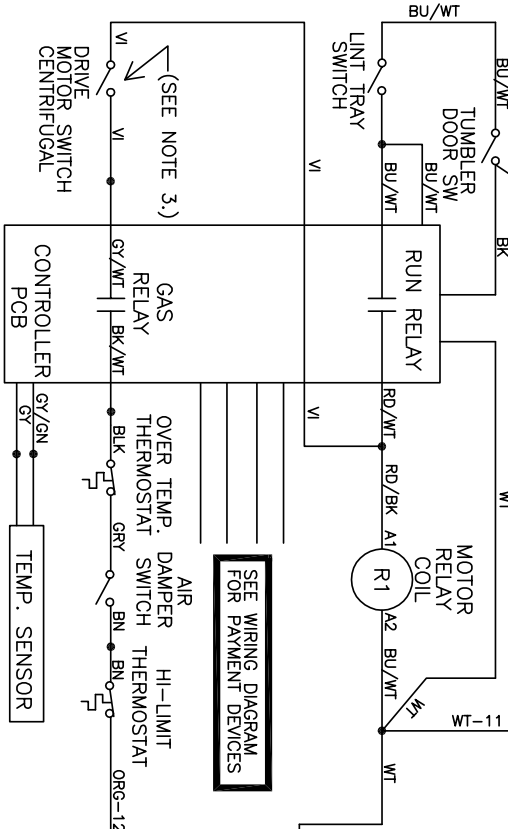
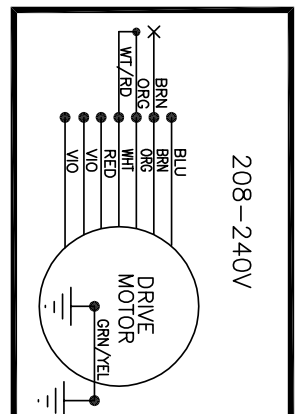
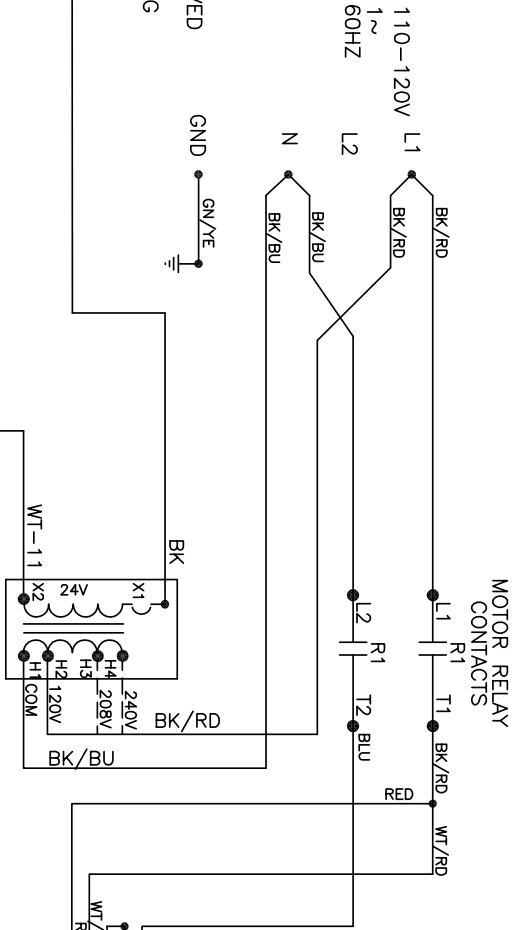

SEE WIRING DIAGRAM FOR PAYMENT DEVICES

CAUTION: LABEL ALL WIRES PRIOR TO DISCONNECTION WHEN SERVICING CONTROLS. WIRING ERRORS CAN CAUSE IMPROPER AND DANGEROUS OPERATION. VERIFY PROPER OPERATION AFTER SERVICING. ATTENTION: AU MOMENT DEL'ENTRIEN DES COMMANDES, ETIQUETEZ TOUS LES FILS AVANT DE LES DERANCHER. DES ERREURS DE CABLAGE PEUVENT ENTRAINER UN FONCTIONNEMENT INADQUAT ET DANGEREUX. S'ASSURER QUE L'APPAREIL FONCTIONNE ADEQUATEMENT UNE FOIS L'ENTRETIEN TERMINE.

9506-826-001PR

SCHEMATIC

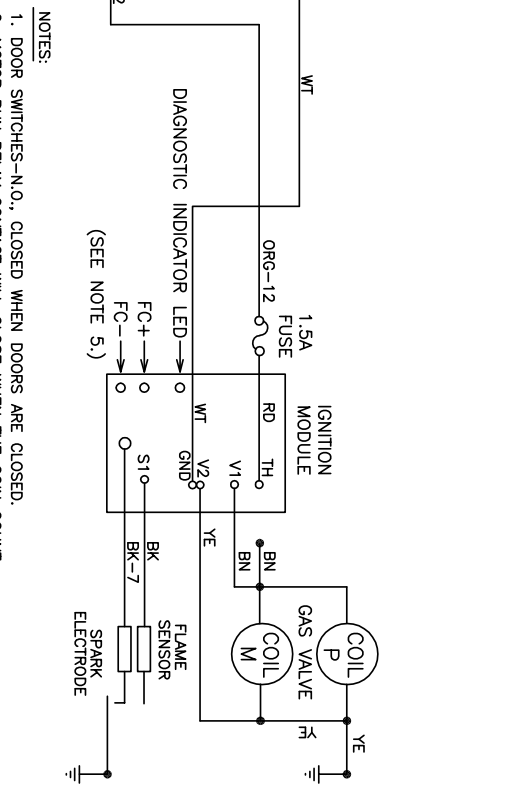

- NOTES:
1. DOOR SWITCHES-N.O., CLOSED WHEN DOORS ARE CLOSED.
 2. MOTOR RUN RELAY CONTACT WILL CLOSE WHEN THE COIN COUNT IS SATISFIED, THE DOOR CLOSED AND THE START BUTTON PRESSED
 3. CENTRIFUGAL SWITCH-N.O., CLOSSES WHEN MOTOR IS UP TO SPEED.
 4. REFER TO OWNER'S MANUAL FOR DESCRIPTION OF OPERATION AND REQUIREMENTS FOR HEATING CIRCUIT.
 5. WITH A DC MICROAMMETER, FLAME CURRENT CAN BE MEASURED AT TEST POINTS. READING SHOULD BE 0.7UA DC OR HIGHER.

DCS030N-15_C_X- - - - -X

Wiring Diagram Dryer

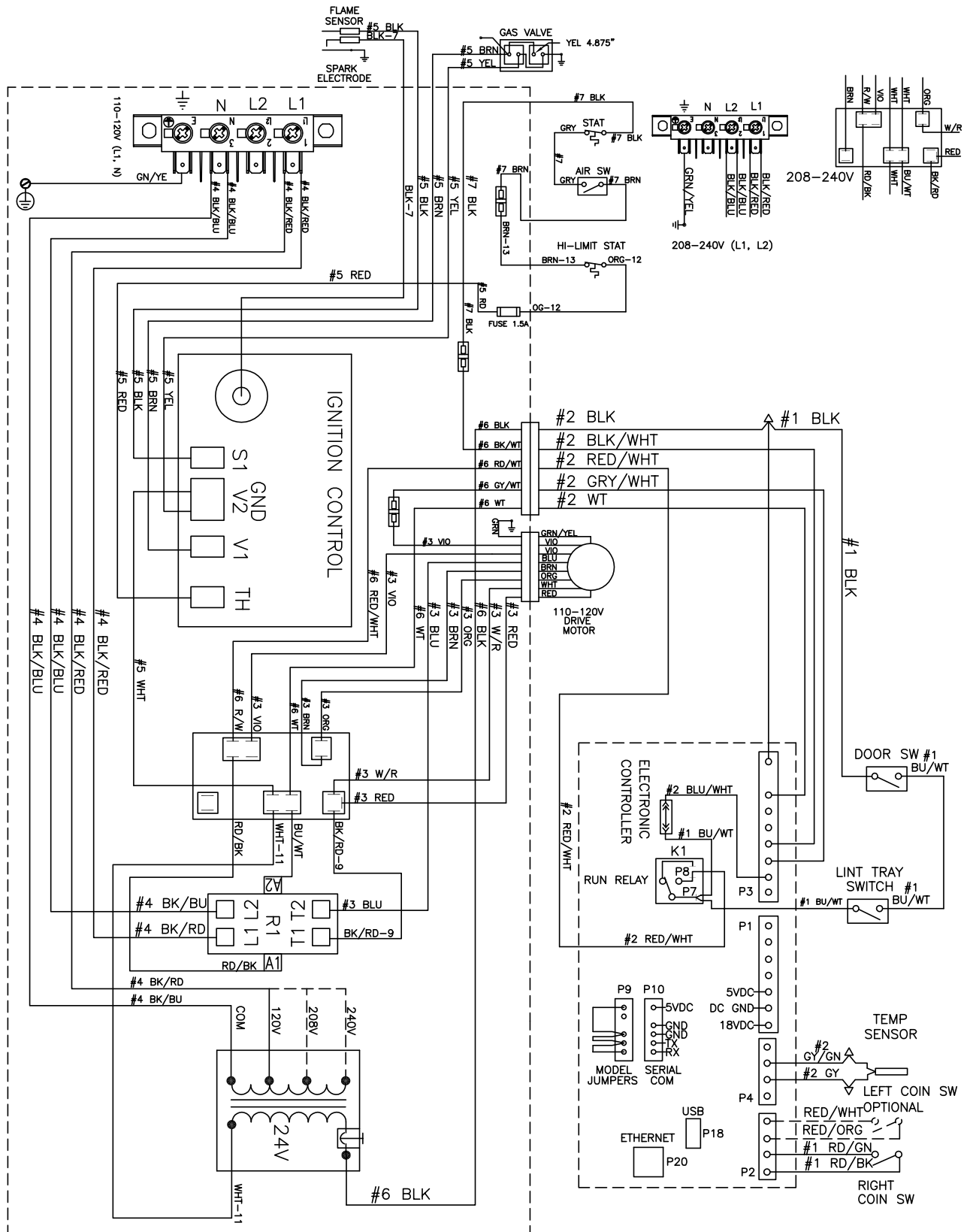

9506-826-001PR WIRING DIAGRAM DCS030N_15_C_X- - - - - X



Section 5:

Dryer Parts Data

SWD

Dryer Cabinet Group

	Description	T-30 SWD	QTY
1	Panel Assy., Front- Upper (SS)	9989-602-001	1
*	Insulation Front Panel, half moon (top)	9277-063-001	1
*	Insulation Front Panel, half moon (bottom)	9277-063-002	1
2	Screw, FLHDCR, 10B x 1	9545-008-014	4
3	Washer, Finish, #10	8641-585-001	4
*	Nut, Spring	8640-399-001	4
*	Hinge ,Backup Plate	9982-386-001	1
*	Screw, Countersink, 10-32X 1/2	9545-012-003	2
4	Strap, Hinge (SS/Black)	9544-072-002	2
*	Screw, Hinge to Panel	9545-012-028	4
*	Door Assy., Loading Complete-SS	9960-256-034	1
*	Door Assy., Loading Complete-Chrome/BLK/SS	9960-256-035	1
5	Door Assy., Loading-SS(ring only)	9960-255-008	1
5	Door Assy., Loading-Chrome(ring only)	9960-255-016	1
6	Plate Assy., Hinge (SS)	9982-280-012	1
*	Screw, Hinge to Door	9545-012-015	4
*	Nut, Hinge to Door	8640-413-002	4
*	Cover, Hinge Plate	9074-341-002	1
*	Screw, Phillips-10B x 3/8	9545-008-010	2
7	Glass, Door	9212-002-003	1
8	Gasket, Glass Black	9206-413-001	1
*	Support, Door Glass	9548-117-000	1
*	Tool Install Dryer Door Gasket	8545-064-001	1
9	Gasket, Outer Rim Black	9206-420-003	1
10	Handle, Loading Door	9244-093-001	1
*	Screw, Handle 1/4-20 x 3/8	9545-018-017	2
11	Stud, Door Catch, 7/8	9531-033-002	1
12	Nut, Hex	8640-413-001	1
13	Nut, Acorn	8640-413-003	1
14	Catch, Loading Door	9086-015-002	1
15	Pop Rivet for mtg. catch	8638-190-009	2
16	Screw, Door to Hinge Strap (Special Black Type)	9545-052-001	1
17	Washer, Fiber	8641-436-003	1
18	Acceptor, Coin	9021-094-001	1
*	Retainer, Coin Acceptor	9486-145-001	2
19	Screw, 4Bx5/8ss, T10	9545-053-002	4
*	Switch, Optical	9801-099-001	1
*	Cabinet Touch Up Paint (White)	9472-001-013	1

Cabinet Group

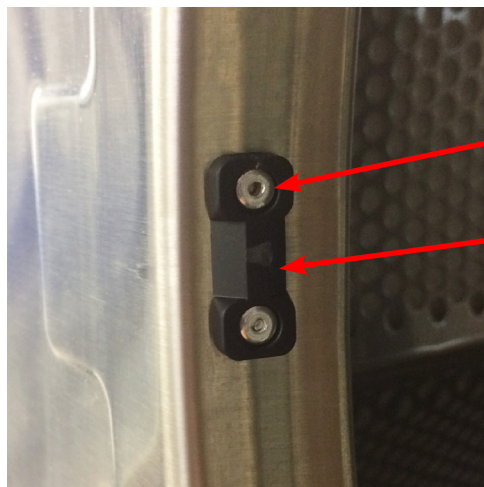
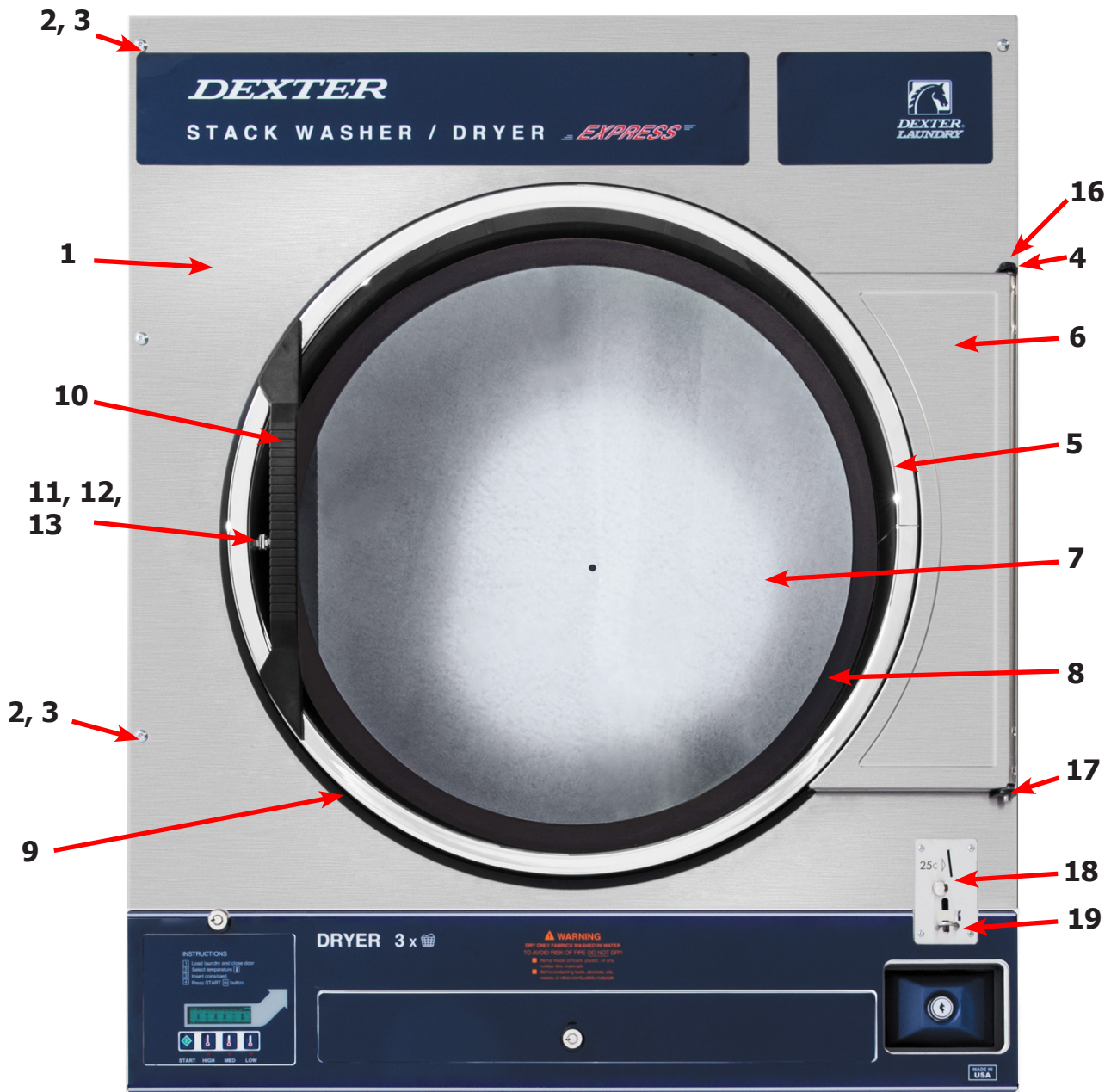

Dryer Cabinet Group

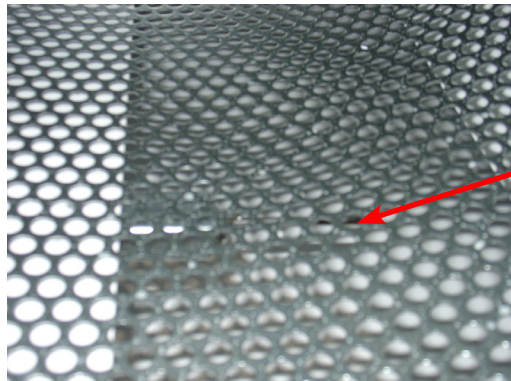

Cabinet Group Continued

Key	Description	T-30 SWD	QTY
20	Escutcheon, SWD, Dryer Coin	9994-041-001	1
21	Trim, Overlay Blue	9435-055-002	1
21	Trim, Overlay Black	9435-055-001	1
*	Screw, #4-40 x 3/16	9545-020-009	13
22	Nameplate Stack Dryer Express Blue	9412-202-002	1
22	Nameplate Stack Dryer Express Black	9412-202-001	1
*	Lint Drawer Assembly Blue	9866-004-001	1
*	Lint Drawer Assembly Black	9866-004-003	1
*	Drawer, Front	9974-010-001	1
*	Washer, Flat, #10	8641-581-006	2
*	Washer, Curved-Spring	8641-569-004	2
*	Nut, 10-32	8640-413-007	2
23	Overlay Trim, Lint Drwr-Blue	9435-003-009	1
23	Overlay Trim, Lint Drwr-Black	9435-003	1
*	Felt Seal (back of lint screen assembly)	9532-074-003	1
*	Lint Screen Assembly ONLY (no front)	9805-029-002	1
*	Replaceable Lint Screen Only	9555-057-009	1
24	Lock and Key, Lint Drawer	8650-012-004	1
*	Key 6101 only	6292-006-010	1
*	Cam, Lock	9095-043-001	1
*	Lint Screen Strap Hold Down Screws 10Bx 1/4	9545-008-001	14
25	Controls Assy, 24VAC, Blue	9857-199-002	1
25	Controls Assy, 24VAC, Black	9857-199-004	1
*	Harness, Electronic Control	9627-913-002	1
26	Lock and Key, Control	8650-012-003	1
*	Cam, Lock	9095-041-001	1
*	Key only 6324	6292-006-007	1
27	Sensor Temp Control	9501-010-001	2
*	Harness, Main	9627-913-003	1
*	Wire Nut Connector Grey	8640-276-002	4
*	Cover, Cabinet (Top)	9074-365-001	1
*	Insulation Cabinet Cover	9277-041-011	1
*	Stack Dryer Trunion Puller	9732-243-002	1
*	Vault, Coin Box	9942-028-005	1
*	Screws, Mounting-Coin Vault	9545-008-024	2
28	Coin Box Assy, Small Blue	9807-099-001	1
28	Coin Box Assy, Small Black	9807-099-003	1
*	Nut, Elastic Stop	8640-413-004	*

Dryer Back Panels and Guards

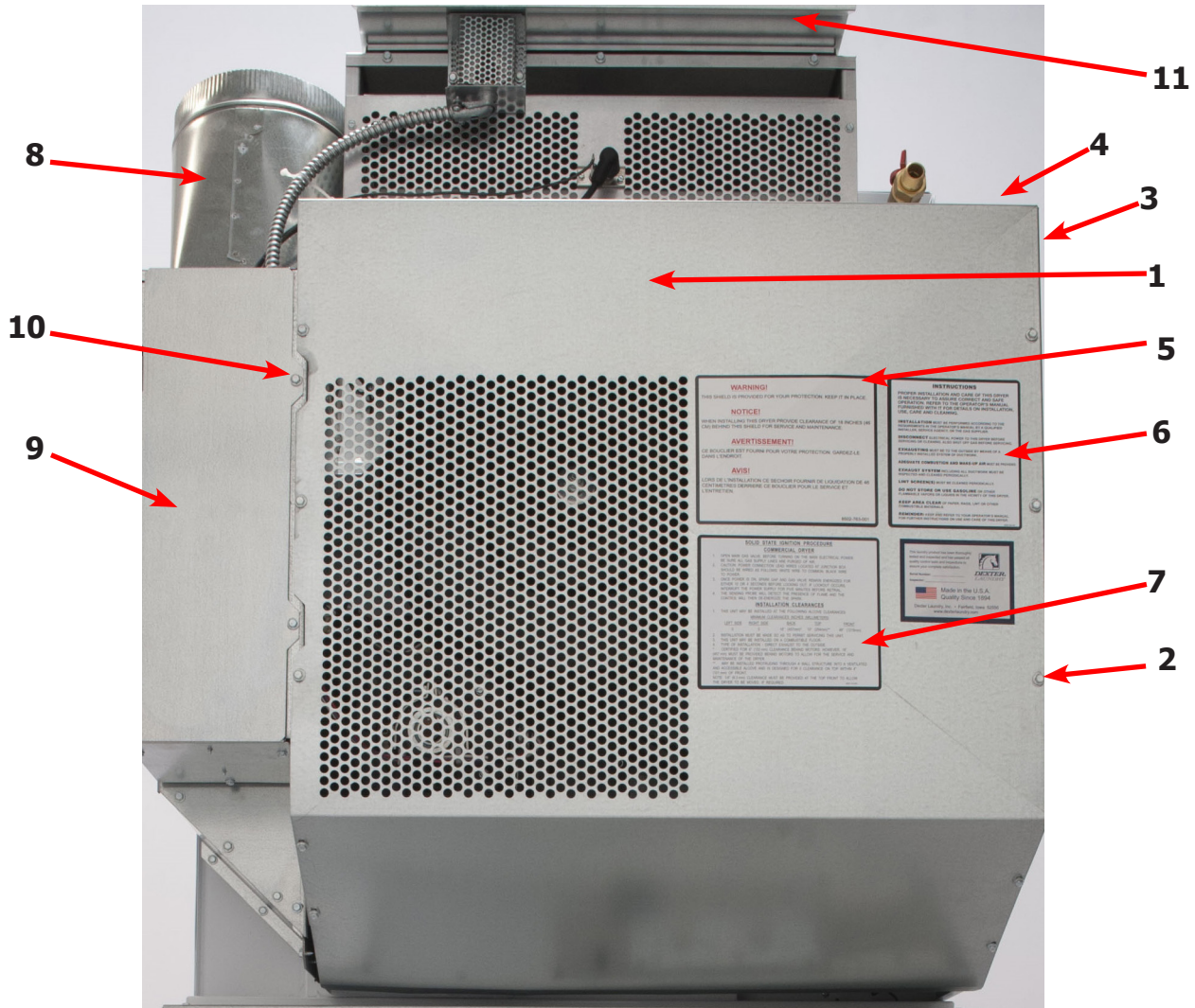

Key	Description	Part Number	Qty
1	Guard, Drive	9208-124-001	1
2	Screw, 10AB x 3/8	9545-008-024	18
3	Panel, Drive Guard,	9208-123-001	1
4	Guard-Small, upper	9208-074-001	1
5	Warning, Lable	8502-763-001	1
6	Lable, Instructions	8502-645-001	1
7	Lighting and Clearence, Label	8527-112-001	1
8	Duct, Transition	9109-129-001	1
9	Door, Cover-Control Box	9108-141-001	1
10	Guard Side, RH	9208-141-001	1
*	Cabinet, Cover	9074-365-001	1
*	Insulation	9277-041-011	1
11	Shield-Burner Inlet	9550-173-001	1
*	Wiring Diagram & Schematic	9506-826-001	1
*	6" Slide Open Clean Out Duct (Optional)	9973-035-001	1

Air Flow Switch Assembly

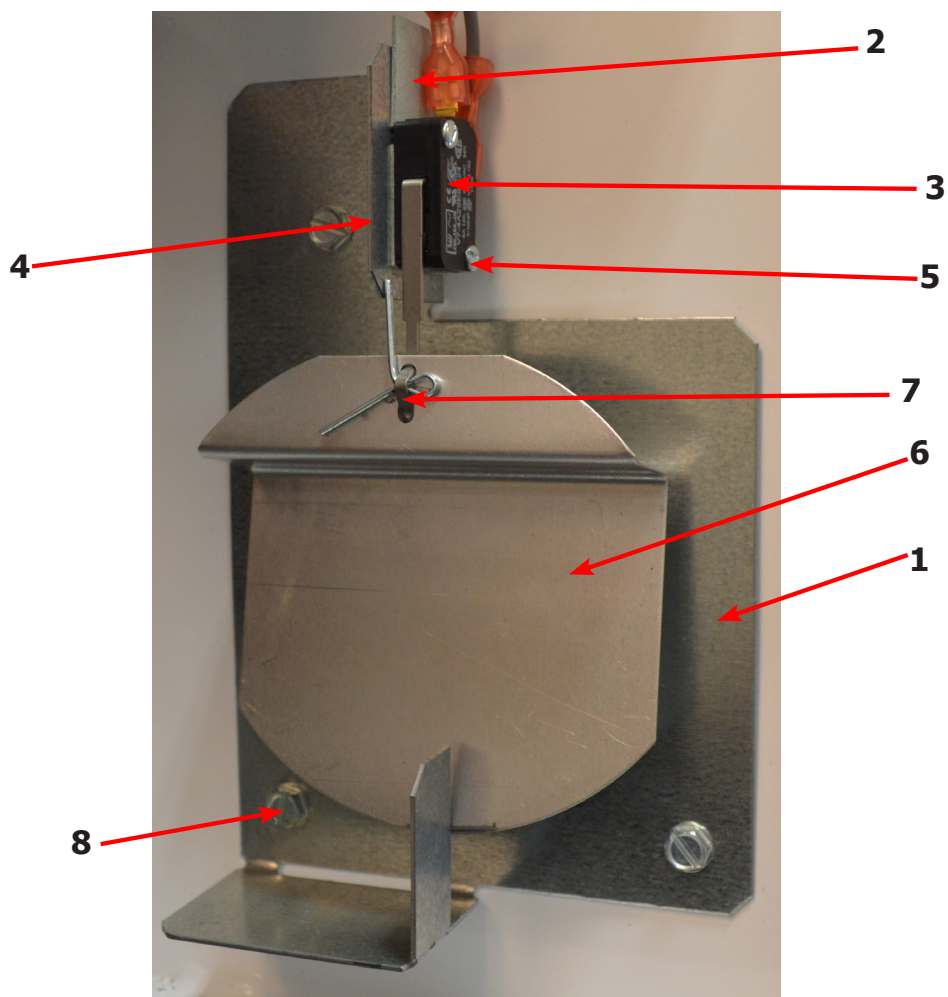

Key	Description	T-30 SWD	QTY
*	Air Flow switch Assy	9801-095-001	2
1	Bracket-Airflow switch	9029-174-001	2
2	Shield-Switch	9550-169-003	2
3	Switch-Micro	9539-461-009	2
4	Nut-Twin, 4-40	8640-401-001	2
5	Screw-.625, 4-40	9545-020-001	2
6	Actuator-Air Flow Switch	9008-007-001	2
7	Pin-Cotter, .09375x.75	9451-169-002	2
8	Screw, 10AB x 3/8	9545-008-024	3
*	Harness Assembly, Overtmp/Airflow	9627-861-001	1

Dryer Burner Housing Group

Key	Description	T-30 SWD	QTY
*	Housing Assembly, Burner (All sheet metal parts not listed)	9803-220-001	1
1	Service Burner Plate Front	9452-730-001	1
2	Screw, 10B X 1/4"	9545-008-001	4
3	Service Plate baffle Recirculation Chamber Clean Out	9452-729-001	1
4	Screw, 10B x 3/8"	9545-008-006	6
5	Angle, Burner Support	9003-220-001	1
*	Screw, 10B x 3/8"	9545-008-006	2
6	Burner, Main	9048-020-001	2
*	Screw 10AB x 3/8"	9545-008-006	2
*	Panel, Back Burner Housing	9454-816-001	1
7	Electrode Assy, Ignition	9875-002-003	1
8	Screw, Electrode Mtg 8B x 1/4"	9545-045-001	2
9	Valve, Gas Shut Off (Optional)	9379-196-001	1
10	Pipe, 1/2 x 4 1/2, BLK	8655-073-044	1
11	Elbow, 1/2 x 90, BLK	8615-104-037	1
12	Nipple, 1/2 x 4 1/2, BLK	8665-073-008	1
13	Control Assy, Gas	9857-134-001	1
14	Manifold, Assy	9381-012-001	1
*	Orifice, Burner-Natural #32	9425-069-009	2
*	Orifice, Burner-LP #50	9425-069-008	2
15	Bracket, Manifold	9029-175-001	2
16	Pipe Plug in end of Burner Manifold	8615-104-038	1
*	Screw, 10B x 3/8"	9545-008-006	2
*	Bracket, High Limit Thermostat	9029-192-001	1
17	Thermostat, Hi-Limit	9576-203-002	1
*	Spacer, Hi-Limit	9538-142-001	2
*	Screw 8B x 3/4"	9545-045-007	2
18	Cover, Hi-Limit Stat	9074-329-001	1
*	Screw, 10B x 3/8"	9545-008-006	2
19	Thermostat, Safety Shutoff	9576-207-008	1
20	Screw, 10B x 3/8"	9545-008-006	2
21	Cover, Safety Stat	9825-062-001	2
*	Screw, 10AB x 3/8	9545-008-006	3
*	Control, Ignition Fenwall (3 trybox)	9857-182-001	1
*	Kit, LP Conversion Honeywell	9732-179-001	1
	Kit, LP Conversion White Rodgers	9732-102-047	
22	Heat Recirculation Duct, (From Exhaust to Burner	9973-033-001	2
*	Screw, 10B x 3/8"	9545-008-006	8
23	Shield-Burner Inlet	9550-173-001	1
*	Make-Up air Vent Kit	9732-333-001	1

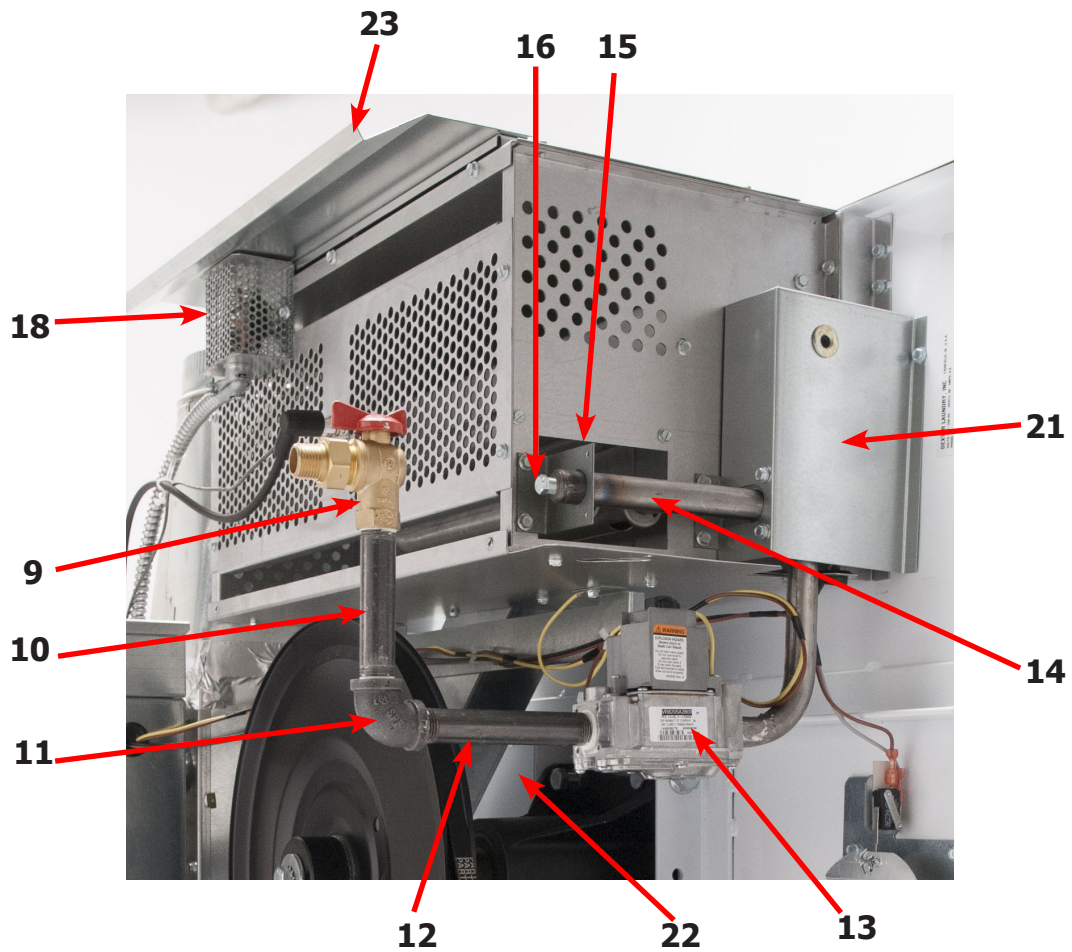
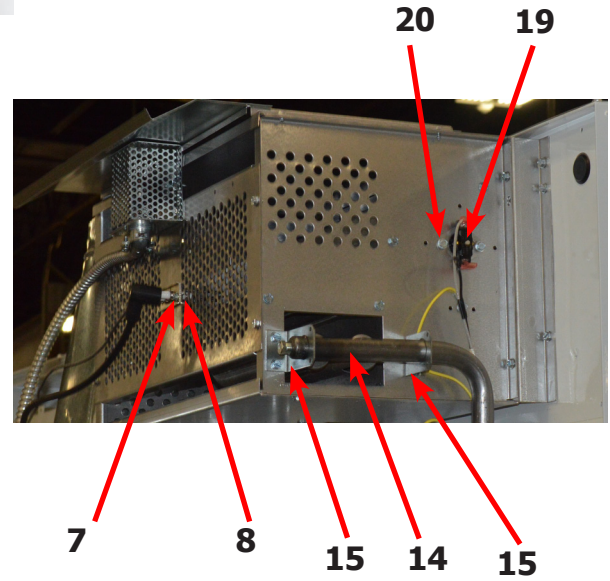
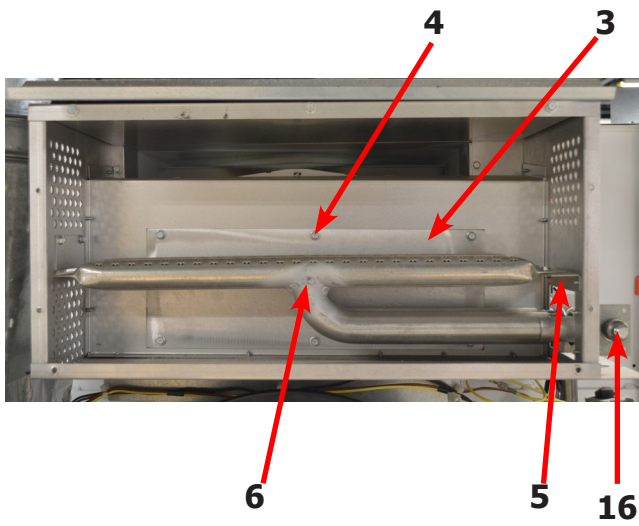
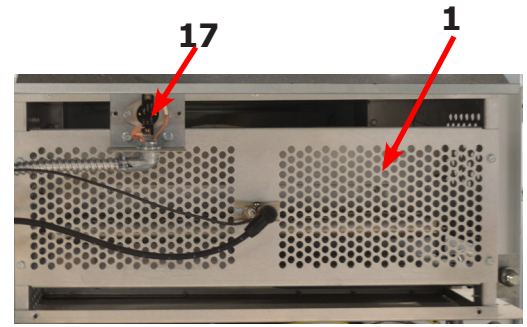
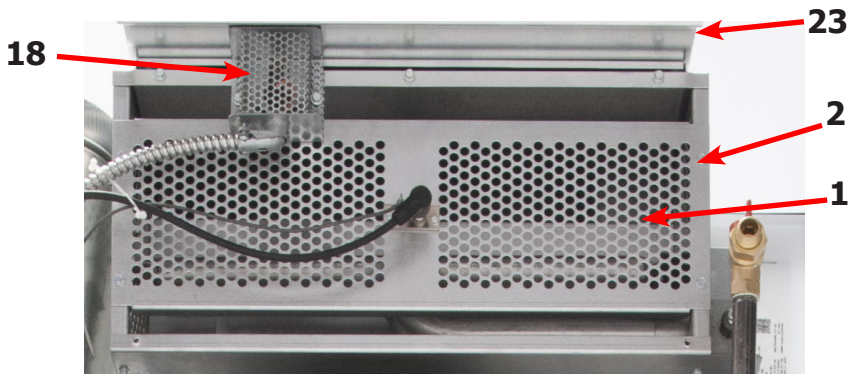

Bearing Housing Group

Key	Description	T-30 SWD	QTY
	Bearing Housing Complete Assy (Includes bearings & Spacer)	9803-160-003	1
1	Housing, Bearing	9241-161-002	1
*	Spacer, Bearing	9538-139-002	1
2	Bearing, Ball, Front & Rear	9036-130-001	2
3	Screw-Wizlock, 3/8-24x3/4	9545-049-002	4
4	Nut, 3/8-24	8640-400-002	4
5	Screw, 3/8-24x1	9545-049-001	2
6	Nut, 3/8-24	8640-415-002	2

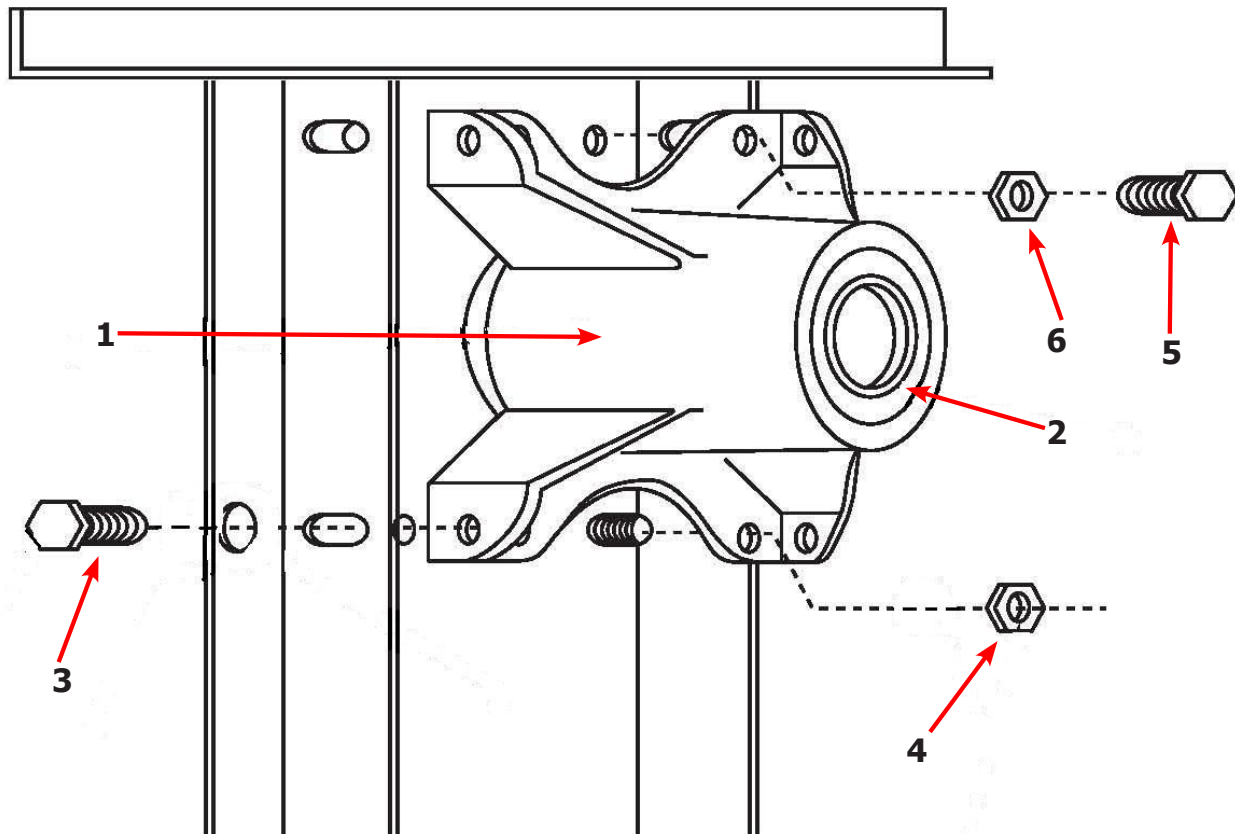
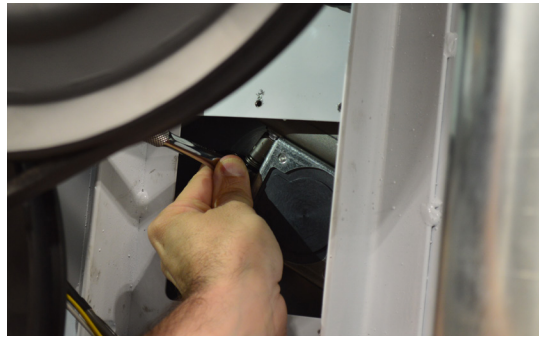

Tumbler Group

Key	Description	T-30 SWD	QTY
*	Tumbler Assy Complete W/Spider (GALV)	9848-147-001	1
1	Tumbler Assy (Galvanized)	9848-146-001	1
*	Tumbler Assy Complete W/Spider (SS & Galv front)	9848-147-002	1
1	Tumbler Assy (Stainless Galvanized front)	9848-146-002	1
2	Rod, Tumbler	9497-019-003	3
3	Washer, Special	8641-554-001	3
4	Shim	9552-013-003	AR
5	Spider Assy	9568-015-001	1
6	Nut, Wiz Lock	8640-415-004	3
7	Spacer-Shaft	9538-164-002	1
8	Tolerance Ring	9487-234-005	1
9	Pulley, Driven	9908-049-002	1
10	Washer -Flat 1/2	8641-581-026	1
11	LockWasher - IntTooth, 1"	8641-582-016	1
12	Screw, 1/2-13x1 1/4	9545-017-009	1
*	Belt, Drive	9040-073-009	2

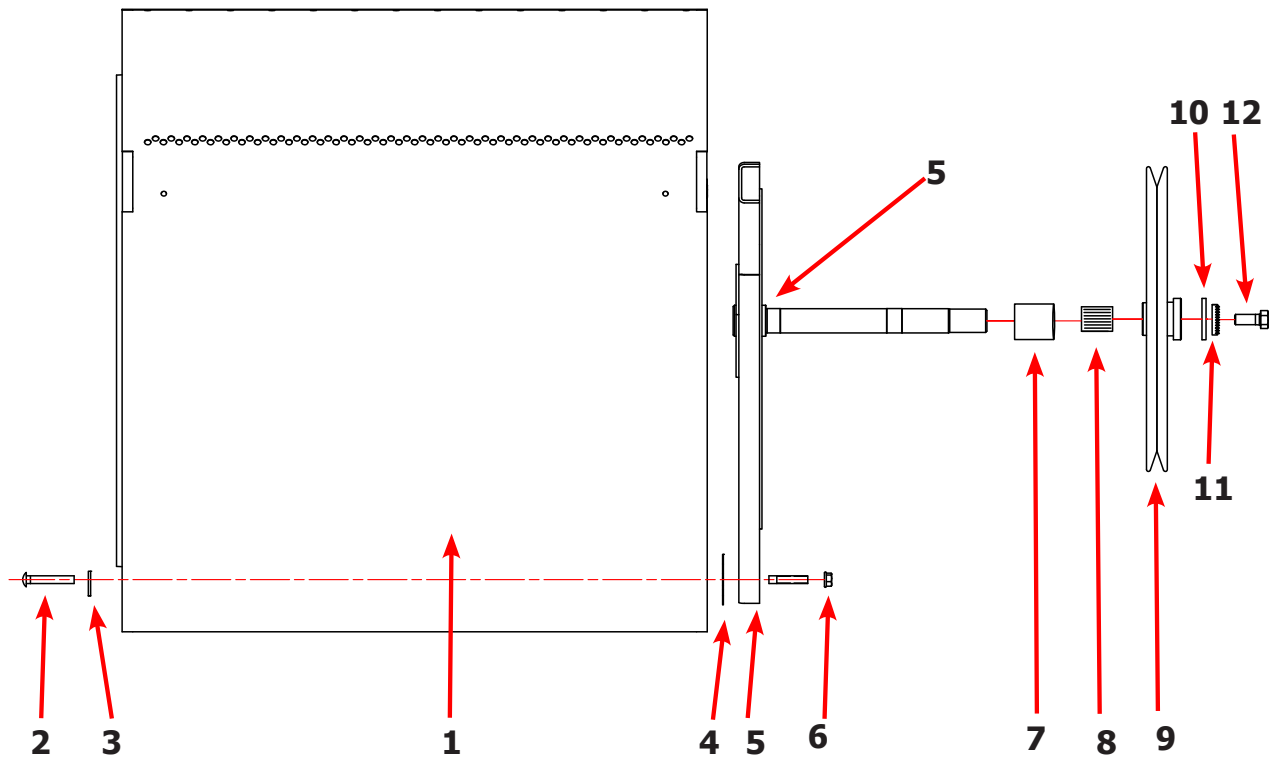

	Description	T-30 SWD	QTY
*	Wire Harness Overtemperature Switch	9627-861-001	1
*	Switch Assy, Air Flow	9801-095-001	1
1	Switch, Air Flow	9539-461-009	1
2	Bracket, Switch- Air Flow	9029-174-001	1
3	Actuator, Switch	9008-007-001	1
4	Pin, Cotter	9451-169-002	1
5	Screw 4-40 x 5/8"	9545-020-001	2
*	Nut, Special Twin .#4-40	8640-401-001	1
*	Shield, Switch	9550-169-003	1
*	Screw 10 Bx 1/4"	9545-008-001	3
7	Motor, Drive	9376-331-001	1
*	Tumble Capacitor	5191-108-002	1
*	Start Capacitor	5191-109-002	1
8	Plate, Motor Mtg	9452-740-001	1
*	Bolt 3/8" - 16 x 3/4"	9545-029-008	1
*	Lockwash Spring 3/8	8641-582-003	1
9	Screw, Motor Plate to Back Assy. 1/4-20x 2 1/2	9545-018-019	4
9	Lockwasher 1/4	86411-582-007	4
9	Spacer	9538-163-006	4
9	Flat Washer 1/4 x 7/8.	8641-581-017	4
9	Rubber Grommet	9209-086-002	4
*	Grommet Spacers	9538-166-006	4
*	Screw, Set	9545-028-013	4
10	Back Assy, Blower Hsg	9962-017-002	1
*	Nut 1/4x20	8640-414-004	7
*	lock washer	8640-582-007	7
*	Clamp-cable,3/4	8654-125-004	2
*	Screw-hxhdsLtdmach,12abx1/2	9545-048-001	2
11	SupportAssy, Intermed. Pulley	9991-053-001	1
12	Bolt, Rd Hd 3/8-16 x 1 1/4	9545-029-010	3
13	Bolt, 3/8-16 x 1 1/2	9545-029-003	1
12	Nut Flange Wizioc 3/8" - 16	8640-415-004	3
*	Washer, Flat	8641-581-035	1
14	Arm Assy-Tension, Complete	9861-022-001	1
*	Washer, Flat	8641-581-035	1

Rear View Photos

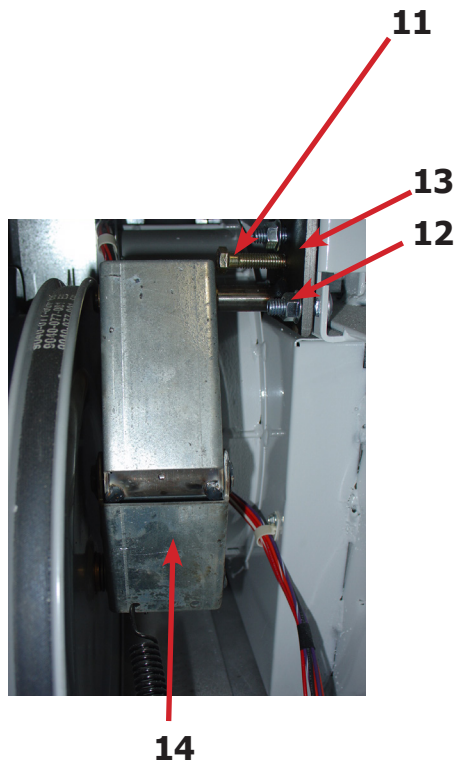
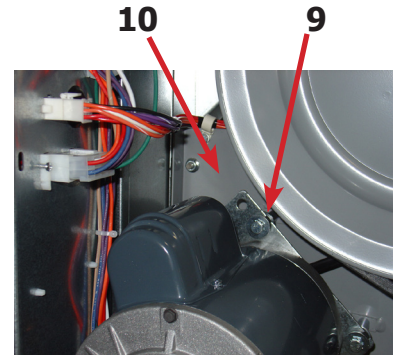
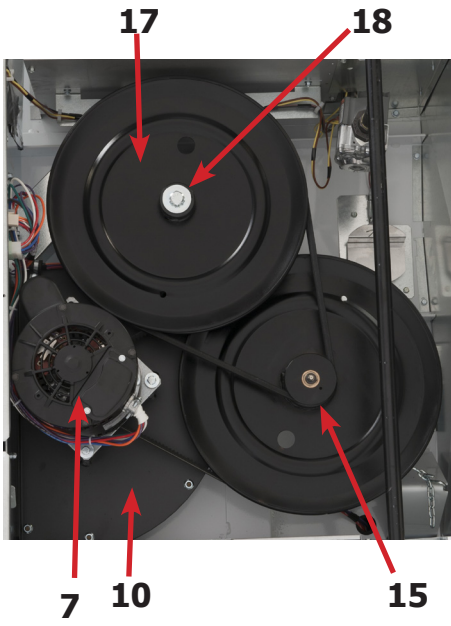
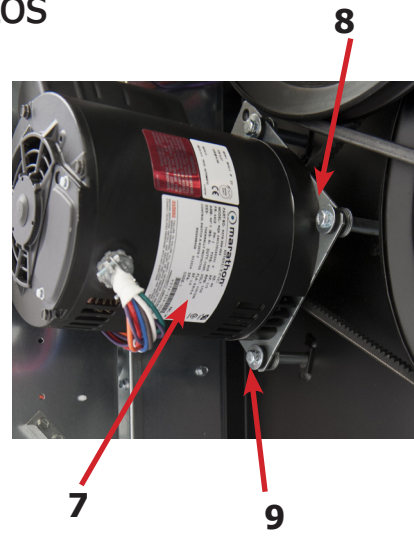
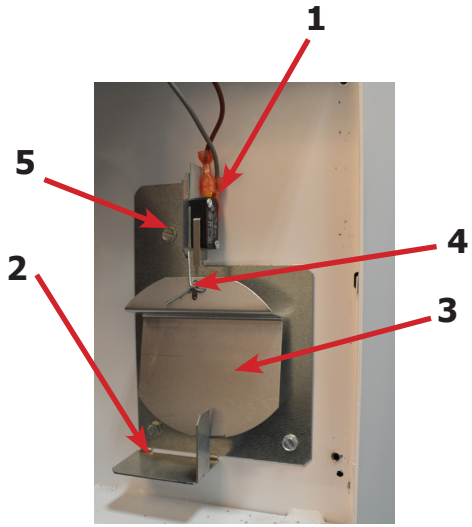

	Description	T-30 SWD	QTY
14	Arm Assy-Tension, Complete	9861-022-001	1
*	Washer, Flat	8641-581-035	1
15	Ring-Retaining	9487-200-003	1
16	Pulley Assy, Intermediate with bronze flange bearing	9908-039-004	1
*	Bearing - Bronze Flange	9036-145-002	1
*	Spacer-Shaft (See Tumbler Group for Expanded View)	9538-164-002	1
*	Tolerance Ring	9487-234-005	1
17	Pulley, Driven	9908-049-002	1
18	Washer -Flat	8641-581-026	1
18	LockWasher - IntTooth, 1"	8641-582-016	1
18	Screw, 1/2-13x1 1/4	9545-017-009	1
19	Belt, Drive- Motor	9040-077-001	1
20	Belt, Drive- Tumbler	9040-073-009	1
21	Spring, Tension	9534-319-002	1
22	Chain, Tension	9099-012-002	1
23	Hook, Tension	9248-022-002	1
*	Damper Inside Duct Exhaust	9125-007-002	1
24	Pin, Damper Hinge	9451-146-001	1
*	Nut, Spring	8520-141-000	2
*	Screw #10B x 1/2	9545-008-026	3
*	Cover Duct Upper	9825-380-001	1
*	Base Duct	9047-118-001	1
*	Screw 10ABx 3/8"	9545-008-024	40
26	Impeller, W/Set Screws	9278-040-001	1
27	Pulley, Motor	9453-157-001	1
25	Heat Recirculation Assembly Duct	9973-033-001	1
*	Bracket for Wire Harness Under Burner Housing	9029-173-001	1

Rear View Photos

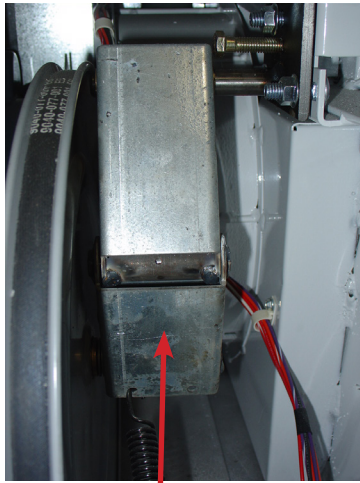

14



17

18

19 20

15 16



21

22

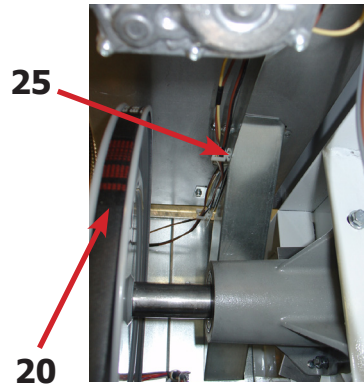

25

20

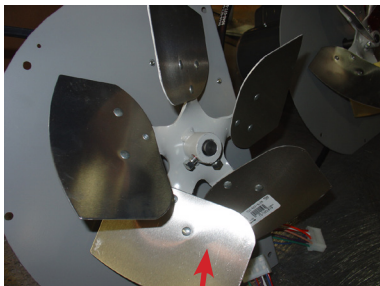

26

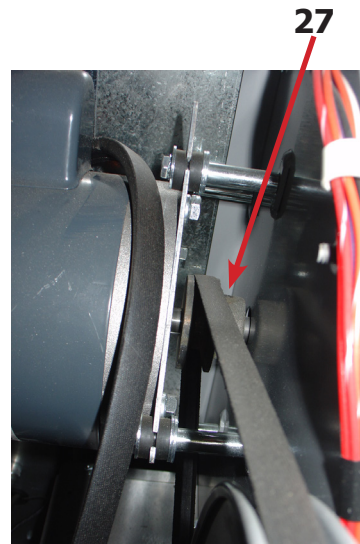

27

Control Assembly Group

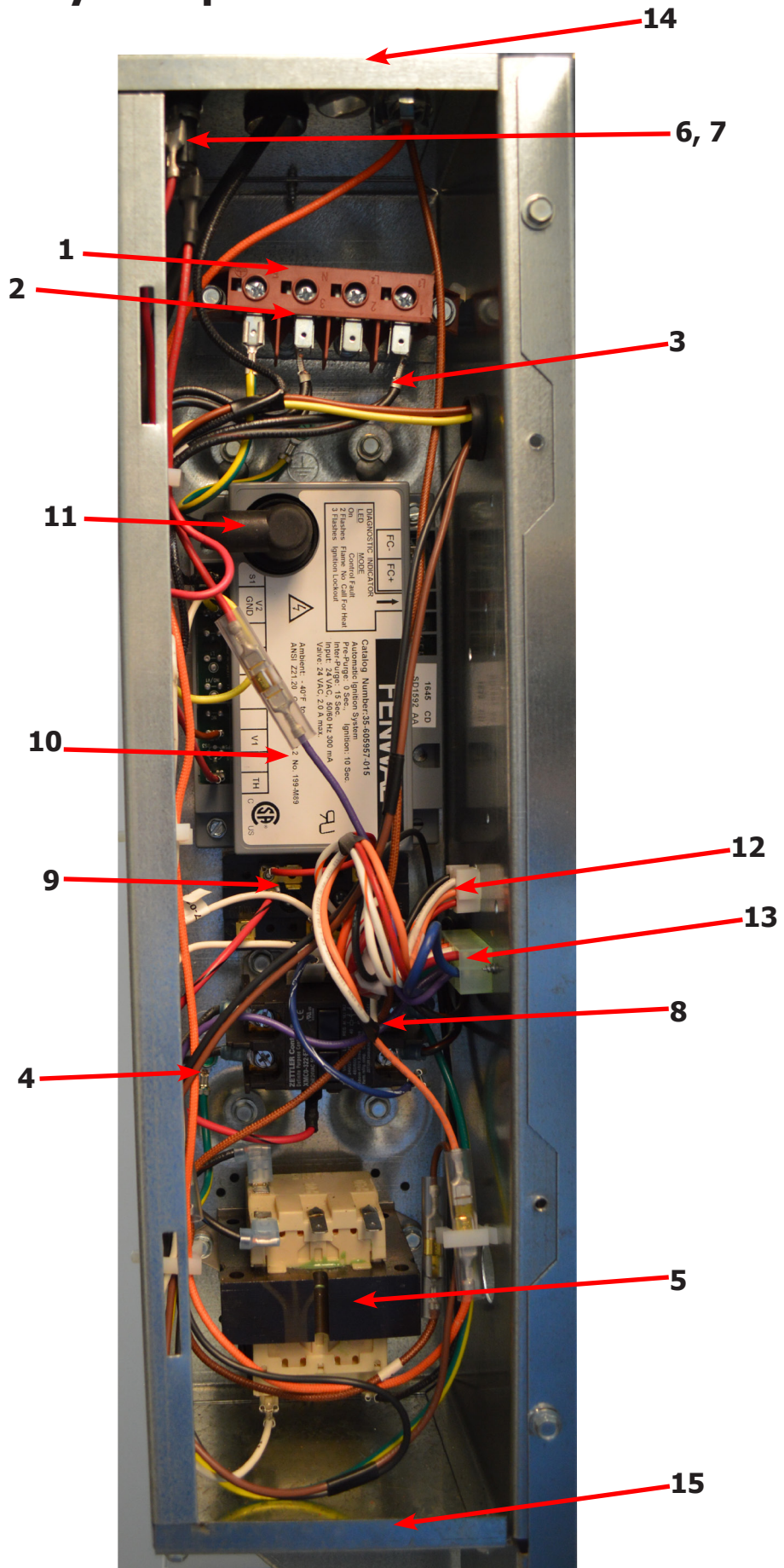

Control Assembly Group

Key	Description	T-30 SWD	QTY
*	Control, Rear	9857-233-001	1
*	Bracket, Terminal Block Power	9029-202-001	1
1	Strip, Terminal Marker	9558-029-003	1
2	Terminal-Block, Power, 4 Pole	9897-035-001	1
*	Screw, 10AB x 3/8"	9545-008-024	4
3	Harness Assembly-Power Main Fork, Upper	9627-859-007	1
4	Wire Assembly-Ground, GRN/YEL, 7"	8220-137-002	1
*	Lock Washer, Ext tooth #110	8641-582-006	1
*	Screw, 10-32 x 1/2"	9545-008-027	1
5	Transformer, 208/240/60Hz. 24/120VA	8711-007-002	1
*	Screw, 10AB x 3/8"	9545-008-024	2
6	Fuse Holder Assembly	9200-001-002	1
7	Fuse, 1.5Amp/250V-Fast Acting	8636-018-001	1
8	Relay, Motor, 30Amp 24VAC	5192-299-002	1
*	Screw, Phillips, 8AB x 1/2"	9545-045-012	2
9	Terminal Block, Power	9897-026-001	1
*	Screw, Phillips, 8AB x 1/2"	9545-045-012	2
*	Harness-Assembly, Low Voltage, Upper	9627-867-011	1
10	Ignition Module	9857-182-001	1
*	Screw, 10AB x 3/4"	9545-008-018	2
11	Wire Assembly, High Voltage	9631-403-009	1
*	Door-Control Box	9108-141-001	1
*	Screw, 10AB x 3/8"	9545-008-024	3
12	Harness, Main (Internal Box)	9627-863-003	1
*	Harness Main Extention (External Box)	9627-913-003	1
13	Harness Motor	9627-864-007	1
14	Control Box Panel Upper	9454-943-001	1
15	Control Box Panel Lower	9454-697-001	1
*	Control Box Wrapper	9636-216-001	1
*	Wire Red/Black 8"	8220-062-047	1
*	Wire White #11, 14"	8220-062-038	1
*	Wire-Blue/White 5.5"	8220-062-026	1
*	Wire Black/Red #9 9"	8220-146-001	1

Door Switch Group

Key	Description	T-30 SWD	QTY
1	Door Switches	9539-487-001	2
2	Bracket-Mounting lint tray switch	9029-303-001	1
3	Conduit-Wire	6068-051-001	1
*	Grommet Wire 1/2 i.d.	9029-089-001	1

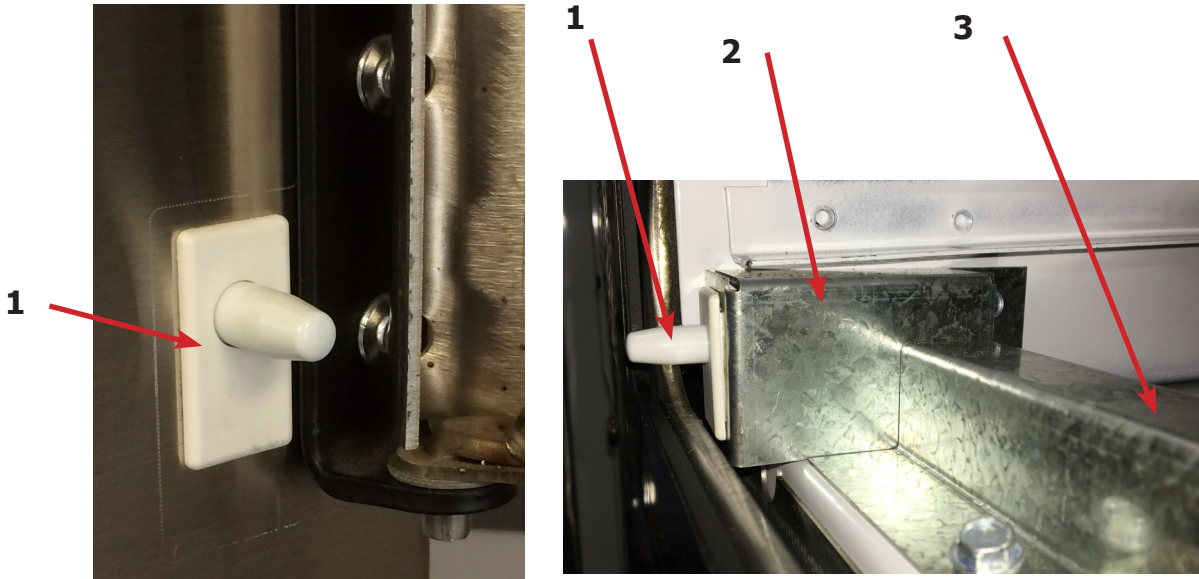

Hinge Plate Cover

Key	Description	T-30 SWD	QTY
1	Cover-Hinge, Black	9074-341-002	1
2	Screw-TRHDCR, 10B x 3/8, Black	9545-008-010	2

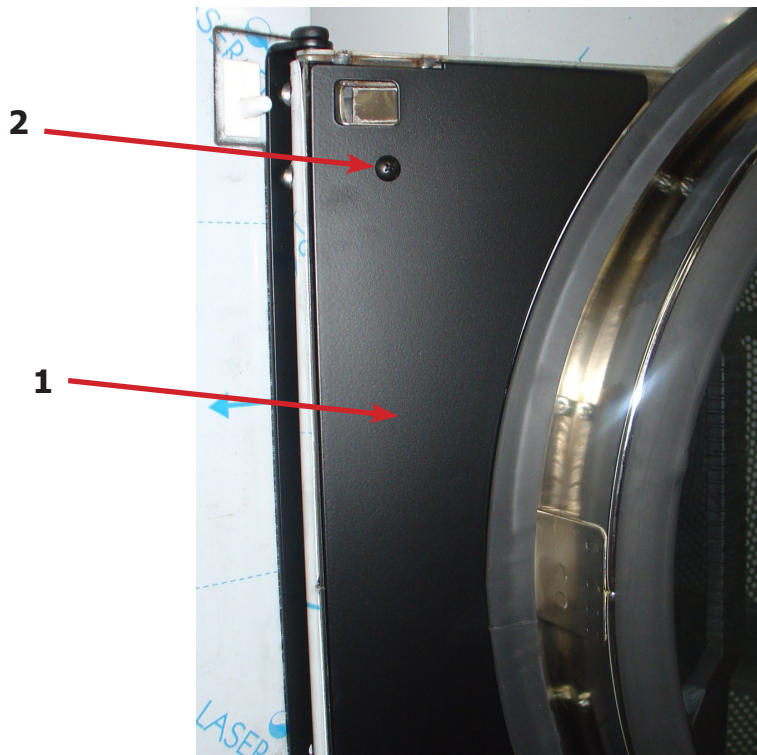

Wiring Diagram

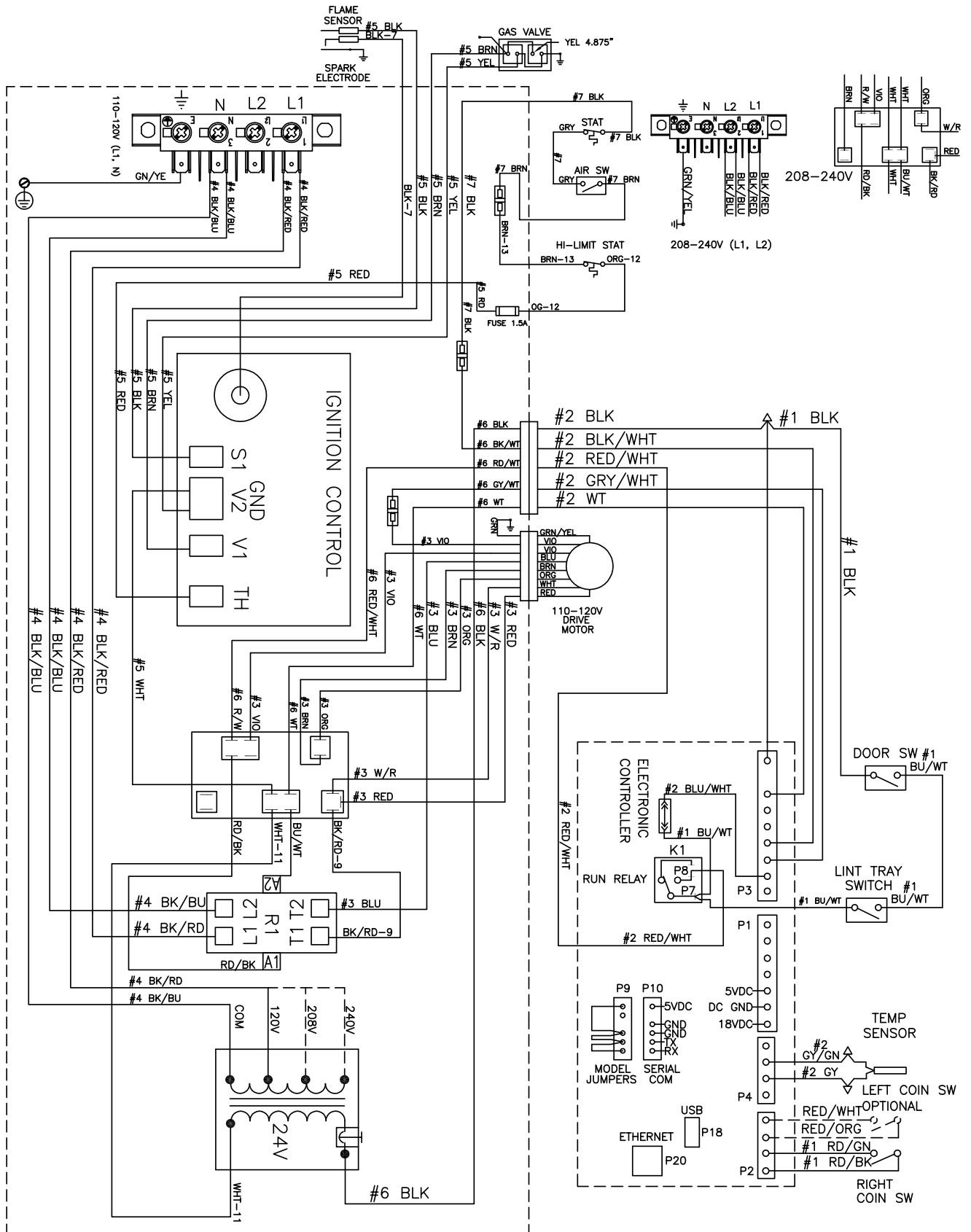

9506-826-001PR WIRING DIAGRAM DCS030N-15_C_X-____-__X

Wiring Schematic

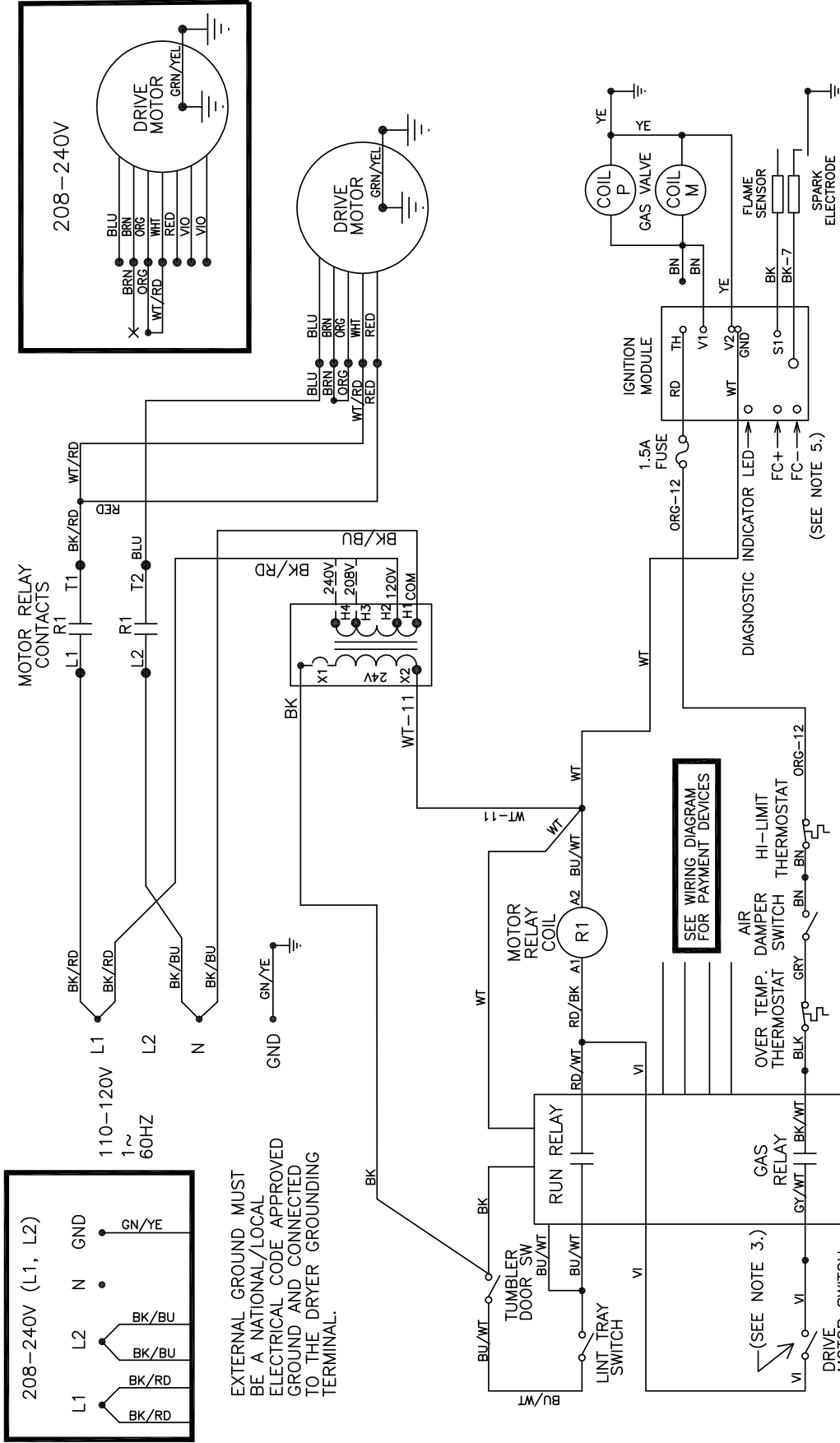

CAUTION: LABEL ALL WIRES PRIOR TO DISCONNECTION WHEN SERVICING CONTROLS. WIRING ERRORS CAN CAUSE IMPROPER AND DANGEROUS OPERATION. VERIFY PROPER OPERATION AFTER SERVICING.

ATTENTION: AU MOMENT DEL'ENTRIEN DES COMMANDES, ÉTIQUETEZ TOUS LES FILS AVANT DE LES DÉBRANCHER. DES ERREURS DE CÂBLAGE PEUVENT ENTRAINER UN FONCTIONNEMENT INADÉQUAT ET DANGEREUX. S'ASSURER QUE L'APPAREIL FONCTIONNE ADEQUATEMENT UNE FOIS L'ENTRETIEN TERMINÉ.

NOTES:

1. DOOR SWITCHES-N.O., CLOSED WHEN DOORS ARE CLOSED.
2. MOTOR RUN RELAY CONTACT WILL CLOSE WHEN THE COIN COUNT IS SATISFIED, THE DOOR CLOSED AND THE START BUTTON PRESSED
3. CENTRIFUGAL SWITCH-N.O., CLOSSES WHEN MOTOR IS UP TO SPEED.
4. REFER TO OWNER'S MANUAL FOR DESCRIPTION OF OPERATION AND REQUIREMENTS FOR HEATING CIRCUIT.
5. WITH A DC MICROAMMETER, FLAME CURRENT CAN BE MEASURED AT TEST POINTS. READING SHOULD BE 0.7uA DC OR HIGHER.

Coin Handling Group

Key	Description	Part Number	Qty
	Coin Acceptor, Optical, SWD, US Quarter	9021-094-001	1
*	Harness-Extention ,Control to Acceptor, Optical Dryer	9627-916-002	1
*	Retainer, Coin Acceptor	9486-145-001	1
*	Screw, Torx	9545-053-002	4
1	Switch Assembly, Optical Sensor, SWD	9801-099-003	1
*	Screw-Height Bar, 3mm	9545-039-002	2
	Below not included		
*	Harness, Acceptor Mechanical (Control to Acceptor)	9627-783-003	1
*	Coin Vault	9942-027-015	1
	Screw, 10AB X 3/8	9545-008-024	2

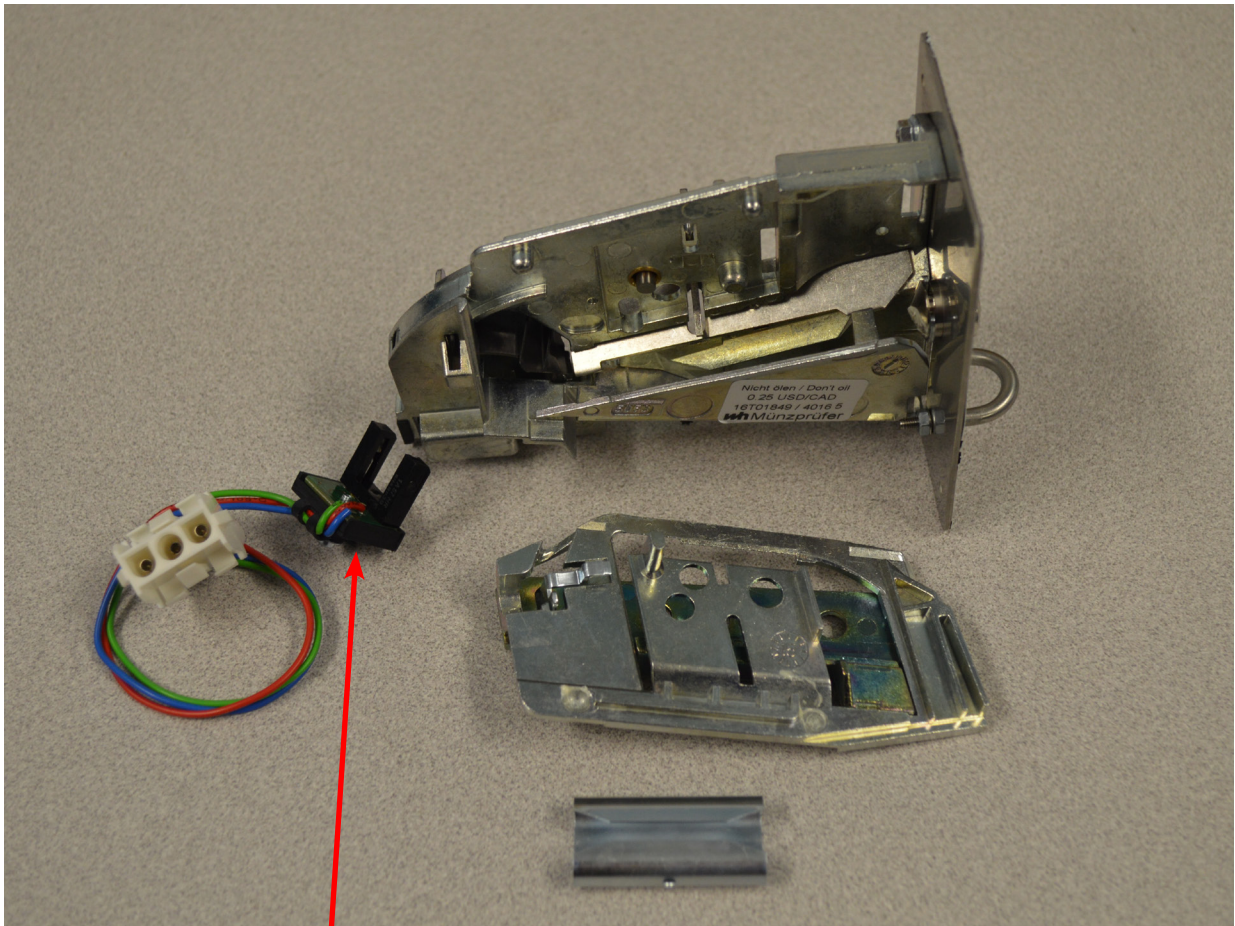

1

Coin Handling Group Electronic

Key	Description	Part Number	Qty
	Kit, Electronic Coin Acceptor	9732-303-004	1
	Acceptor-Electronic, US/CA	9021-054-001	1
	Harness, Control to Acceptor, Dryer	9627-909-003	1
	Harness, Control to Acceptor, Washerr	9627-909-002	1
	Lable-Wiring, Electronic Acceptor	8502-730-001	1
	Retainer Coin Acceptor, Electronic	9486-155-001	2
	Screw, 4B x 5/8 ss, Torx T-10	9545-053-002	4
	Below not included		
	Harness, Adaptor Electronic to Mechanical switch	9627-901-001	

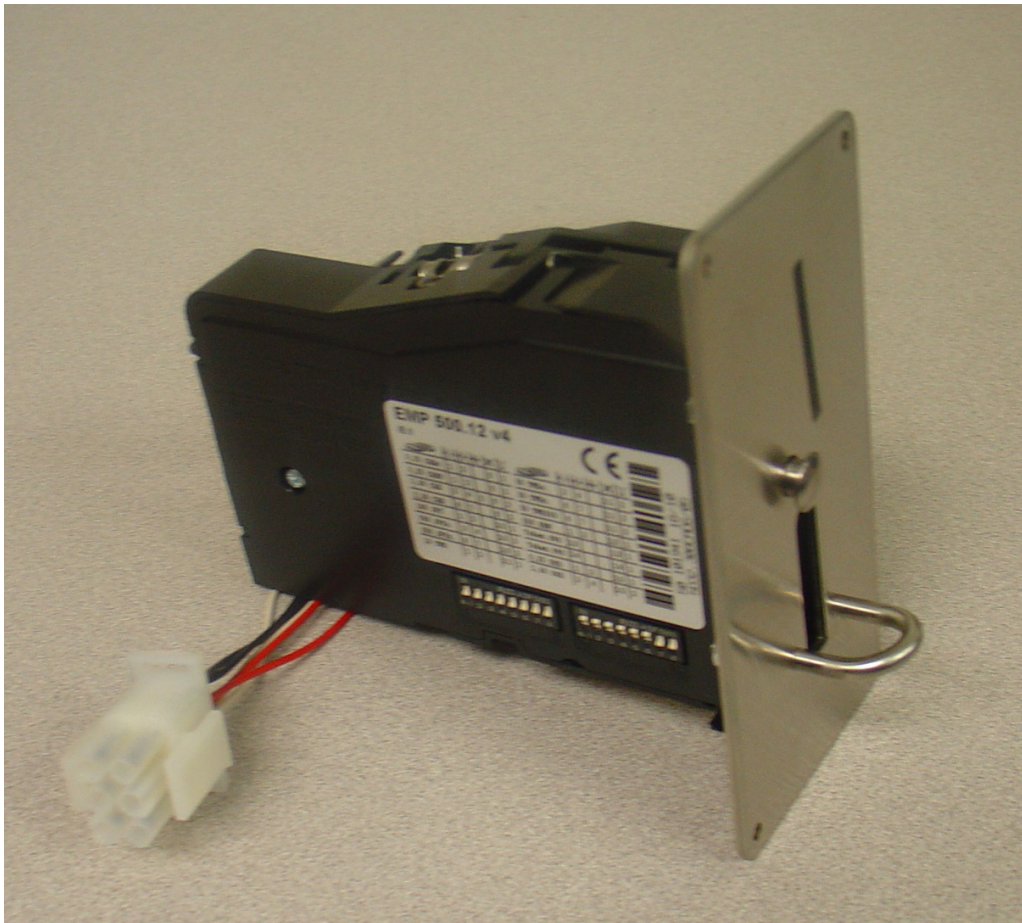

Section 6:

50 Hz Gas Dryer

-39 T-30 SWD 50 Hz Parts

Key	Description	Part Number	Qty
*	Strip, Terminal Marker -39 Models	9558-029-004	1
1	Transformer	8711-007-002	1
*	Instructions, Transformer Connect	8507-230-003	1
2	Ignition Control -39 Models	9857-182-001	1
*	Harness-Ignition Control,	9627-867-011	1
3	Wire Assembly High Voltage	9631-403-009	1
4	Motor	9376-318-002	1
5	Pulley, Motor Drive	9453-169-009	1
6	Harness Motor Extension	9627-864-007	1
*	Wiring Label Schematic/Diagram -39 models	9506-826-001	1
*	Owner's Manual	8514-286-001	1
*	Lint Drawer Assembly -39 Models	9866-004-001	1

Rear View Photos

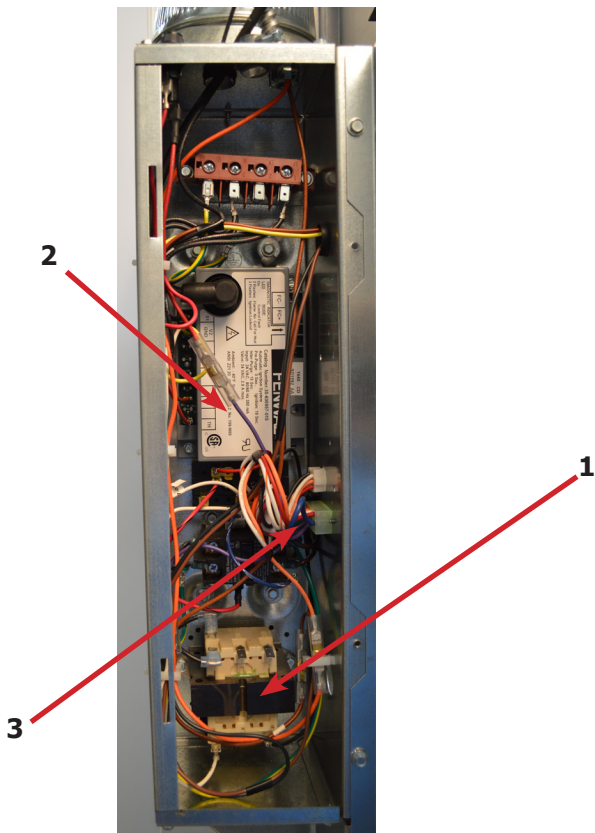
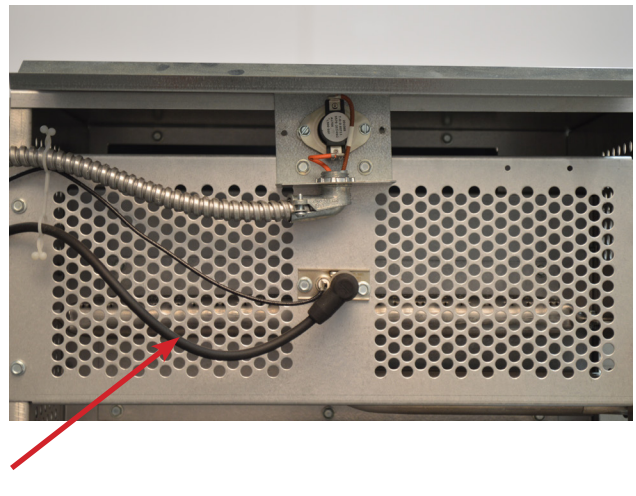
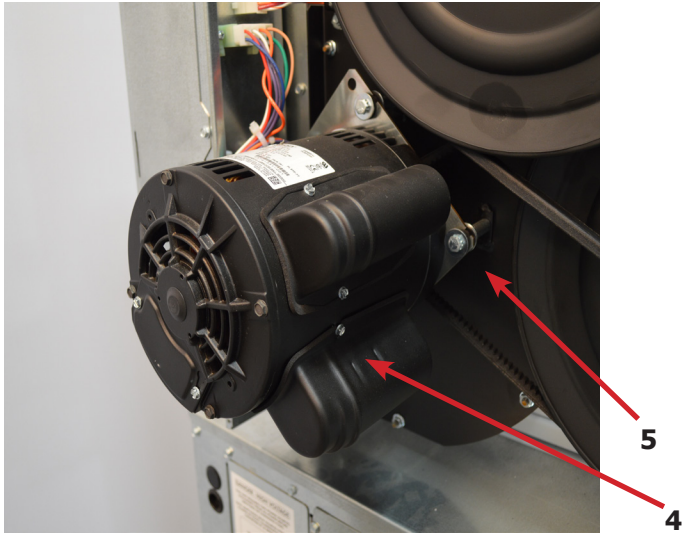

T-30 SWD -39 Gas Control Parts

Key	Description	Part Number	Qty
1	Kit-Honeywell VR86 Valve Flange	9732-162-001	1
*	Orifice, Main Burner #32	9425-069-009	2
2	Gas Control Valve	9857-132-004	1

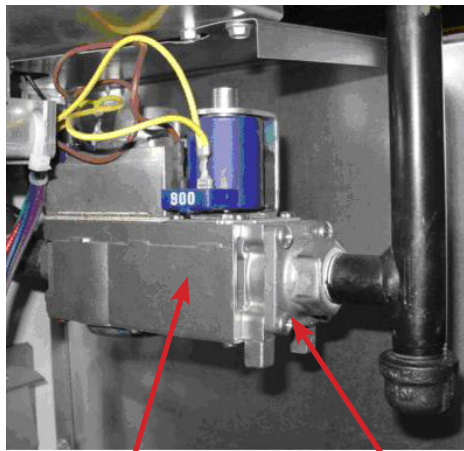

2

1

Coin Handling Group Electronic

Key	Description	Part Number	Qty
	Kit, Electronic Coin Acceptor	9732-303-004	1
	Acceptor-Electronic,	9021-054-001	1
	Harness, Control to Acceptor, Dryer (w/o lint door switch)	9627-909-003	1
	Harness, Control to Acceptor, Dryer (with lint door switch)	9627-909-005	1
	Harness, Control to Acceptor, Washerr	9627-909-002	1
	Label-Wiring, Electronic Acceptor	8502-730-001	1
	Retainer Coin Acceptor, Electronic	9486-155-001	2
	Screw, 4B x 5/8 ss, Torx T-10	9545-053-002	4
	Below not included		
	Harness, Adaptor Electronic to Mechanical switch	9627-901-001	1

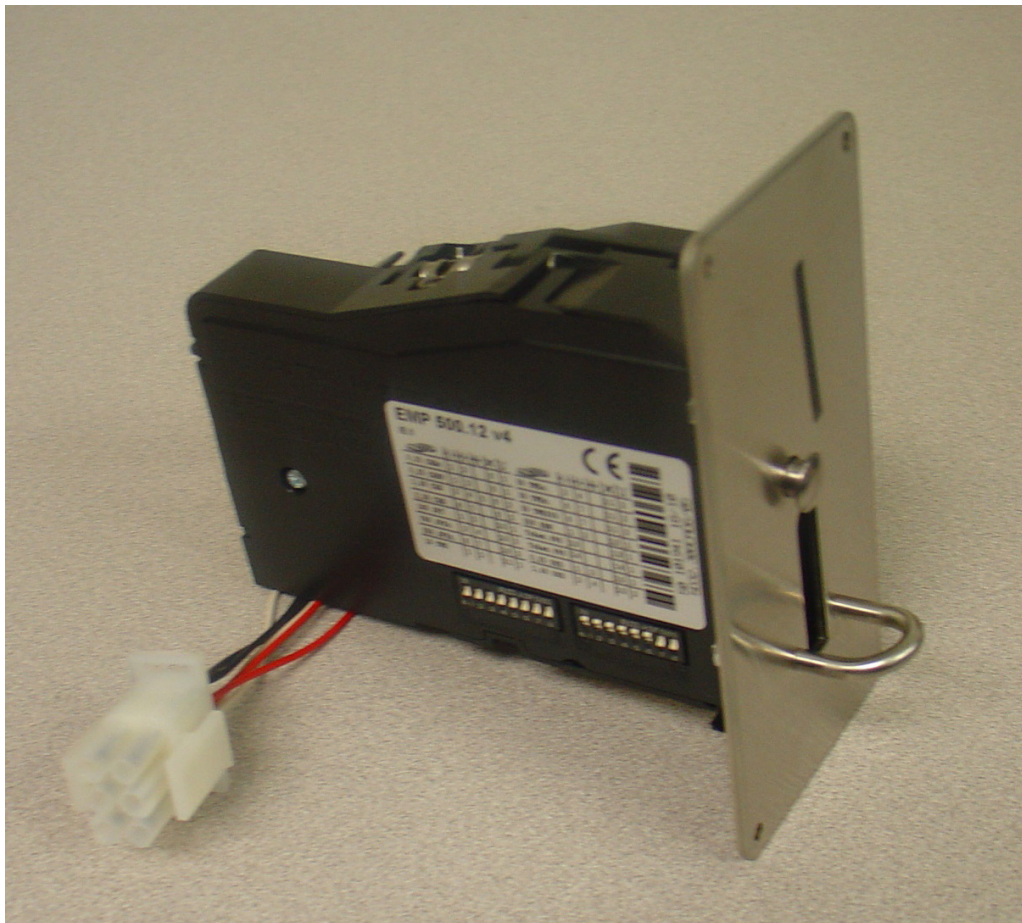

Wiring Schematic for Dryer 50hz 230V

EXTERNAL GROUND MUST BE A NATIONAL/LOCAL ELECTRICAL CODE APPROVED GROUND AND CONNECTED TO THE DRYER GROUNDING TERMINAL.

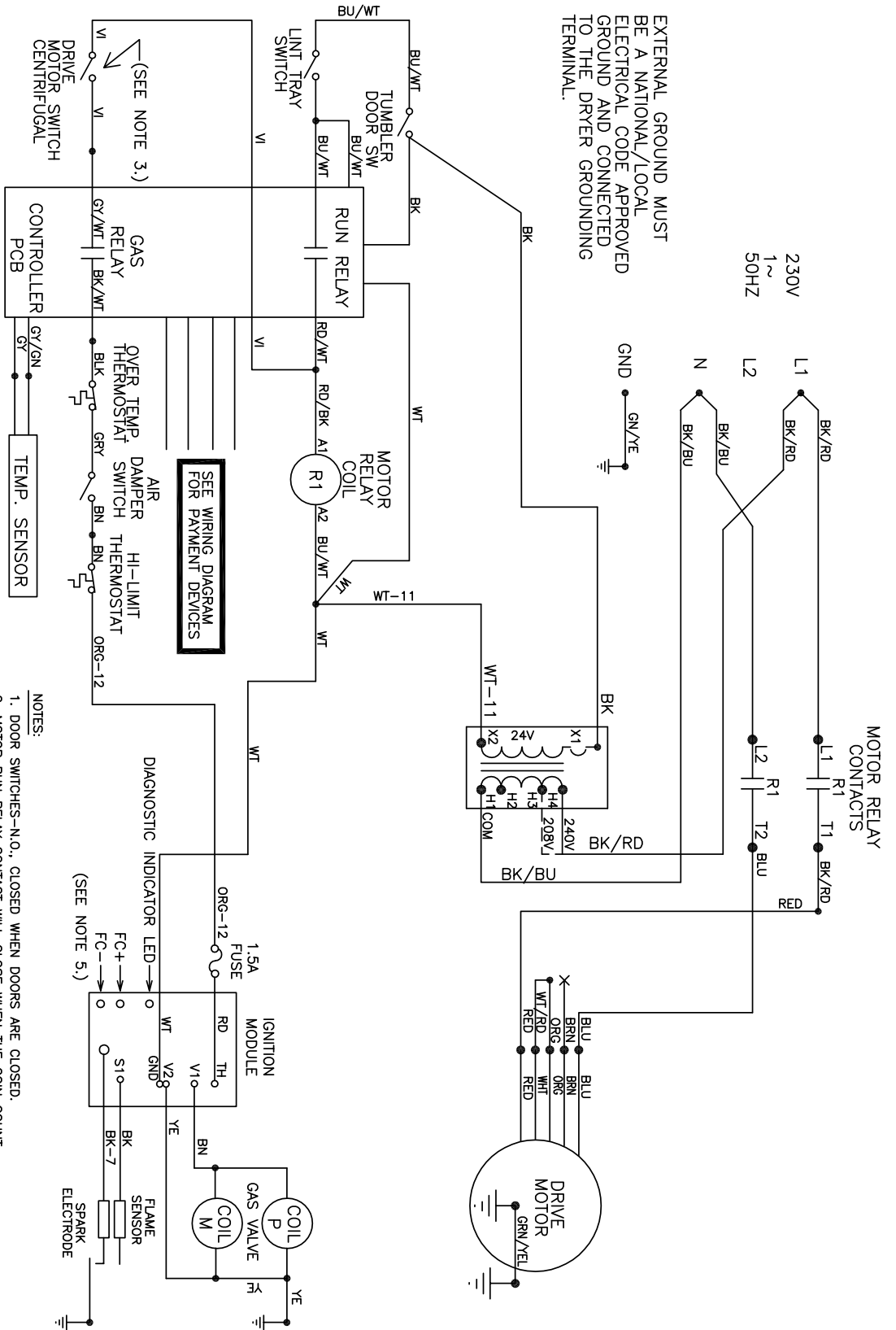

CAUTION: LABEL ALL WIRES PRIOR TO DISCONNECTION WHEN SERVICING CONTROLS. WIRING ERRORS CAN CAUSE IMPROPER AND DANGEROUS OPERATION. VERIFY PROPER OPERATION AFTER SERVICING. ATTENTION: AU MOMENT DE L'ENTRIEN DES COMMANDES, ÉTIQUETEZ TOUS LES FILS AVANT DE LES DÉBRANCHER. DES ERREURS DE CÂBLAGE PEUVENT ENTRAINER UN FONCTIONNEMENT INADÉQUAT ET DANGEREUX. S'ASSURER QUE L'APPAREIL FONCTIONNE ADEQUATEMENT UNE FOIS L'ENTRIEN TERMINÉ.

- NOTES:
1. DOOR SWITCHES--N.O., CLOSED WHEN DOORS ARE CLOSED.
 2. MOTOR RUN RELAY CONTACT WILL CLOSE WHEN THE COIN COUNT IS SATISFIED, THE DOOR CLOSED AND THE START BUTTON PRESSED.
 3. CENTRIFUGAL SWITCH--N.O., CLOSURES WHEN MOTOR IS UP TO SPEED.
 4. REFER TO OWNER'S MANUAL FOR DESCRIPTION OF OPERATION AND REQUIREMENTS FOR HEATING CIRCUIT.
 5. WITH A DC MICROAMMETER, FLAME CURRENT CAN BE MEASURED AT TEST POINTS. READING SHOULD BE 0.7UA DC OR HIGHER.

9506-828-001PR

SCHEMATIC

DCS030N--39_C_X--X

Wiring Diagram for Dryer 50hz 230V -21CR

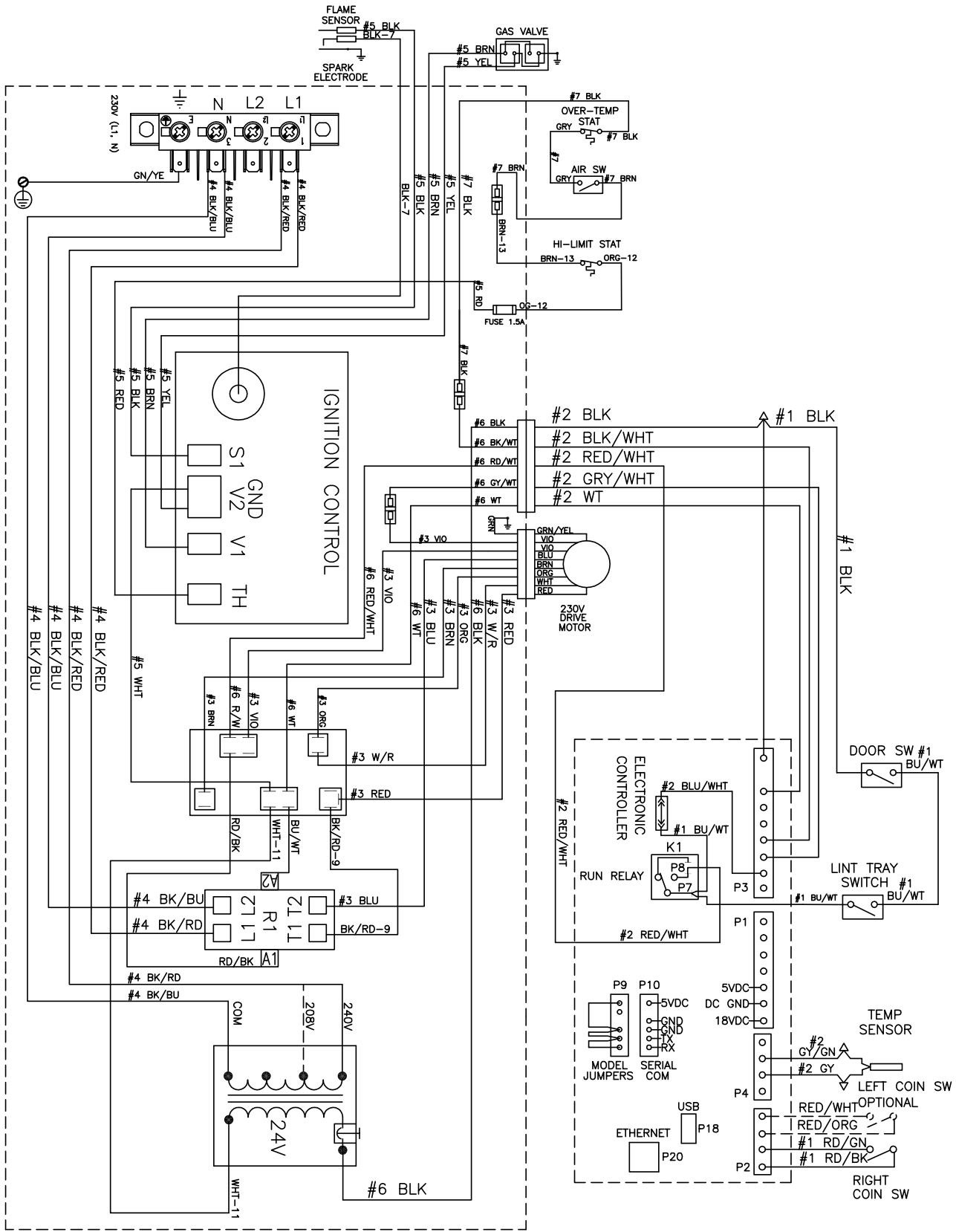

9506-828-001PR WIRING DIAGRAM DCS030N_39_C_X- - - - - X

Section 7:

Washer Service and Trouble Shooting

Electronic Acceptor Coin Drop (Original Design)

Setting the electronic coin acceptor switches

Some washer models come equipped with an electronic coin acceptor. Follow the instructions below for setting the switches for the desired country and currencies.

1. The electronic coin acceptor has switch settings depending on the coins and country. See the table below for available values of the left and right coin inputs for the available countries.

WARNING: turn power off before and leave power off when changing the switches of the electronic coin acceptor.

2. Turn power back on and test coins to ensure proper operation.

Acceptor P/N	Country	Left Coin	Right Coin	SWs 1-8	SWs 9-16
9021-010-001	Canada	25¢		↓↓↑↑↑↑↓	↓↑↑↑↑↑↓
	Canada		\$1	↑↑↓↓↑↑↓	↓↑↑↑↑↑↓
	Canada		\$2	↑↑↑↑↓↓↓	↓↑↑↑↑↑↓
	Japan	100¥		↓↓↑↑↑↑↓	↑↓↑↑↑↑↓
	Japan		500¥	↑↑↓↓↑↓↓	↑↓↑↑↑↑↓
	Taiwan	10NT		↓↓↑↑↑↑↓	↑↑↓↑↑↑↓
	Taiwan		50NT	↑↑↓↓↑↓↓	↑↑↓↑↑↑↓
	Korea	500W		↓↓↑↑↑↑↓	↑↑↑↓↑↑↓
		Greenwald 118-1 Token		↑↑↑↑↑↑↓	↑↑↑↓↑↑↓
		Greenwald 118-5 Token		↑↑↑↑↑↑↓	↑↑↑↑↓↑↓
	U.S.A.	25¢		↓↓↑↑↑↑↓	↑↑↑↑↑↑↓
	U.S.A.		\$1	↑↑↓↓↑↑↓	↑↑↑↑↑↑↓
9021-011-001	Australia	10¢		↓↓↑↑↑↑↓	↑↓↑↑↑↑↓
	Australia	20¢		↑↑↓↓↑↑↓	↑↓↑↑↑↑↓
	Australia		\$1	↑↑↑↑↓↓↓	↑↑↓↑↑↑↓
	Australia		\$2	↑↑↑↑↑↓↓	↓↑↓↑↑↑↓
	New Zealand	10¢		↓↓↑↑↑↑↓	↑↓↑↑↑↑↓
	New Zealand	20¢		↑↑↓↓↑↑↓	↑↓↑↑↑↑↓
	New Zealand		\$1	↑↑↑↑↓↓↓	↑↑↑↓↑↑↓
	New Zealand		\$2	↑↑↑↑↑↓↓	↓↑↓↑↑↑↓
	Hong Kong	\$5		↓↓↓↓↑↑↓	↑↑↑↑↓↑↓
	Hong Kong		\$10	↑↑↑↑↓↓↓	↑↑↑↑↓↑↓
		Greenwald 118-1 Token		↑↑↑↑↑↑↓	↑↑↑↑↓↑↓
		Greenwald 118-5 Token		↑↑↑↑↑↑↓	↑↑↑↑↑↓↓

NOTE: Coins and tokens in the left coin column will result in one pulse to the left coin input.

NOTE: The \$1, 500¥, 50NT, and \$10 coins in the right coin column will result in one pulse to the right coin input, while the \$2 coins will result in two pulses to the right coin input.

NOTE: Acceptance of multiple coins per country and multiple tokens is allowed. Only the down/off setting for each coin and token is required to accept that coin or token.

Maintenance Instructions -Electronic Acceptor (Original Design)

1. Instructions to open the flap of the coin selector

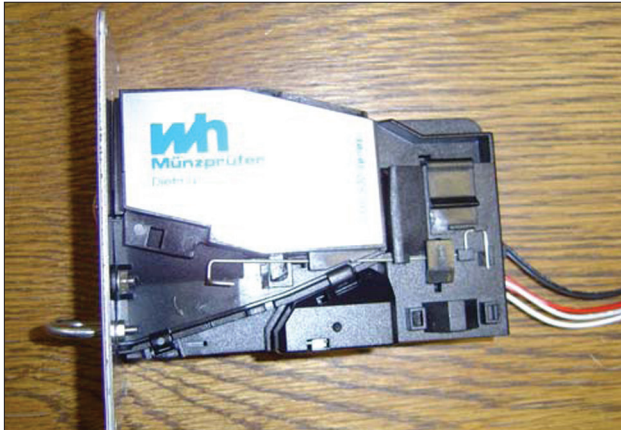

Original situation

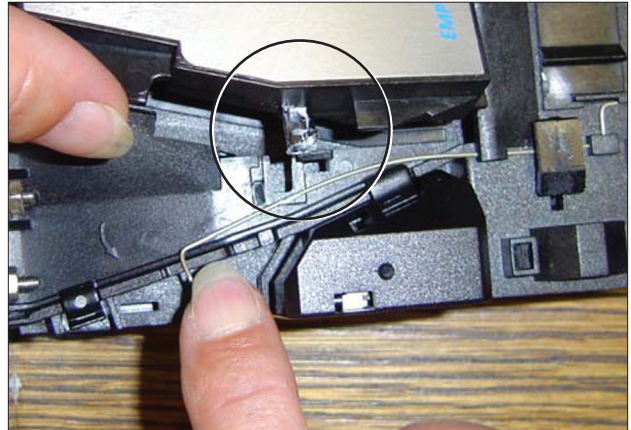

Move spring downwards to free the catch.

NOTE:

- Do not lift the spring
- Do not over bend the spring in any direction.

Open the flap of the coin selector.



2. Assembly instructions to change a spring

Lift the right end of the spring by means of a screw driver.

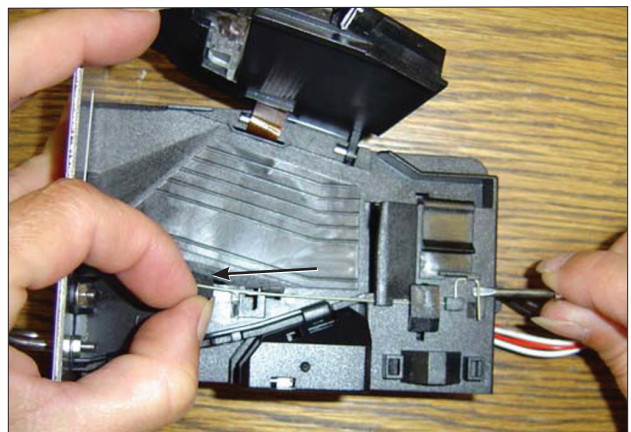
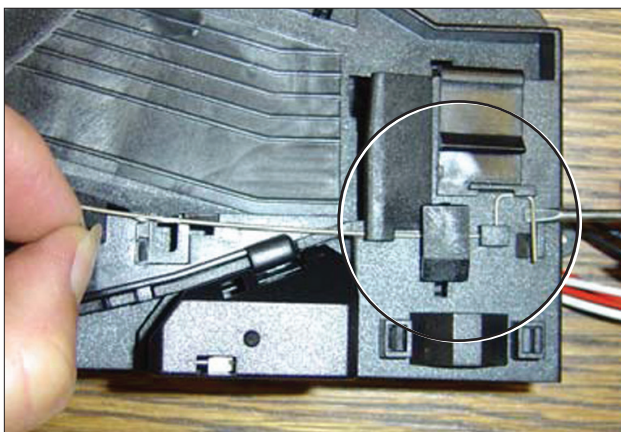

Pull the spring approximately 3 mm to the left.

Maintenance Instructions -Electronic Acceptor (Original Design)

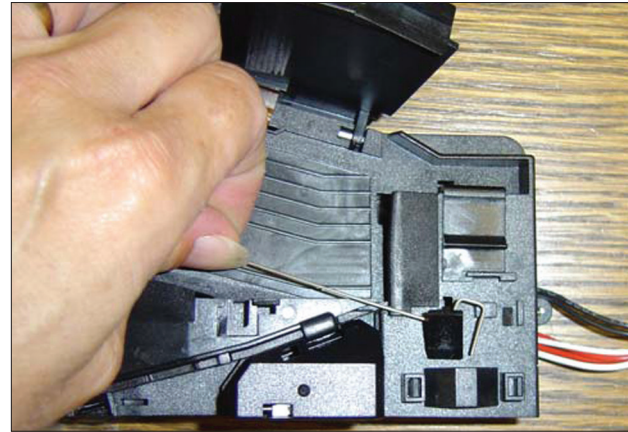
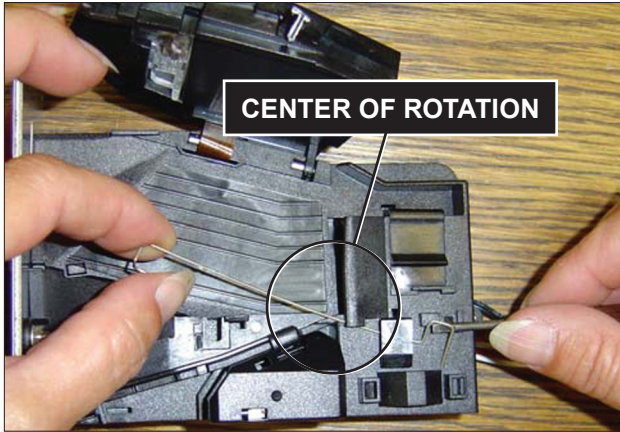

Rotate the spring clockwise for about 40 to 60 degrees until it becomes free of the protrusion. Lift off the spring with the attached plastic part.

3. Assembly of a new spring

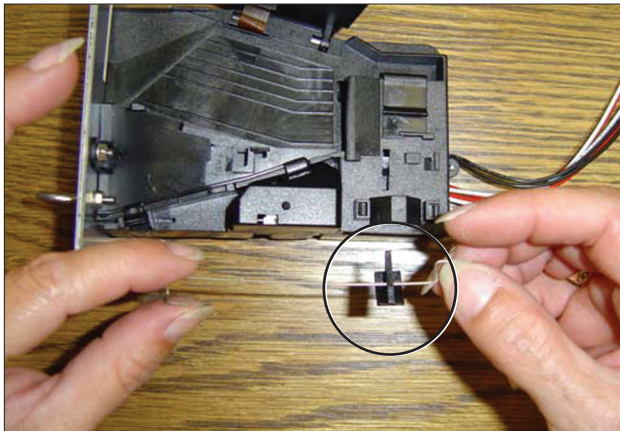

Attach the plastic part to the new spring.

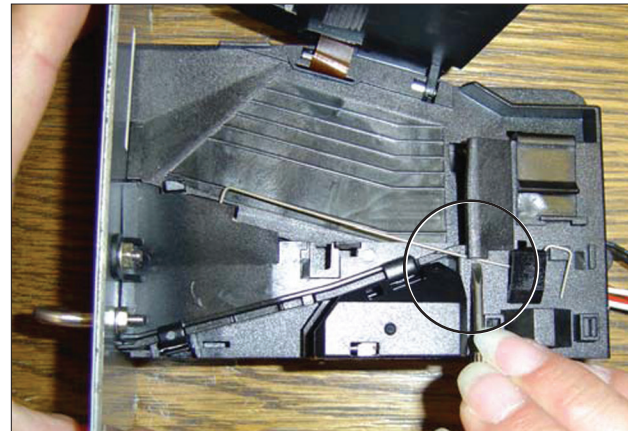

Place the plastic part in its position (slot).

Push the spring below the protrusion by means of a small screw driver.

Push the spring lateral to the right until its snaps

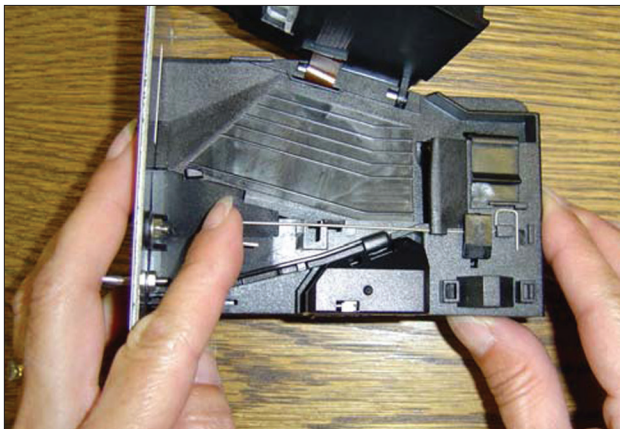

into its proper position.

Maintenance Instructions -Electronic Acceptor (Original Design)

4. Close the coin selector

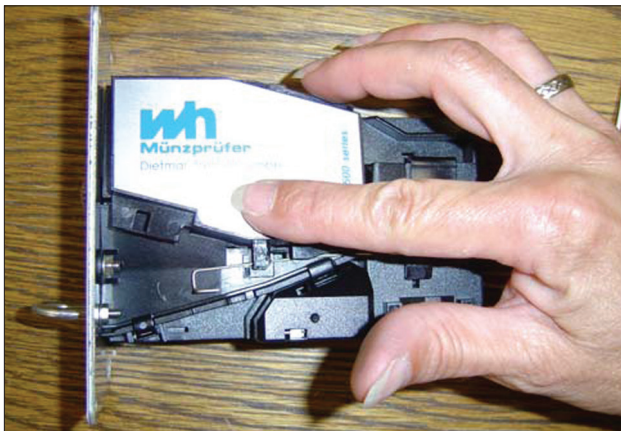

To shut the coin selector follow pictures 1 to 3 in reverse order.

5. Cleaning the electronic coin selector

The EMP 500 v4 is an extraordinarily robust coin selector and operates relatively maintenance free. However, it should be cleaned at regular intervals (minimum once a year) especially if it is operating in an environment with high levels of dust, smoke, or nicotine. The cleaning intervals are of course dependent on the level of air borne contaminants.



Clean the coin path with a soft brush and wipe the exposed surfaces. Use an alcohol moistened cloth.



If you find solid residues stuck to the coin rail (patina) remove it with an alcohol moistened cloth.



Optical sensors may be cleaned with a soft brush or very carefully with an air spray duster.

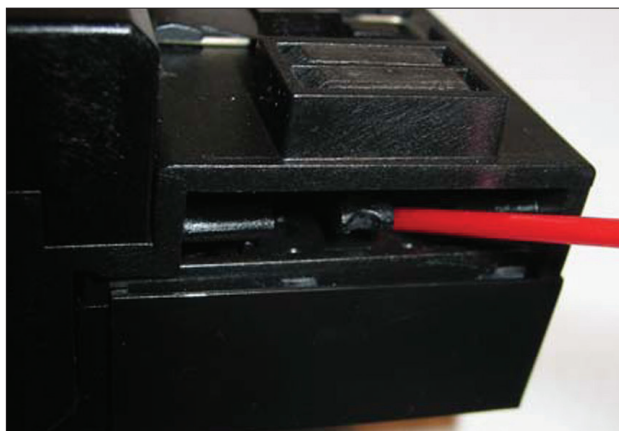

Location of the optical sensor within coin outlet.

Maintenance Instructions -Electronic Acceptor (Original Design)

6. Adding the bolt #4036

A bolt can be added to the EMP 500 v4 to reduce attempts of vandalism or to protect the unit from improper use.

NOTE: that some front plates/cashboxes might not allow mounting this additional device.

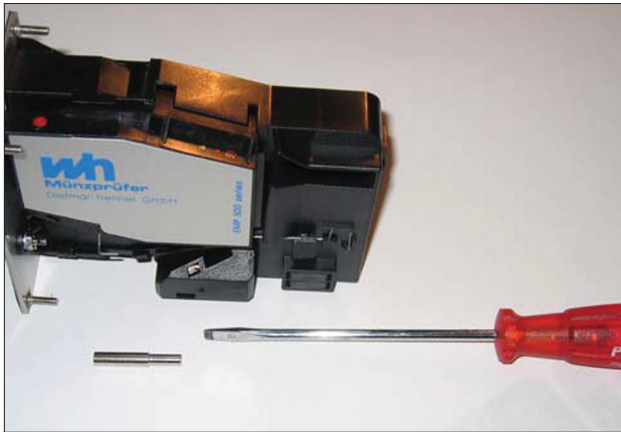

The bolt (part number 4036) should be mounted with the help of a screw driver.



Screw the bolt onto the existing stud weld on top of the nut which fixes the reject bracket.



Once the bolt is fixed, please verify the position of the spring as indicated in the picture.

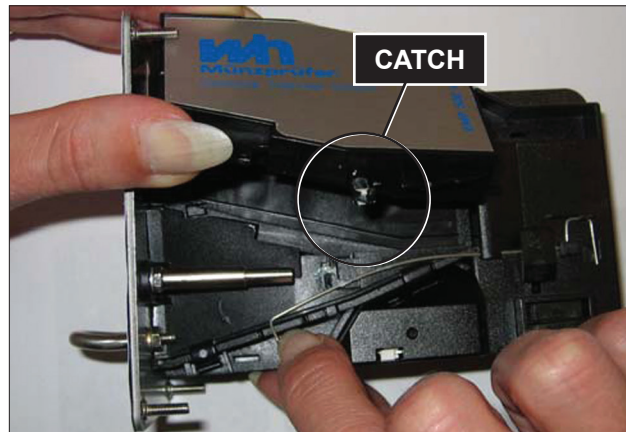

To open the selector move spring downwards to free the catch.

Front Soap Box removal

- Step 1:** Remove front Panel
- Step 2:** Remove the six 3/8 nuts and remove Soap Box mounting bracket and Soap Box, followed by removing gasket.
- Step 3:** Reassemble reverse operation.

NOTE: Be sure to note position of washers and spacers behind mounting bracket.

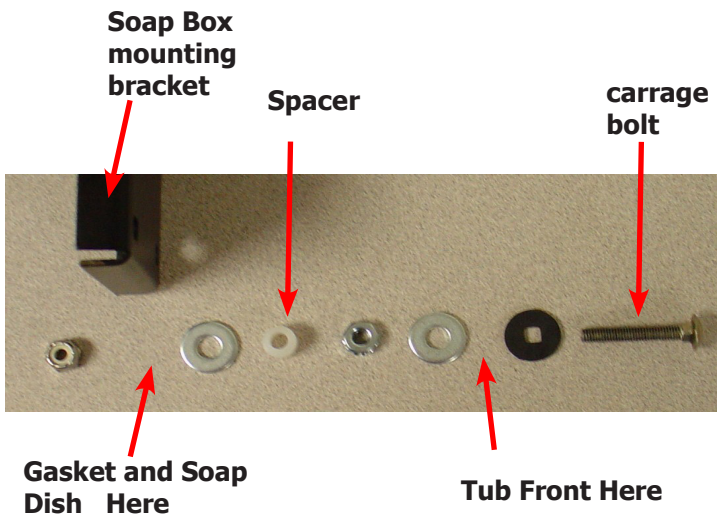

Mechanical Acceptor

Standard Coin Drop Acceptor

The drop style coin acceptor contains a coin switch that is actuated by each good coin that is accepted.

Removal

The coin acceptor is removed by loosening the two Torx T-10 machine screws on the right side and by removing completely the two Torx T-10 machine screws on the left side (#T-10 Torx driver, Dexter Pt. No. 8545-051-003). There are locking nuts on the back side that will have to be held. Needle-nose pliers work well for this. Sliding the acceptor to the left will remove it from the slots in the front panel. This gives access to the coin switch and acceptor for adjustments.

Coin Thickness Adjustment

On the right side of the acceptor there is a coin thickness adjusting screw "A" with a locking nut. To allow for different thickness coins the screw can be turned in to accept thicker coins and turned out to reject thicker coins. Start with a quarter of a turn on this screw and be sure to retighten the lock nut after adjustment.

Coin Height Adjustment

On the left side of the acceptor is a coin height adjusting bar "B". This bar is adjusted by loosening the two mounting screws and moving both ends of the bar up or down equal amounts. The bar should be raised as high as possible while still accepting the correct coins. If it is raised up too high, the good coins will be rejected.

Coin Switch Adjustment

The normally open coin switch "C" should click (close) soon after the coin hits the operator wire. However, there must be enough travel to allow the switch to reset (open) once the coin has passed. Adjustment should be made by bending the wire very close to its attachment point.

Front Panel Removal

- Step 1:** Remove the screws from front panel.
- Step 2:** Remove the harness connections from the control boards on the back of the front panel.
- Step 3:** Pull back the front panel and set it aside.

Back Panel Removal

- Step 1:** Remove all screws holding back panel in position except the bottom row.
- Step 2:** The bottom row of screws are slotted and only need to be loosened and to lift off panel.

NOTE: The back panel is not only a safety requirement but also contributes to the rigidity of the cabinet.

Drain Valve Access

For access to drain valve, remove the front panel. The drain valve is a ball type and is powered closed by the drain valve motor. It is mounted under the washer tub on the left side. It is spring loaded open. If power is interrupted to the washer, the motor releases the sealing ball, allowing the drive spring to open the valve. With the valve open, all water in the washer will drain out.

Drain Valve Cleaning

- Step 1:** Loosen the clamp on the tub hose at the drain valve end and remove the hose from the drain valve.
- Step 2:** Loosen the drain hose clamp on the back of the drain valve. Remove two drain valve mounting bracket screws from the frame of the washer.
- Step 3:** Remove the drain valve and bracket assembly. Unplug the wiring after the drain valve is removed from the washer.

Door Locking Gear Motor Assembly

The door locking gear motor is rotated shut with control voltage to lock the door and releases when voltage is removed. It is located in the left front corner of the washer.

Thermoactuators

The thermoactuators are a safety device that keeps the door from immediately unlocking if power is lost while the machine is operating. They are mounted above the door locking gear motor.

Lock Thermoactuator

Control voltage is applied to the lock thermoactuator at the beginning of the cycle making it extend and block the door locking gear motor. This keeps the door locked for approximately two minutes after a power failure occurs. The lock thermoactuator does not delay the door opening at the end of a normal cycle.

Unlock Thermoactuator

To insure that the lock thermoactuator has retracted by the end of the cycle, one minute prior to the end of the cycle, the unlock thermoactuator is powered with control voltage making it extend and unblock the door locking gear motor.

Drive Belt Removal

Turn the drive pulley while applying pressure to the drive belt until it rolls off of the basket pulley first and then remove from the motor pulley. Be cautious not to drop the motor which could unhook the tension assembly.

Reverse this procedure for installation.

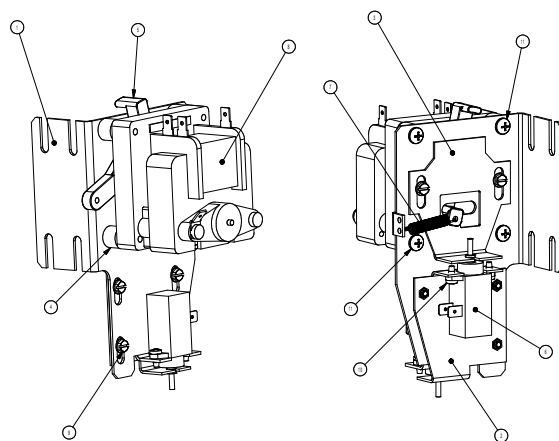

Door Lock Gear Motor

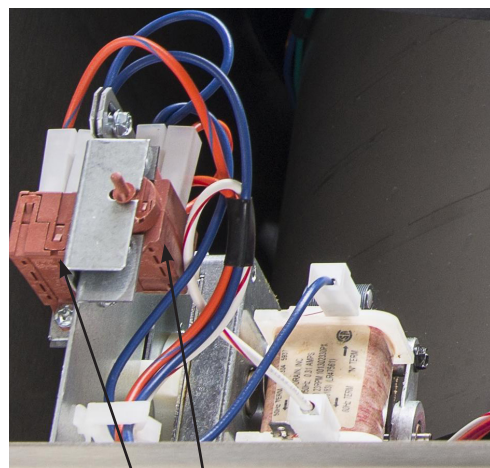

Thermoactuators



Drive Belt

Detergent Dispenser

The detergent dispenser is located at the top of the front panel. It is fed water from the vacuum breaker assembly at the rear of the machine to flush the soap with hot water during the wash bath and the fabric softener with cold water during the rinse bath.

Vacuum Breaker (also called an air gap)

In the left rear of the cabinet is the vacuum breaker. It guides the water to the tub and dispenser and prevents a back flow of water.

Water Valves

Remove panel to access water valves at rear. The two dual outlet water valves are mounted to this plate. Always check inlet screens to be sure that they are clean. Disassembly of valve requires the removal of two solenoid screws and three valve body screws. Inside the solenoid coil is a solenoid guide, armature, armature spring, and diaphragm. All valve parts are available individually or as a complete unit.

Door Lock Assembly Operation

After loading the clothing, the door should be closed and latched. The locking cam on the door contacts the latching switch actuator which closes the latching switch. The specified number of coins should now be added to start the washer. The gear motor pulls up on the locking pawl by use of a linkage rod. The locking pawl has two jobs. The first is to lock the door. This is accomplished by blocking the locking cam on the door so that it can't rotate to unlock. The second job is to close the two piggyback lock sensing switches. These switches control power to all of the controls. If the door unlocks for any reason, these two switches will stop the machine. When the door handle is 1/4 to 1/2 of an inch from its fully closed position, the latching switch should close. The two piggyback lock sensing switches should be open when the door is unlocked and should be closed when the door is locked.

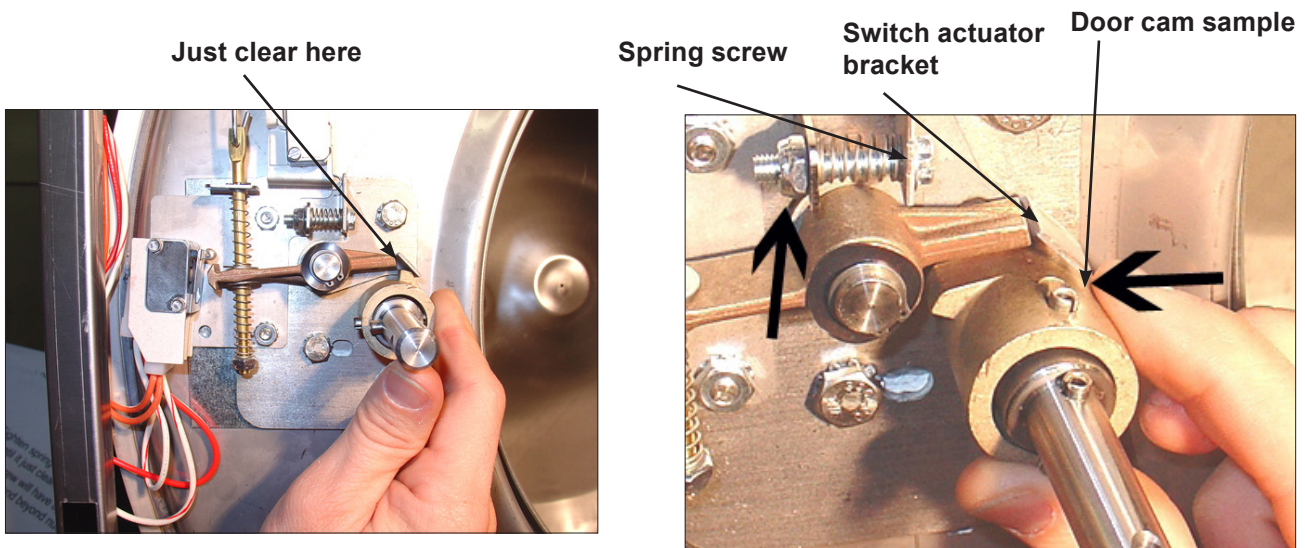

Step 1: Set door cam over pin. Here you can see the door cam away from the door lock assembly.

Step 2: Tighten spring screw on switch actuator bracket arm until it just clears cam OD. at base of door lock assembly.

Adjustment to this bracket usually is not necessary as next step is used more in field.

Flat blade screw on door switch latching

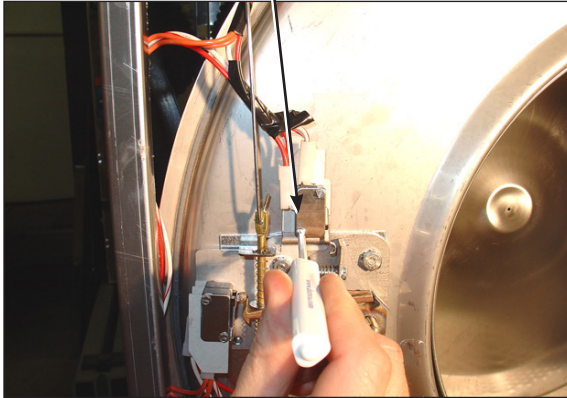

Step 3: With switch actuator bracket adjusted you will now need to adjust single switch by loosening 2 flat blade screws and allowing swivel of switch. Move switch towards above bracket until it actuates. Now tighten flat blade screws. Use a .040 thickness gauge to insert between bracket and switch and the switch should close and open again upon removal of thickness gauge.

Door cam check position

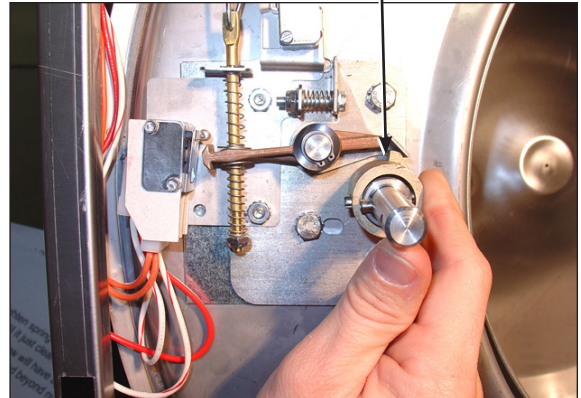

Step 4: Check for switch actuation at partial turn of cam as in operation above. Door handle goes from horizontal to six o'clock vertical.

Door lock rod Locking pawl blocking

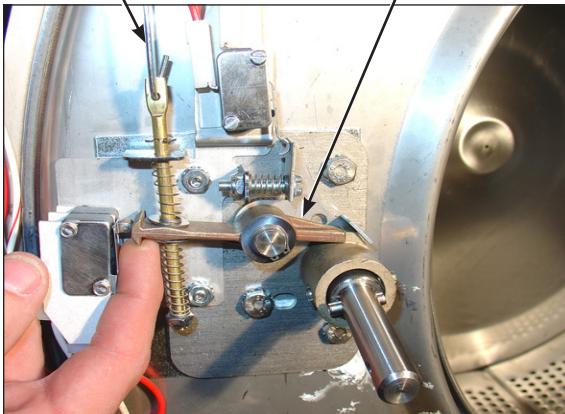

Step 5: Check that lock pawl arm swings to cam lobe to lock position.

Adjustment screw for (piggyback switches)

Top of flat end of locking pawl.

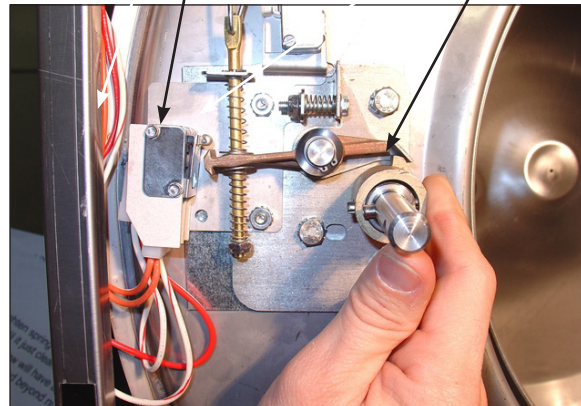

Step 6: The lock stacked switches (piggyback) must be adjusted as door lock gear motor pulls up on door rod and locking pawl is now blocking door cam from turning and is in full up position. The stacked switches (piggyback) have a single actuator arm and it must actuate when single actuator roller wheel rolls to flat side of locking pawl. You will also notice a .040 gap between actuator arm and switch bodies.

NOTE: Both stacked switches must operate together!

Adjusting the Loading Door

The door can be adjusted by changing the number of shims behind the door hinge and the door lock assembly. The vertical fit of the door to the tub can be altered by loosening the door hinge bolts and raising or lowering the door before retightening. It is important for the door to be centered on the tub front. By chalking the front of the tub and closing the door to transfer that line to the gasket, the centering can be evaluated. It is also important for door pressure to be similar around the door perimeter. Door pressure can be evaluated by inserting a dollar bill in several positions and tugging on it. See Parts Section for kit to increase door sealing pressure.

Loading Door Removal



Step 1: Support door to prevent dropping.



Step 2: Remove the bottom 2 bolts holding the lower leaf hinge and then remove it. The door can now be lifted from the upper post of the hinge assembly.

Loading Door Hinge Removal

Step 1: First remove loading door and front panel.

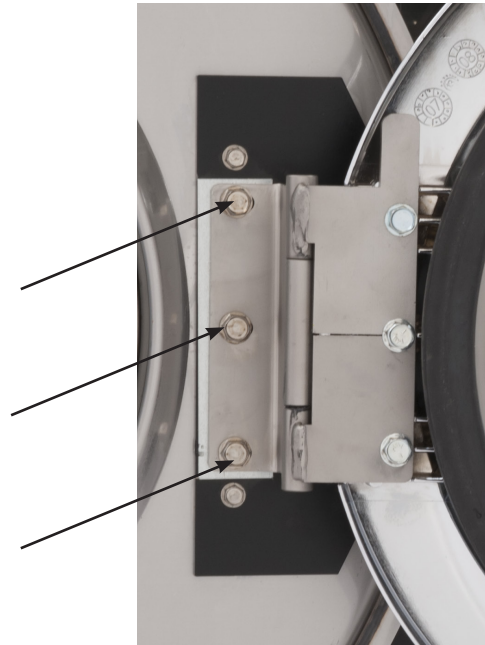

Step 2: Remove 3 screws holding door hinge. Shims may be present between hinge and tub front. The number may be increased or decreased to adjust right side door pressure.

NOTE:
Door hinge mounting bolts penetrate tub front and require silicone sealer applied to holes when reinstalling.

Loading Door Reassembly

Step 1: Lay the door ring face down on a flat surface. Start the glass into one side of the door gasket.

Step 2: Use one hand underneath to push the gasket out and the other hand on the top pulling the gasket in place.

Step 3: The front lip of the door gasket should be checked for proper seating.

Control Panel Name Plate Decal

The name plate on washer front is adhesive backed.

Control Panel Name Plate Removal

The name plate may be removed by simply peeling it off.

Re-Installation of Name Plate

Step 1: Remove any remaining glue from the control panel.

Step 2: Before removing the paper backing from the name plate, check fit to the control panel. The program push buttons are the locating guides.

Step 3: Remove the paper backing from the right side of the name plate, position it on the panel and press right end into place. Peel the backing from the left end and press into place.

Tub Back, Bearing and Cylinder Assembly

Removing the Washer Tub Assembly from the Washer Frame

Step 1: Remove the left and right lower front panel screws that retain the panel to the chassis.

Step 2: Remove the Drain Hose from the bottom of tub assembly.

Step 3: Remove Overflow and Tub vent hoses at rear tub back.

Step 4: Remove the pressure switch hose from the bottom of the switch.

Step 5: Disconnect the door lock wires from all switches and the door lock solenoid. The following illustration of their locations should be consulted.

Step 6: Disconnect pull rod between solenoid and door lock assembly.

Step 7: Disconnect the wires to the drain valve at the bottom of the machine.

Step 8: Remove 4 (four) bolts at outer tub and slide complete assembly out front . (Note: very heavy, use appropriate devices)

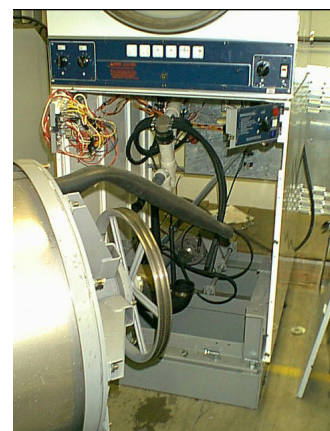

Tub Back, Bearing, and Cylinder Assembly

Removal

- Step 1:** Remove the tub and cylinder as described previously
- Step 2:** Remove the overflow hose, tub fill hose, and pressure switch hose from the back of the tub.
- Step 3:** Mark the tub back and bearing assembly for ease in assembly later. (see picture)
- Step 4:** Remove the 12 bolts and nuts from the perimeter of the tub back clamp ring. (Two of the twelve bolts are longer and go through the thicker part of the brace where it connects to the frame.)
- Step 5:** Remove the 2 bolts that fasten the clamp ring to the frame.
- Step 6:** The entire tub back and cylinder assembly may be lifted out of the tub (it may be necessary to break the adhesion of the silicone that seals the tub back to the tub). Blocks should be placed under the edges of the cylinder before setting it down to prevent damage to the cylinder flange.

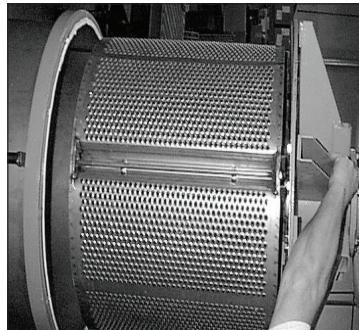

Reassembly

Reverse the procedures to the left paying attention to the following areas

- Step 1:** Lay the tub and cylinder on its front. **NOTE:** Put a thick pad across the front of the washer, above the door, to protect the tub front
- Step 2:** Make sure the bearing housing weep holes are located at 12 o'clock and 6 o'clock.
- Step 3:** Clean the silicone rubber from the back of the outer tub and the perimeter of the tub back where the two meet. There is no gasket in this area.
- Step 4:** Apply a new bead of silicone rubber around the back of the outer tub. (see picture)
- Step 5:** Lower the tub back, bearing and cylinder assembly into the washer outer tub.
- Step 6:** Torque all bolts according to the following charts.
- Step 7:** Use a puller to remove the pulley from the shaft.

Basket Pulley, Bearing Housing, Water Seals, and Tub Back

The cast iron basket pulley is retained by a bolt, locking washer, and a flat washer.

Removal

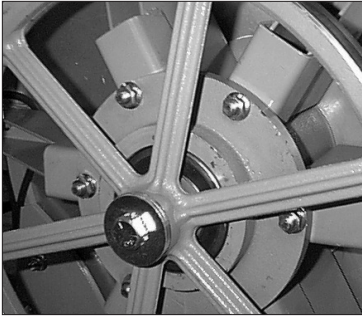

- Step 1:** Insert a large screw driver or punch through a spoke in the pulley into the bearing housing support. This keeps the pulley from turning.
- Step 2:** Remove the retaining bolt, lockwasher, and flat washer and reinstall just the bolt
- Step 3:** Use a puller to remove the pulley from the shaft. Watch for tolerance ring.

Reassembly

- Step 1:** Make sure that the tolerance ring is in place inside the pulley.
- Step 2:** The shoulder inside the pulley that holds the tolerance ring should face the back of the washer when installed correctly.
- Step 3:** Use a stack of flat washers and a longer bolt to press the pulley onto the basket shaft.
- Step 4:** Reinstall the retaining bolt, lock washer and, flat washer. The shaft end bolt with washer should be installed with a torque value listed in charts in this manual.

Removal of Bearing Housing From Basket Shaft, Bearings, and Water Seals



- Step 1:** To remove the tub back assembly, the 6 bolts attaching it to the bearing housing must be removed.
- Step 2:** Remove water seals from the seal mounting plate on the cylinder shaft. These are removed with your fingers.
- Step 3:** The retaining ring next to the front bearing must also be removed.
- Step 4:** The bearings are pressed into the housing and must be pressed back out.

Reinstallation onto Basket Shaft

- Step 1:** Carefully set the assembly over the shaft engaging the bearings and bearing spacer.
- Step 2:** The tolerance ring that fits inside the pulley should be placed in position (see Basket Pulley Reassembly for correct positioning).
- Step 3:** The pulley should then be started onto the shaft. A stack of flat washers and a longer pulley bolt will be required to pull the basket shaft through the bearings and pulley.
- Step 4:** Install the shaft end bolt with washers and torque to specifications in Bolt Torque Chart.
- Step 5:** See Tub Back, Bearing and Cylinder Assembly for installation of complete assembly back into washer.

Reassembly

Step 1: When installing new bearings into a bearing housing, first press the front (large) bearing into the housing until it bottoms. With the bearing spacer in place, press the rear bearing in until the spacer is snug between the two bearings. Be sure and reinstall the retaining ring in front of the front bearing (see picture).

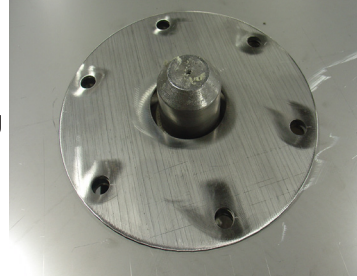

Step 2: The tub back assembly should be reattached to the bearing housing with the 6 mounting bolts and torqued according to the torque chart.

NOTE: The bead of silicone that seals each bolt to the tub back. This must be cleaned and replaced upon reassembly (see picture).

If the 6 support assemblies have been removed from the bearing housing, the 6 rear bearing housing bolts should be torqued according to the chart also.

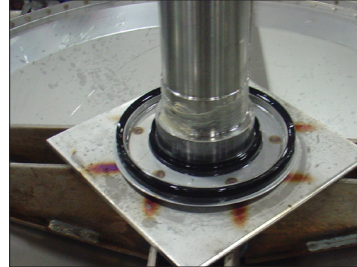

Step 3: The primary and secondary seals that mount on the sealing ring may be slid over the shaft and seated on the metal sealing ring. In the unlikely event that the metal ring that mounts these sealing rings were to be damaged or moved, a new one would need to be pressed on the ring must be pushed against the stop on the shaft. Before installing the new sealing ring, a bead of silicone should be put on the basket shaft (see picture). After installing the seals, lubricate the faces of the seals with silicone grease (see picture).

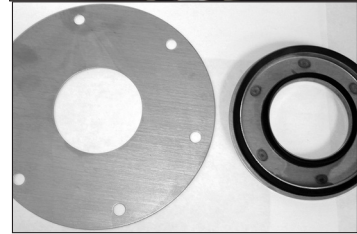

Removal

Step 1: Remove the drive belt as explained in previous instructions.

Step 2: Remove the tension spring and bracket.

Step 3: Disconnect the motor wires in the control area at the top of the machine. The motor wire retaining clamp should be removed and reused. There is a diagram showing where each motor wire plugs in so there is no need to mark them.

Step 4: Loosen the set screws on the motor support shaft.

Step 5: Remove the retaining bolt from the front of the support shaft.

Step 6: Remove the motor support shaft.

Step 7: Lift motor out of machine. **NOTE:** On larger washers it is advisable to put a board under the motor and slide it out rather than lifting it.

Bolt Torque Chart

Bolt Size	Where Used	Torque
1/2"x 1 1/4" bolt	Tub End of Bearing Hsing. 9545-017-009	70-110 ft/lbs
5/8"x 1 1/2" bolt	Tub End of Bearing Hsing. 9545-060-001	120-150 ft/lbs
1/2"x 1 1/4" bolt	Mtg. of Tub to Cradle Asy. 9545-017-009	70-110 ft/lbs
5/8"x 2 1/2" bolt	Mtg. of Tub to Cradle Asy. 9545-060-001	120-150 ft/lbs
3/8"x 1 1/2" bolt	Tub Back Ring to Tub Back 9545-029-003	45-80 ft/lbs

Control Mounting Trough

Remove rear panel to access control trough. It sets on the right side of the machine and holds the control PCB's, transformers, and pressure switch.

Main Data Communication Cable

Goes between front PCB board and Variable Frequency Drive unit mounted center rear of machine. It has telephone type connectors at each end and is inserted at Controller PCB and the Variable Frequency Drive.

Circuit Breaker/Fuse

The fuse (optional circuit breaker) mounts to the rear channel. It carries all of the controls in the machine but does not include the motor and VFD. To reset the circuit breaker just push in the button. If you have a fuse then remove fuseholder and fuse and replace with a 1.5 amp fast blow type fuse.

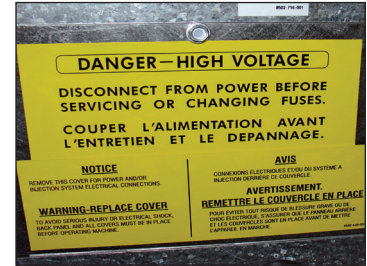

Fuse Location

Main Control Printed Circuit Board

Please be sure to be grounded to machine before removal of this board from machine. PC board mounted behind front control panel. Remove hold down nuts in 4 corners and 1 at bottom center.

Controls Transformer

This transformer is mounted at the back of the control trough and steps a range of 208 to 240 volts down to 24 volts for the controls. There are two terminals on the controls transformer for incoming power. One terminal tap is marked for 208 volts use this tap for measured voltage of 200 volts - 215 volts. and the other tap is marked 230 volts for 216 volts - 240 volts.

NOTE: All washers have a controls transformer. Always check the incoming voltage and use the appropriate transformer terminal when installing ALL washers.

Main Relay Printed Circuit Board

Please be sure to be grounded to machine before removal of this board. PCB mounting in control trough towards top left of control trough. Remove 4 mounting nuts.

Emergency Stop Button Switch Assembly

The stop button is mounted on right side of machine. Remove the top and access the rear of button. Remove the plastic retainer by unthreading CCW. The switch assembly will have to be removed by pressing down on the plastic clip while pulling the switch body away from the stop button.



Temperature and Start Display

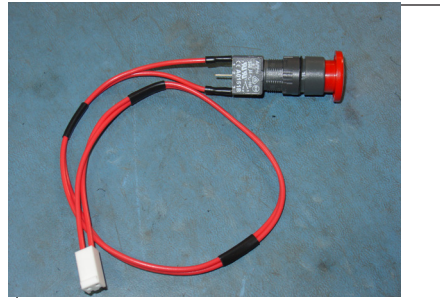

Stop Button Switch Assembly

Power Connection Terminal Block

This terminal block sets at the very back of the machine. Incoming power to the washer should connect here. (see Electrical under Installation and Operation Section for exact connections)

Electronic Pressure Sensor

The Electronic Pressure Sensor comes standard on all models Starting September, 1st 2015. Machines manufactured before this date can be upgraded with Kit 9732-314-001. The Pressure sensor is adjustable. The Factory settings chart will let you know the starting values for each machine and by following the Switch position chart you can adjust the water levels in 1/4 inch increments from that starting value.

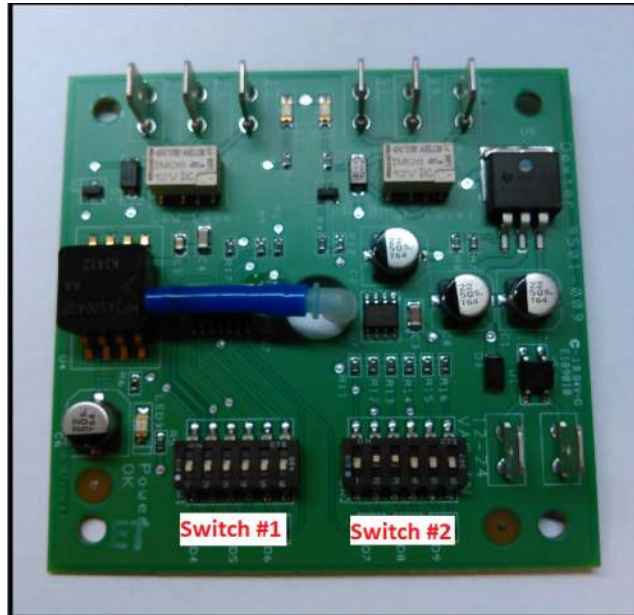

Model	Vended		On-Premise	
	Switch #1 Efficient	Switch #2 Classic	Switch #1 Low Level	Switch #2 High Level
T-300	5.25	7.00	6.00	6.75
T-350	5.25	6.25	6.00	6.75
T-400	7.00	9.00	8.00	11.00
T-450	6.00	6.25	6.00	8.50
T-450 SWD	5.00	7.00	6.00	8.50
T-600	7.25	9.25	8.00	11.00
T-650	6.50	8.25	8.00	11.00
T-750	6.00	7.50	6.00	8.75
T-900	6.00	7.50	6.00	8.75
T-950	6.00	7.50	6.00	8.75
T-1200	6.00	7.50	6.00	8.75
T-1450	6.75	7.00	6.75	9.50

NOTES

Switch Positions:

Depth (in):	Pos 1	Pos 2	Pos 3	Pos 4	Pos 5	Pos 6
5.00						
5.25	on					
5.50		on				
5.75	on	on				
6.00			on			
6.25	on		on			
6.50		on	on			
6.75	on	on	on			
7.00				on		
7.25	on			on		
7.50		on		on		
7.75	on	on		on		
8.00			on	on		
8.25	on		on	on		
8.50		on	on	on		
8.75	on	on	on	on		
9.00					on	
9.25	on				on	
9.50		on			on	
9.75	on	on			on	
10.00			on		on	
10.25	on		on		on	
10.50		on	on		on	
10.75	on	on	on		on	
11.00				on	on	
11.25	on			on	on	
11.50		on		on	on	
11.75	on	on		on	on	
12.00			on	on	on	
12.25	on		on	on	on	
12.50		on	on	on	on	
12.75	on	on	on	on	on	
13.00						on
13.25	on					on
13.50		on				on
13.75	on	on				on
14.00			on			on
14.25	on		on			on
14.50		on	on			on
14.75	on	on	on			on
15.00				on		on

Delta Variable Frequency Drive:

Main power is connected to terminals L1, L2, and L3 on the Delta drive. If the washer is connected to a three phase source, there should be voltage present on all three terminals. If the washer is connected to single phase power, there should be voltage present on terminals L1 and L2.

The voltage should measure 208 Volts to 240 Volts A.C. between phases. There is a tolerance of + 10% on the mains voltage (187 Volts to 264 Volts).

Delta VFD Motor Leads:

The wires from the motor are connected to terminals T1, T2, and T3. Since this drive uses pulse width modulation, an accurate current or voltage reading is not possible. Although an accurate current reading is not possible, a balanced current reading should be present while the motor is running.

Delta VFD Dynamic Braking Resistors:

Two 160 Ohm braking resistors are connected in parallel and attached to the drive at terminals B1 and B2. These resistors allow voltage, which is generated by the motor when decelerating, to be dissipated. They will become hot while the motor is slowing down, so care should be taken so as not to come in contact with them. This will prevent an electrical shock and/or a physical burn.

Delta VFD Cooling Fan:

There is a cooling fan attached to the bottom of the Delta drive. This fan will operate when the internal temperature of the drive reaches a predetermined level, the same way the radiator fan in a newer car operates. **THE FAN CAN OPERATE ANYTIME POWER IS APPLIED TO THE DRIVE!** Remove power to the drive if work is required around the fan.

Common Washer Troubleshooting Solutions

Symptom	Probable Cause	Suggested Remedy
Machine does start	Power Supply	Check these areas: Circuit breakers, Voltage, Power leads, Power connections. Is front display LED showing a dollar amount.
	Door Switch	Check for continuity through door switch when door is closed. If no continuity, adjust or replace door switch.
	Control Breaker Or Fuse	Check 1.5 amp breaker or fuse for continuity. If no continuity, replace breaker or fuse.
	Control Transformer	Check voltage output from control transformer for 24VAC. If voltage is incorrect, replace transformer.
	Coin Acceptor	Check coin switch to make sure coins trip switch and give continuity across switch when closed. If no continuity, adjust or replace switch.
	Check PCB Board	Check all wire connections for sure contacts.
	Check Wiring Between PCB	Check data cable phone type connectors unplug and VFD and replug with power removed.
	Check Relay PCB	Check all wire connections for sure contact.
	Check Door Gear Motor	Check that 24VAC power is at Gear Motor after start button is pushed.
Machine will not accept and count coins	Coin Acceptor	Check coin acceptor switch for any type of blockage or damage. Clean, adjust, or replace the acceptor.
	Power Supply	Check these areas: Circuit breakers, Voltage, Power leads, Power connection
	Door Closed Safety Switch	Check door closed switch at door hinge for proper operation.
	Door Handle Closed Switch	Check single door closed switch at left side of door handle to close when handle is vertical.
	Control Breaker Or Fuse	Check 1.5 amp breaker or fuse for continuity. If no continuity, replace breaker.
	Main PCB	Replace
Door does not lock	Check Display For Fault Code	Does "DOOR LOCK ERROR" show on the front of display. If yes follow tests described in fault code section.
	Door Locking Gear Motor	Check to insure that gear motor is receiving 24VAC from main relay PCB. If it is, replace gear motor.
	Door Switch	Check for continuity through door latch switch when door closed. If no continuity, adjust or replace door switch.
Door will not open	Thermoactuator	Check to see if thermoactuator(s) and/or its mechanism is stuck or binding and not allowing the door lock gear motor to open. Check to be sure that the locking thermoactuator is not receiving 24VAC during the last 1 1/2 minutes of the cycle. Also check to see that the unlocking thermoactuator is receiving 24VAC during the last minute of the cycle. If the thermoactuators do not receive voltage at the correct times, change the PCB. If the timing and voltage are correct, replace the thermoactuator.

Symptom	Probable Cause	Suggested Remedy
Door will not open	Door Rod	Check to see that door rod from gear motor to lock assemble is long enough to allow lock assemble to disengage. If not, adjust rod.
	Door Lock Gear Motor	Check that door lock gear motor is not stuck closed. If stuck, replace gear motor.
No hot water in detergent dispenser	Water Valve Coil	Check coil continuity at terminals and replace if no continuity. 24 VAC power only on for 20 second in wash bath.
	Water Inlet	Check water inlet screens for blockage and clean screens if necessary.
	Water	Check to insure that water is turned on and operating.
	P-20 Wire Harness	Check black & white harness.
Hot water does not enter tub in wash	Water Valve Coil	Check coil continuity at terminals and replace if no continuity. Check for 24 VAC power from main relay PCB
	Water Inlet	Check water inlet screens for blockage and clean if necessary screens
	Water	Check to insure that water is turned on and operating.
	Black Or White Wire At Main Controller	Check black or white wires at Molex plug on PCB at main controller and at relay PCB.
	Pressure Switch	Check pressure switch continuity between terminals . If no continuity, check pressure switch hose for obstruction. If hose okay, change pressure switch.
No cold water to tub in wash	Water Valve Coil	Check coil continuity at terminals and replace if no continuity.
	Water Inlet Screens	Check water inlet screens for blockage and clean if necessary.
	Water	Check to insure that water is turned on and operating.
	Black Or White Wire At Controller And Main Relay PCB	Check black or white wires at Molex plug on PCB at main controller and at relay PCB.
	Pressure Switch	Check pressure switch continuity between terminal contacts. If no continuity, check pressure switch hose for obstruction. If hose okay, change pressure switch.
Water comes in but level does not rise	Drain Valve (Open)	Check these areas • Drain valve blockage • Drain valve motor and gear train. If power but drain valve does not close, replace valve. • Power to the drain valve. If no power to drain valve, check (brown/yellow) circuit for power.
	Black Or White Wire At Controller	Check black and white wires at molex plug on main PCB controller and at main relay PCB
Water does not flush softener compartment.	Water Valve Coil	Check coil continuity at terminals and replace if no continuity.
	Water Inlet Screens	Check water inlet screens for blockage and clean if necessary.
	Water	Check to insure that water is turned on and operating.

Common Washer Troubleshooting Solutions

Symptom	Probable Cause	Suggested Remedy
Water does not flush softener compartment.	Pressure Switch	Check pressure switch continuity between terminals. If no continuity, check pressure switch hose for obstruction. If hose okay, change pressure switch.
Water level too high	Pressure Switch	Check for blockage in pressure switch hose. Check for pressure switch opening circuit across terminals. Replace switch if contacts do not open.
Water drains slowly	Drain System	Check hoses and drain valve for blockage. Clean if necessary. Check building drains for blockage
Machine does not turn	VFD	Check VFD by removing inspection panel and record any numbers or letters displayed. If no display turn power off to machine at breaker for 2 minutes and turn power back on to reset. If still no display replace VFD.
Machine tumbles in one direction	VFD	Remove inspection cover at rear and record in only numbers or letters displayed. See fault code section for more info.
	VFD	Inspect yellow enable wires from main relay PCB and at VFD
Excessive vibration	Mounting System	Check these areas: • Strength of mounting structure, concrete, or base. • Mounting bolts may be loose and need tightening.
	Drive Belt	Worn drive belt can cause vibration and noise.
	Loading	NOTE: Small loads contribute to out of balance loading and increase vibration.
Machine does not spin	Pressure Switch	Check pressure switch for continuity across terminals #21 & #22 indicating pressure switch has reset to the empty position. If no continuity, change pressure switch.
Machine starts and does not operate	VFD	Check yellow enable wires from relay PCB P13 & motor P14 to VFD advances through cycle are connected. Check fault code on VFD before removing power from the drive. Check orange P-15 wire for signal from door switches.
Machine does not stop	Main PCB	Main PCB controls time cycle at end of cycle
	Braking Resistors	Check braking resistors for continuity. Verify ohms resistance by Molex.
Water leakage around loading door	Door Adjustment	Door may need adjustment due to abuse or wear. Check tightness around perimeter using a dollar bill. Adjust left to right tightness by shims at door lock or hinge side. It is important to center gasket to tub opening before tightening door to hinge bolts. Chalk may be used on tub front to show point of contact with tub. If gasket is deformed, worn, or damaged, replace. Refer to parts section for door gasket expander kit.

Troubleshooting Machine Fault Errors

Displayed on front of washer

The following pages are a description of fault codes that will appear on the front of the washer. There is a chart format that shows what fault code that will be displayed at washer front. These codes displayed may stop machine operation or may not stop machine Please check chart before removing power to reset. **PLEASE NOTE: CHECK DRIVE FAULT CODE BEFORE POWERING MACHINE DOWN!**

Fault	Description	Customer Action	
DOOR LOCK ERROR	The Door Failed To Close And Lock Or The Door Failed To Remain Locked During The Cycle.	Condition	This error is when the Door Locked signal is not received within one second after the start of the cycle. After three attempts to start the washer.
		Delay	Immediate
		Action	When the error occurs, the Door Lock Gear Motor will be turned off; all other outputs will be turned off.
		Solution	Check VFD fault light. Check to hear if door motor engaged. Turn off the power to the washer. Check wire connections to door/lock switches. Check wire connections from switches to controller. Check P-4 Door/Lock wire connections at PCB controller. Adjust the door lock mechanism. (See online service manual or video)
SLOW FILL ERROR	Slow Fill Error	Condition	This error is when the water level is not reach within 7 minutes.
		Delay	Immediate
		Action	The washer cycle will continue
		Solution	Turn off the power to the washer. Check the operation of the water valves. Check the incoming water pressure. Check for blocked or restricted water flow. Check to ensure the drain valve is functioning properly.
MEMORY ERROR	Checksum Or Out Of Range Error	Condition	Memory error in the controller. The memory checksum is wrong or a parameter value is out of range.
		Delay	Immediate
		Action	Stop the washer and turn off all the outputs.
		Solution	Check VFD fault light before turning off power. Try a soft Reset of the controller with the white button. If problem persist replace PCB controller.

Fault	Description	Customer Action	
COMM ERROR 1	I2C Bus Error	Condition	Washer controller communication error on the I2C bus. Both the main slave micro and the master micro can be in this error state. The slave micro error is recoverable at any time, if I2C communication resumes. The master micro error is permanent.
		Delay	The main slave starts displaying this error after 6 seconds of no (valid) I2C activity. The master micro goes into this permanent error state after 8 seconds of no (valid) I2C activity
		Action	Stop the washer and turn off all outputs.
		Solution	Check VFD fault light before turning off power. Try the data cable first. Move around cable and remove any side loading tension from data cable connector ends. Check connection P23 to P15. Turn power back on to the washer. If the problem returns, replace the PCB washer controller.
COMM ERROR 2	Wrong Washer Size Jumper Configuration	Condition	Invalid washer size jumper (harness) configuration.
		Delay	Immediate (after the wrong size jumper configuration is read). Washer size/type inputs are read only at power up, before starting a cycle, once every 24 hours, and in factory test mode.
		Action	Stop the washer.
		Solution	Check VFD fault light before turning off power. If the controller was installed in a different size machine before being installed in this machine, a problem can occur. If someone has been doing repairs on the washer, check for the correct size drive. It can also be caused by pressure switch harness. Check to ensure the correct harness is installed. The control can be reset by holding program button on controller during startup (soft reset). Check orange wire at Molex connector on controller coming from pressure switch or replace pressure switch harness.
COMM ERROR 3	Washer Size Or Type Changed	Condition	The washer size or washer type configuration has changed.
		Delay	Immediate (after the size jumper configuration is read). Washer size/type inputs are read only at power up, before starting a cycle, once every 24 hours, and in factory test mode.
		Action	Stop the washer.
		Solution	Check VFD fault light before turning off power. Check to ensure all the harnesses are properly connected to the controller. Check to ensure the VFD drive horsepower is proper for this size of washer. The control can be reset by holding program button on controller during startup (soft reset). Check orange wires at Molex connector on controller coming from pressure switch.

Fault	Description	Customer Action	
COMM ERROR 4	VFD Non Existent Or Communication Fault	Condition	This error is when the washer controller cannot communicate with the drive.
		Delay	Delay time is 2 seconds
		Action	Stop the machine and clear the cycle. Keep the door locked until the machine has stopped moving and then unlock the door.
		Solution	<p>Check the data communication cable between the washer computer and the variable frequency drive (VFD).</p> <p>Step 1: Make sure the cable did not become unplugged during operation.</p> <p>Step 2: Make sure that the cable is not being pulled sideways at either the washer controller, or the VFD, plug end. If both ends of the communications cable are plugged in the washer computer and VFD and there is no tension on the communications cable pulling it from side to side, then replace the cable.</p> <p>Step 3: Inspect both female connection points at PCB controller and at VFD. These may need replacement if they cannot be reset.</p>
COMM ERROR 5	VFD Communication Fault	Condition	This error is a data error on communications between the controller and the VF drive
		Delay	Delay time is 12 seconds.
		Action	Stop the machine and clear the cycle. Keep the door locked until the machine has stopped moving and then unlock the door.
		Solution	<p>The CE errors are communications errors. Data Cable noise can cause the majority of these errors. Check VFD fault light before turning off power. Check the data cable between the controller and the drive. Replace data cable if it appears damaged and fault appears again. Please note that this fault will occur if you turned main power off and on to quickly.</p>
COMM ERROR 6	VFD Communication Fault	Condition	This error indicates that a VFD exception error is set
		Delay	Occurs following the "DELAY" error (see corresponding detail)
		Action	Stop the machine and clear the cycle. Keep the door locked until the machine has stopped moving and then unlock the door.
		Solution	The washer will not restart until the power is removed and re-applied.

Troubleshooting Machine Fault Errors

Fault	Description	Customer Action	
COMM ERROR 7	Communication Bus Error	Condition	If a state-of-health message reply is not seen by the master microprocessor from the UC3 microprocessor after 10 minutes, the master will reset the UC3 and restart the 10 minute timer. Again, after 10 minutes, if a state-of-health message is not received by the master, it will reset the UC3 a second time. After 10 minutes, the master will reset the UC3 a final time and post a COMM ERROR 7. NOTE: When the master resets the UC3, the control will disconnect from the network. If the first reset is not successful, the control will not be able to reconnect to the network, USB or card reader functions.
		Delay	3 cycles of 10 minutes (see above)
		Action	Stop the machine and clear the cycle. Keep the door locked until the machine has stopped moving and then unlock the door.
		Solution	The washer will not restart until the power is removed and re-applied.
COMM ERROR 8	VFD Communication Fault	Condition	This error is caused when the VFD reports a frequency value that is out of range
		Delay	Delay time is 35 seconds
		Action	Stop the machine and clear the cycle. Keep the door locked until the machine has stopped moving and then unlock the door.
		Solution	The washer will not restart until the power is removed and re-applied.
PCB ERROR1	Controller Internal Fault	Condition	This error is an internal failure of the washer controller electronics.
		Delay	Immediate
		Action	Stop the machine and clear the cycle. Keep the door locked until the machine has stopped moving and then unlock the door.
		Solution	Check VFD fault light before turning off power. Try a soft reset of the controller with the white button. If problem. Replace PCB controller.
PCB ERROR 2	Controller Internal Fault	Condition	This error is an internal failure of the washer controller related to inputs being matched between the master and slave micros
		Delay	Immediate
		Action	Stop the machine and clear the cycle. Keep the door locked until the machine has stopped moving and then unlock the door.
		Solution	The washer will not restart until the power is removed and re-applied.

Troubleshooting Machine Fault Errors

Fault	Description	Customer Action	
SLOW DRAIN ERROR	Drain Error	Condition	This error is when an empty water level is not reach within 7 minutes.
		Delay	Immediate
		Action	The washer cycle will continue. Do not spin the tumbler with out reaching an empty water level. If empty water level is not reached, agitate during the normal spin time.
		Solution	Check VFD fault light before turning off power. Check to ensure the drain valve is operating properly (slow drain has potential to cause this code). Check to ensure the pressure switch tube is clear of any blockage, and the pressure switch is operating properly. Check the pressure switch harness.
SPIN STOP ERROR	Stop Error	Condition	This error is when the washer does not stop spinning within 150 seconds after receiving the command.
		Delay	Immediate
		Action	Keep the door locked until the machine has stopped moving and then unlock the door.
		Solution	Check VFD fault light before turning off power. Inspect the braking resistors and measure the resistance. Check connecting wiring from braking resistor to the drive mounted in the top of the washer. Reset the drive and try again. Possibly incorrectly programmed drive.
DRIVE ERROR 1	Washer Size/ VFD Size Mismatch	Condition	This error is when the drive size does not match the washer size.
		Delay	Immediate. (after the size jumper configuration is read). Washer size/type inputs are read only at power up, before starting a cycle, once every 24 hours and in factory test mode
		Action	Stop the machine and clear the cycle. Keep the door locked until the machine has stopped moving and then unlock the door
		Solution	Check VFD fault light before turning off power. If the controller was installed in a different size machine before being installed in this machine, a problem can occur. If someone has been doing repairs on the washer, check for the correct size drive. It can also be caused by pressure switch harness. Check to ensure the correct harness in installed. The control can be reset by holding program button on controller during startup (soft reset). Check orange wire at Molex connector on controller coming from pressure switch or replace pressure switch harness.

Troubleshooting Machine Fault Errors

Fault	Description	Customer Action	
DRIVE OC	VFD Over-Current Fault	Condition	This error is an over-current on the VF drive
		Delay	Delay time is 35 seconds
		Action	Stop the machine and clear the cycle. Keep the door locked until the machine has stopped moving and then unlock the door.
		Solution	<p>Step 1: Check to make sure the washer cylinder turns freely by hand. If it turns freely, continue to step 2. If it does not, remove the belt and see if the motor turns freely by hand. If the motor turns freely, then check for obstructions in the cylinder or check the bearings. If the motor does not turn freely, replace the motor.</p> <p>Step 2: Check the motor wires for a short circuit between leads. If there are motor leads that have conductors touching, separate them and insulate them. If the wires are broken, splice them together or replace the motor.</p> <p>Step 3: Check braking resistors to see if they measure the correct resistance. If a resistor does not measure the proper value, replace it.</p>
DRIVE OV	VFD Over-Voltage Fault	Condition	This error is over-voltage on the VF drive
		Delay	Delay time is 35 seconds.
		Action	Stop the machine and clear the cycle. Keep the door locked until the machine has stopped moving and then unlock the door.
		Solution	<p>Step 1: Measure the supply voltage to the VFD on the L1, L2 (or N), and L3 (if connected to three phase power). the supply voltage should be from 187 to 264 VAC or 108 to 132 VAC for a 120 VAC VFD. Also make sure the supply wires on L1, L2 (or N), and L3 (if connected to three phase power) are securely connected.</p> <p>Step 2: Check the braking resistor connections at the VFD. The terminal screws should be tight. Once of the braking resistor wires should be connected to terminal B2.</p> <p>Step 3: Measure each braking resistor separately to make sure they are the correct resistance. (200 for 1 and 2 Hp VFD and 160 for 3 Hp VFD).</p> <p>Step 4: If you have a 240 VAC, high leg voltage supply, try disconnecting the high leg. If this cures the problem, either leave the high leg disconnected, connect a transient voltage surge suppressor (with some form of filtering) at the voltage supply panel, connect a line choke on the high leg or install a VFD filter.</p>

Troubleshooting Machine Fault Errors

Fault	Description	Customer Action	
DRIVE OH	VFD Overheat Fault	Condition	This error is over-heating on the VF drive
		Delay	Occurs following the "DELAY" error (see corresponding detail)
		Action	Stop the machine and clear the cycle. Keep the door locked until the machine has stopped moving and then unlock the door.
		Solution	The washer will not restart until the power is removed and re-applied.
DRIVE OL	VFD Overload Fault	Condition	This error is overload on the VF drive
		Delay	Occurs following the "DELAY" error (see corresponding detail)
		Action	"DRIVE OL"
		Solution	The washer will not restart until the power is removed and re-applied.
DRIVE GFI	VFD Ground Fault	Condition	This error is a ground fault interruption on the VF drive
		Delay	Occurs following the "DELAY" error (see corresponding detail)
		Action	Stop the machine and clear the cycle. Keep the door locked until the machine has stopped moving and then unlock the door.
		Solution	The washer will not restart until the power is removed and re-applied.
DRIVE LV	VFD Low Voltage	Condition	This error is low voltage on the VF drive
		Delay	Occurs following the "DELAY" error (see corresponding detail)
		Action	Stop the machine and clear the cycle. Keep the door locked until the machine has stopped moving and then unlock the door.
		Solution	The washer will not restart until the power is removed and re-applied.
DRIVE IF	VFD Internal Fault	Condition	This error is an internal VF drive error
		Delay	Occurs following the "DELAY" error (see corresponding detail)
		Action	Stop the machine and clear the cycle. Keep the door locked until the machine has stopped moving and then unlock the door.
		Solution	The washer will not restart until the power is removed and re-applied.

Troubleshooting Machine Fault Errors

Fault	Description	Customer Action	
INVALID DRIVE	Drive Is Not The Correct Dexter Version Of The Delta E-drive	Condition	The error indicates the VF drive is not a Dexter version of the Delta E-drive.
		Delay	Immediate (after the Dexter indication value is read from drive). Drive indication value is read only at power up, before starting a cycle, once every 24 hours, and in factory test mode.
		Action	Stop the machine and clear the cycle. Keep the door locked until the machine has stopped moving and then unlock the door.
		Solution	The washer will not restart until the power is removed and re-applied.
SECONDARY FUSE ERROR	Factory Program Error	Condition	This error occurs when the fuse settings for the Slave/Secondary microprocessor have not been set correctly during factory programming
		Delay	None
		Action	When detected, the washer control shall not be operational.
		Solution	The control must be re-programmed with the factory programming tool.
MAIN FUSE ERROR	Factory Program Error	Condition	This error occurs when the fuse settings for the Master/Main microprocessor have not been set correctly during factory programming
		Delay	None
		Action	When detected, the washer control shall not be operational.
		Solution	The control must be re-programmed with the factory programming tool.
DELAY	Communication Loss	Condition	This is an intermediate error code that displays as the control is attempting to re-establish communications with the variable frequency drive. It is a condition of other specified Error Codes (for example Comm Error 6).
		Delay	4 cycles of 10 seconds if during tumble portion of cycle
			4 cycles of 2 minutes if during spin portion of cycle
		Action	Prompt is displayed during each of the specified 10 second or 2 minute periods. Error condition (such as Comm Error4) occurs, but Delay is shown instead of specific Error Code. Action during this time is dependent on the specific error code that caused it.
Solution	No exit strategy. Either communication is re-established or the specific Error Code eventually occurs.		

Troubleshooting Machine Fault Errors

Fault	Description	Customer Action	
CRC ERROR	Firmware corrupted	Condition	This error occurs the washer control firmware fails a CRC check.
		Delay	None
		Action	When detected, the dryer control shall not be operational.
		Solution	The error is fatal. The control must be replaced.

Section 8:

Washer Electrical Wiring Diagrams & Schematics

Electrical Path Circuit Schematics

Start Circuit

Power travels into the machine on L1, L2, (L3, if 3 phase used). L1 and L2 provide 208- 240VAC to the controls transformer which steps the voltage down to 24VAC for the controls. (The L1 connection at the controls transformer must be checked at start-up to coincide with machine operating voltage) The 24VAC travels out from the transformer on X-1 black/red wire to terminal and then through the red wire to the 7 amp circuit breaker. The controls transformer also creates a neutral on the X-2 black/blue wire that connects to terminal block. From the circuit breaker, 24VAC travels on the red wire to the terminal block on the terminal strip.

24VAC (red wires) to the P-7 power connection on the main controller PCB. With the main control PCB now powered, 5VDC will be present between the (2) yellow wires and also the (2) brown wires for the coin switches. Both pairs will now be ready to count coins through the P-2 connection at the control PCB. 26.8 VDC goes out on the black wire of the P-4 connection from the main control PCB to the S5 door closed switch which mounted on the hinge side of the front panel. Closing the door will engage the door closed switch, sending the voltage to the red wire on the S1 door latched switch. Turning the door handle to the vertical latched position closes the S1 door latched switch, returning the voltage to the main control PCB on the white/red wire at the P-4 connection. 26.8VDC is now present at the S2 and S3 door locked switches.

26.8VDC is also at the black and white wires between P-21 at the main control PCB and the P-20 of the relay PCB. This voltage signals the relay PCB that the door is closed and latched making 24VAC available to the relays controlling the door lock gear motor, drain valve, and water valves. A continuous 5VDC is sent on the red wire from the P-1 connector on the main control PCB, through the (normally closed) emergency stop button switch and returns on the second red wire back to the P-1 connector. Payment is added and the display counts down on the main control PCB display until the vend price is satisfied. The display will change to read PRESS START and the green light over the start button will flash. Pressing the start button on the front of the main control PCB signals the relay PCB to lock the door and 24VAC will go to the door lock gear motor on the white/red wire from the P17 connector of the relay PCB. The door lock gear motor engages and pulls up on the door locking rod, locking the door, and closing the S2 and S3 door locking switches.

The S2 locking switch is a backup to the S1 latching switch so that once the cycle starts the S1 isn't critical. The S3 locking switch provides 26.8VDC on the orange wire back to P4 connector at the main control PCB and the P15 connector at the relay PCB. This signals that the loading door is closed, locked, and safe to continue wash operations. This activates the P-13 and P-14 yellow enable wires to the inverter drive to allow motion. If there is no signal on P-15 (orange wire) there will be no motion of the tub. S1, S2, S3, and S5 door switches are now closed. The green On LED and the door lock gear motor (discussed in start circuit) will remain on throughout the cycle.

Fill Circuit-Warm

The relay PCB supplies 24VAC to the brown/yellow wire from P-17 to the drain valve which closes the valve. The lock thermoactuator also receives 24VAC on orange/blue from P17 of the relay PCB. This device prevents the door lock gear motor from dropping out and unlocking during the cycle in the event of a power loss. The 24VAC will cycle on and off keeping the lock thermoactuator engaged until 70 seconds before the end of the cycle. The main control PCB sends data commands to the VFD through the data cable connected at P-6. These commands control the wash basket which will tumble one direction for 12 seconds, pause, and then reverse direction for 12 seconds.

The prewash or wash LED will illuminate at this time, powered through the white wires from the P-3 connection of the main control PCB to the LED printed circuit board. Using the factory preset cycle as an example: The washer fills the tub through the back of the machine with either one or both the C1 cold and H1 hot water valves. From the P19 connection of main relay PCB, 24VAC is sent out on the white/brown wire to the C1 cold water fill valve and the red wire to the H1 hot water fill valve depending on the temperature selected. After a 90 second delay from the beginning of the wash cycle bath only, the detergent dispenser flushes the detergent into the tub for 20 seconds. This is accomplished when 24VAC travels through the orange wire to the H2 hot water valve solenoid. During the machine fill, a 5VDC signal is sent on the red wire from the P5 connection of the main control PCB to the pressure switch contact and returns on the yellow and orange wires to the P5 connection of the main control PCB. When the water level in the basket reaches the preset level pressure, the switch moves the switch contacts to the full or open position. This causes the main control PCB to signal the relay PCB to shut off the water valve coils.

Wash Circuit

Once the machine has achieved it's water level, the wash basket will continue to tumble one direction for 12 seconds, pause, and then reverse direction for 12 seconds. The time on the front display will count down as the bath progresses. The time of the bath is programmable up 15 minutes per bath.

NOTE: When programming cycles, the wash bath must be programmed for 3 minutes or more.

Drain

When the program bath time ends the main control PCB signals the relay PCB to remove 24 VAC power from brown/yellow wire at P17 going to the drain valve. The normally-open, spring-loaded drain valve opens allowing water to exit the machine. This resets the pressure switch back to an empty level and restores the 5VDC connection through the pressure switch from the red wires to the orange and yellow wires.

Rinse 1 & 2

For Rinse 1 & 2, the rinse LED will illuminate, the drain valve will receive 24VAC and close. The basket will fill and tumble the same as the wash bath for the programmed time. The rinse water temperatures are programmable and factory default is cold.

Final Rinse Circuit

The final rinse LED will illuminate, the drain valve will receive 24VAC and close. The basket will fill and tumble the same as the previous baths for the programmed time. The final rinse water temperatures are programmable. **NOTE:** When programming cycles, the final rinse bath must be programmed and cannot be set for less than 3 minutes. Also at the beginning of the final rinse bath, the main control PCB will signal the relay PCB to send 24V to the P-19 connector on the white/blue wire to the C2 cold water valve for 20 seconds to flush the fabric softener dispenser.

Spin Circuit

The spin LED will illuminate and the main control PCB sends a signal to the variable frequency drive via the data cable at P6 to VFD RJ-11. The rotation as viewed from front during spin will be counter-clockwise. The time of the spin cycle can be programmed.

NOTE: The final spin must be programmed into the final rinse bath and must be programmed for 1 minute or more.

Unlock Thermoactuator and Shake Out Circuit

70 seconds before the end of the cycle the main control PCB signals the relay PCB to remove 24VAC from the orange/blue wire at the P-17 connector on the lock thermoactuator. This allows the lock thermoactuator time to cool and retract by the end of the cycle. To insure that the lock thermoactuator has retracted by the end of the cycle, 1 minute prior the end of the cycle, the unlock thermoactuator is powered with 24VAC through the orange/red wire from the P-17 connector of relay PCB. The unlock thermoactuator moves the complete bracket assembly away from the white door lock actuator allowing it to drop at the end of the cycle, unlocking the door. The basket will come to a stop from spin speed with the assistance of dynamic braking resistors wired to the variable frequency drive. (See wiring diagrams for quantities and resistor ohm values). The washer will then tumble for 45 seconds to let the clothes shake loose from the basket and then stop.

End of Cycle and Door Open Circuit

Once the machine stopped, 3 things occur:

1. The enunciator will signal for 3 seconds letting the user know that it is the end of the cycle.
2. The Display of the Washer will scroll "CYCLE DONE THANK YOU".
3. The main control PCB signals the relay PCB to remove power from the white/red wire at P-17 which allows the door lock gear motor to unlock. When the loading door is opened, the S1,S2,S3 and S5 switches are opened. The machine is now ready to accept coins again.

Vended Drive Motor Inverter Type Motor-Winding Resistance Chart

30lb C-Series Washer

Motor	Winding	Wire #	Resistance	
			Minimum	Maximum
30lb 1ph or 3ph 60hzMain (wash & spin) Dexter #9376-305-001		T1 & T2	2.45	2.71
		T2 & T3	2.45	2.71
		T1 & T3	2.45	2.71

NOTE: Resistance values are measured at the stator. Values at the end of the motor wiring harness may be slightly higher.

Wiring Schematic for 60hz Coin Washer

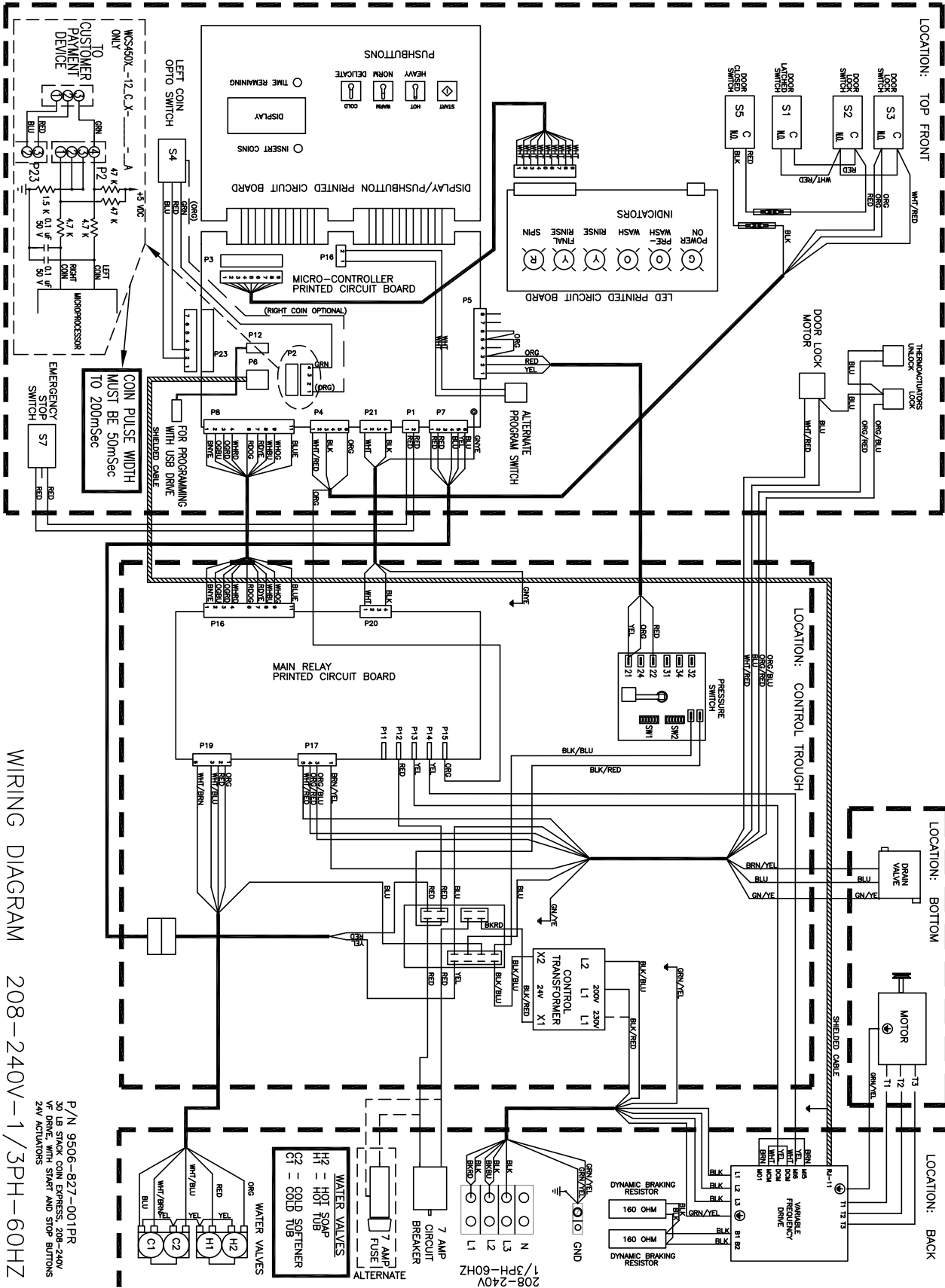

WIRING DIAGRAM 208-240V-1/3PH-60HZ

P/N 9506-827-001PR
 30 LB STACK COIN EXPRESS, 208-240V
 V/F DRIVE, WITH START AND STOP BUTTONS
 24V ACTUATORS

Wiring Diagram for 60hz Coin Washer

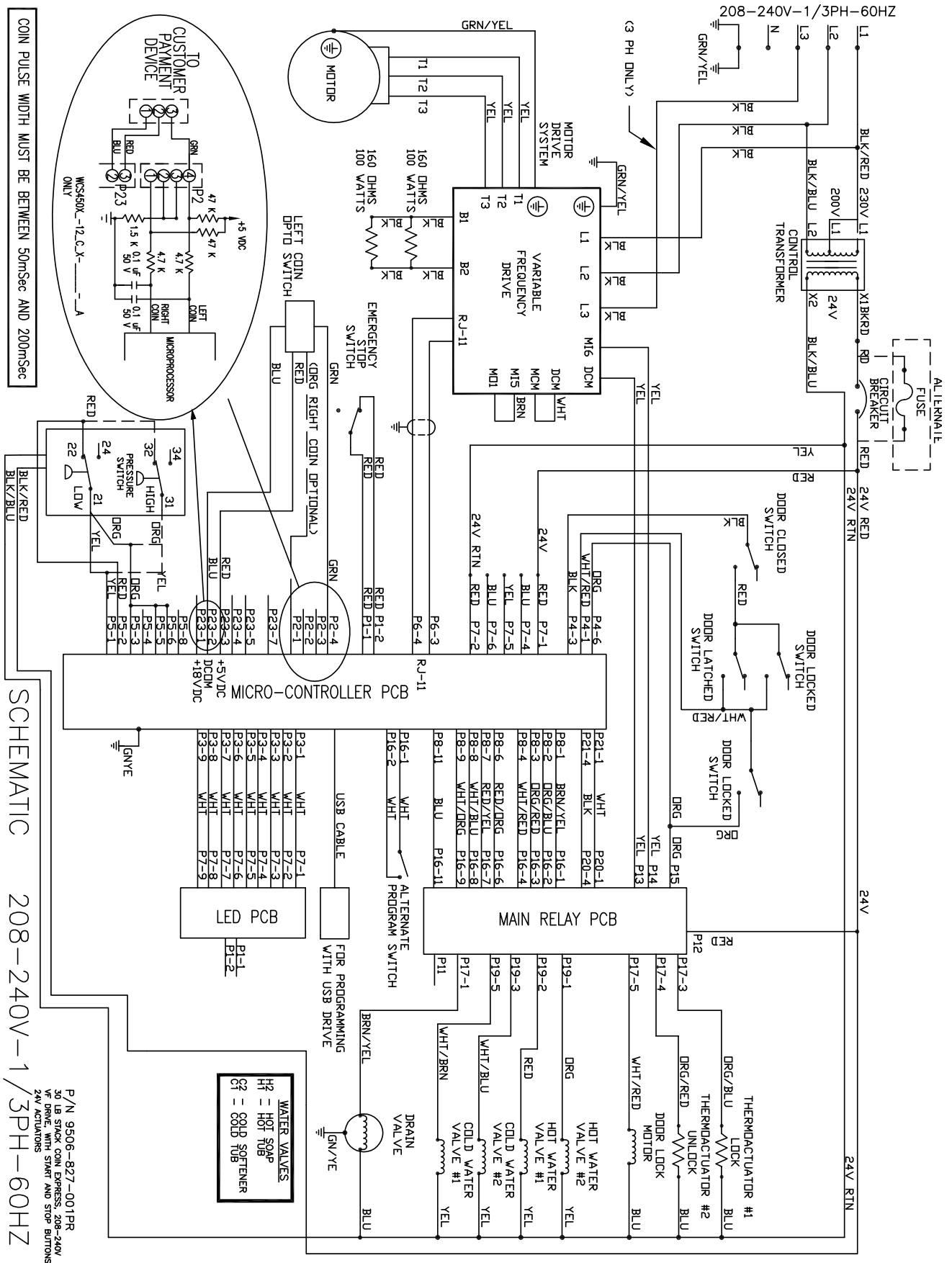

Notes

Lined area for taking notes, consisting of numerous horizontal lines.



Section 9:

Washer Parts

SWD C-Series Accessories T-450

Key	Description	Part Number	Qty
*	Hose, Water Supply 3/8" I.D.	9990-027-011	2
*	Washer, Inlet Hose (furnished)	8641-242-000	2
*	Strainer, Inlet Hose (furnished)	9565-003-001	2
*	Sealing compound	8538-151-002	1
*	TORX#20 Driver	8545-051-002	1
*	Special Tool For Removing Coin Acceptor Mounting Screws. (T-10 Torx)	8545-051-003	1
*	Flow Restrictors (in dispenser)	9475-002-003	3
*	Battery 3V Lithum (used on Control PCB)	8612-001-001	1
*	Coin Bearing & Seal Kit	9732-219-005	1
*	Mode Light Support	9635-022-001	1

Wiring Harnesses Parts

Key	Description	Part Number	Qty
1	Wiring Harness, Door Lock P15/P4	9627-816-002	1
*	Wiring Harness, Coin Drop	9627-916-001	1
2	Wiring Harness, Drain,Thermo,Door Gear Motor P17	9627-820-002	1
3	Data Cable	9806-015-002	1
4	Cableassy-USB	9806-022-001	1
*	Retainer-USB	9486-159-001	1
5	Wiring Harness P20/P21	9627-818-002	1
6	Wire Harness-program switch	9627-910-002	1
7	Wiring Harness P8/P16	9627-819-001	1
8	Wiring Harness Water Valve/P19	9627-795-004	1
9	Wiring Harness LED PCB	9627-821-001	1
*	Harness Power Terminal Block	9627-747-003	1
*	Wire Yellow Jumper (water valve)	8220-123-001	1
10	Harness-Extension, Transformer	9627-826-001	1
11	Harness-P5/Pressure Switch	9627-908-006	1
*	Circuit Breaker 7 AMP	5198-211-002	1
*	Wiring label-schematic/diagram	9506-827-001	1

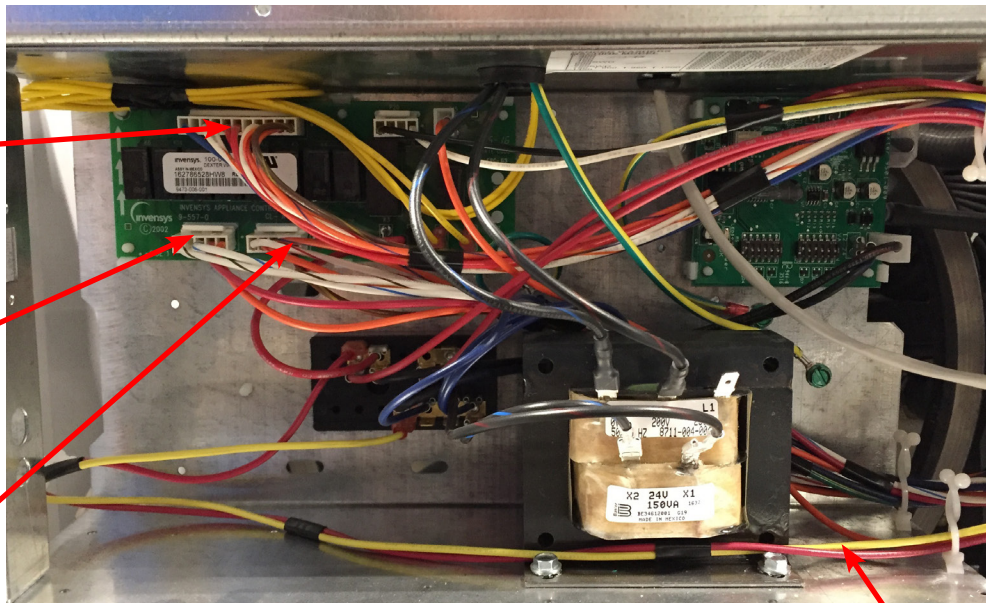
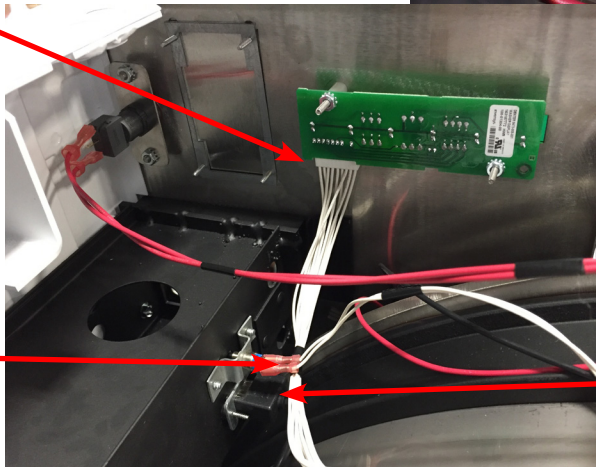
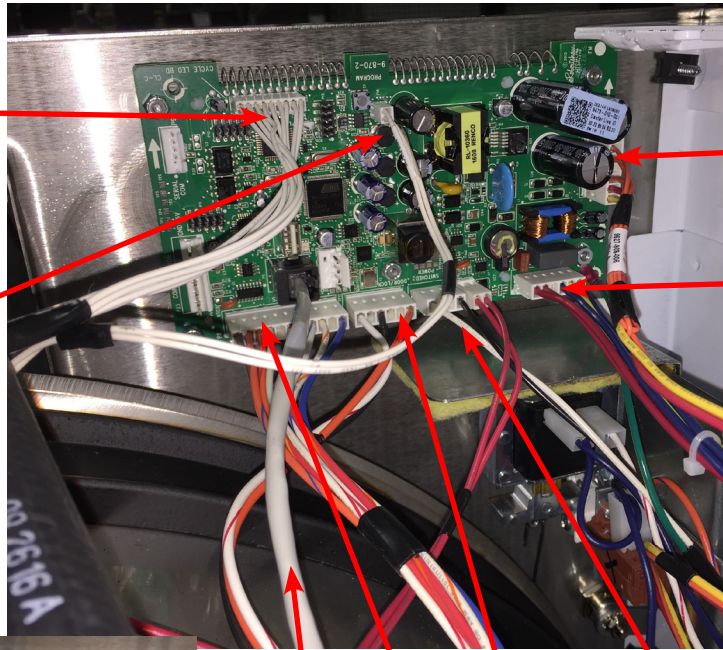

WCS450XA Rear View Access Parts Group

Key	Description	Part Number	Qty
1	Drive Motor, 3 Phase (Inverter duty)	9376-319-001	1
2	Rod, Motor Mtg	9497-222-006	1
3	Motor Bushing (Rubber)	9053-082-001	2
*	Clamp-Worm, 316SS, 1.5" (for Rubber bushing)	8654-117-019	2
4	Strap Bracket, Motor Tension	9029-206-002	1
*	Nut, Strap to Motor	8640-413-002	1
*	Washer	8641-581-006	1
5	Spring, Belt Tension	9534-319-002	1
*	Pulley, Motor	9453-170-003	1
*	Set Screw,Sq.Hd(motor pulley)	9545-028-015	2
*	Tolerance Ring	9487-234-003	1
6	Pulley, Driven	9453-168-003	1
*	Screw 5/8-11x1/2"	9545-060-001	1
*	Lockwasher 5/8"	8641-582-018	1
*	Washer, Flat 5/8x2 1/4"	8641-581-032	2
7	Drive Belt	9040-077-003	2
8	Channel, Rear	9081-190-001	1
*	Screw	9545-008-026	4
*	Nut, Spring	8640-399-007	4
*	Hose, Overflow to drain	9242-449-004	1
*	Clamp, Hose overflow to drain	8654-117-009	2
9	Hose, Overflow Vent Top	9242-463-005	1
*	Clamp, Hose Vent	8654-117-014	1
10	Vaccum Breaker ALL	9610-001-001	1
11	Bracket, Vacuum Breaker	9029-121-001	1
12	Screw, 10B x 1/2	9545-008-026	4
*	Vacuum Breaker Cap (Red)	0935-135-002	*
13	Hose, Vacuum Breaker to tub	9242-458-001	1
*	Plastic Plug 7/8" Electrical Connection	9456-041-006	1
*	Panel Assy., Back	9454-966-001	1
*	Screw Panel Mtg.#10Bx1/2"	9545-008-026	10
*	Screw Panel Mtg.#1/4Bx3/4"	9545-030-002	3
*	Nut, Spring	8640-399-001	8
14	Hose, Pressure Switch	9242-175-005	1
*	Clamp, Pressure Switch Hose	8654-117-015	1
15	VFD Delta "E" drive 208-240 volt	9375-030-016	1
*	VFD Cooling Fan	9189-013-001	1
*	Braking resistors (200 ohm)	9483-004-002	2
16	Bracket assembly (drive mounting)	9029-119-002	1

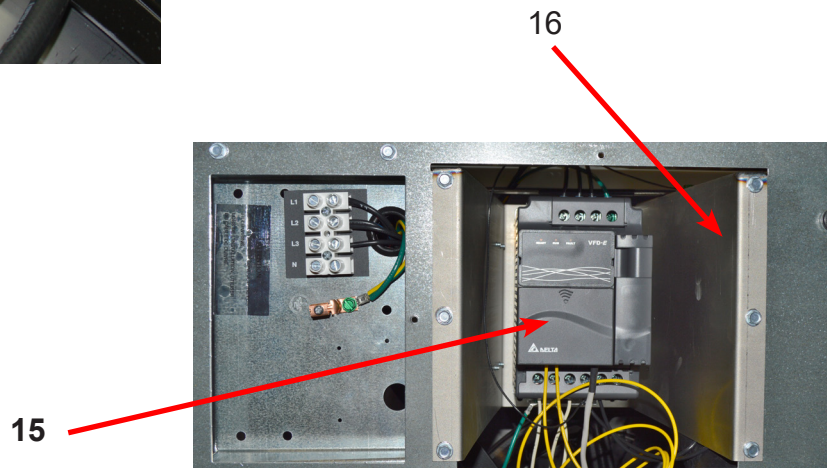
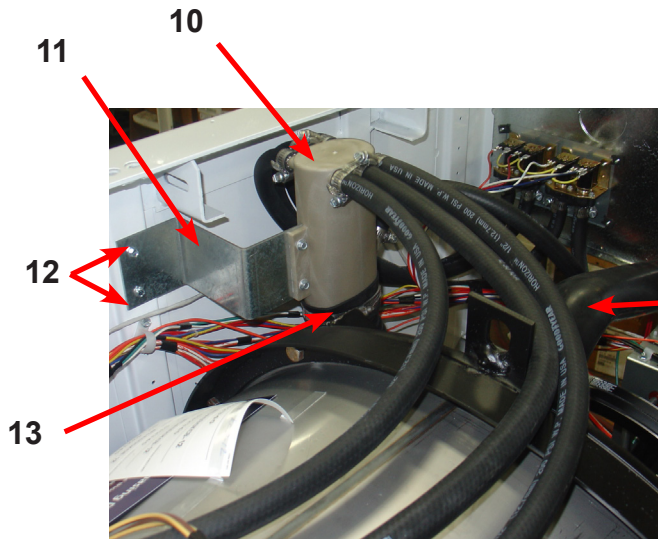
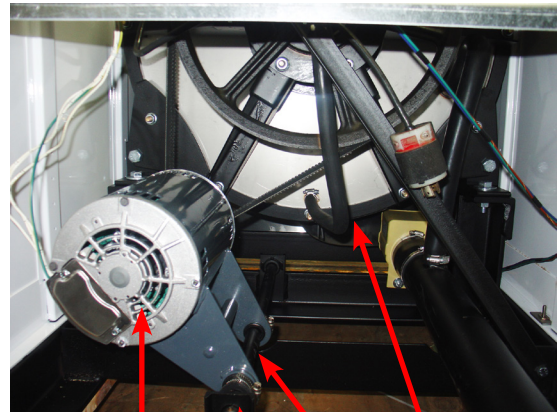
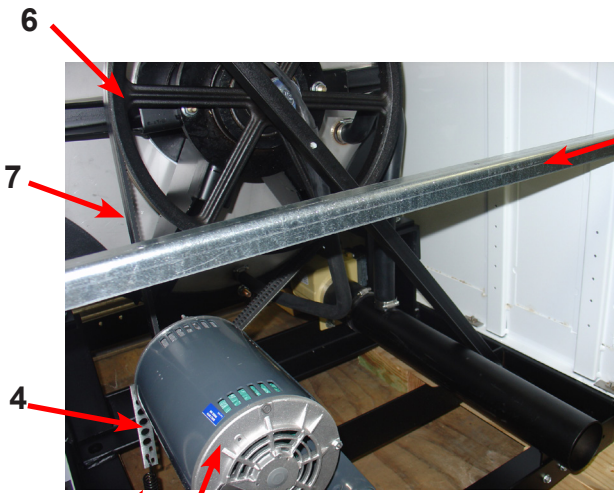

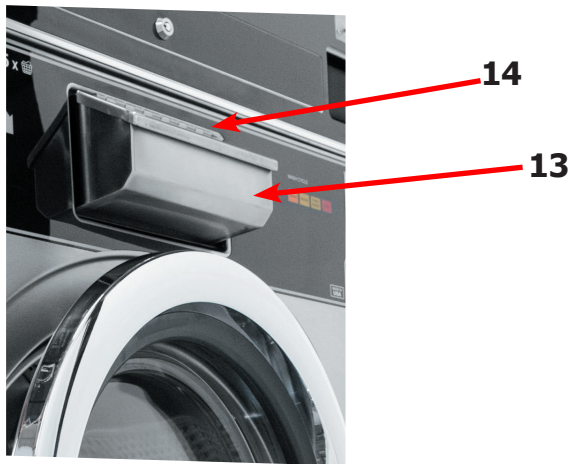
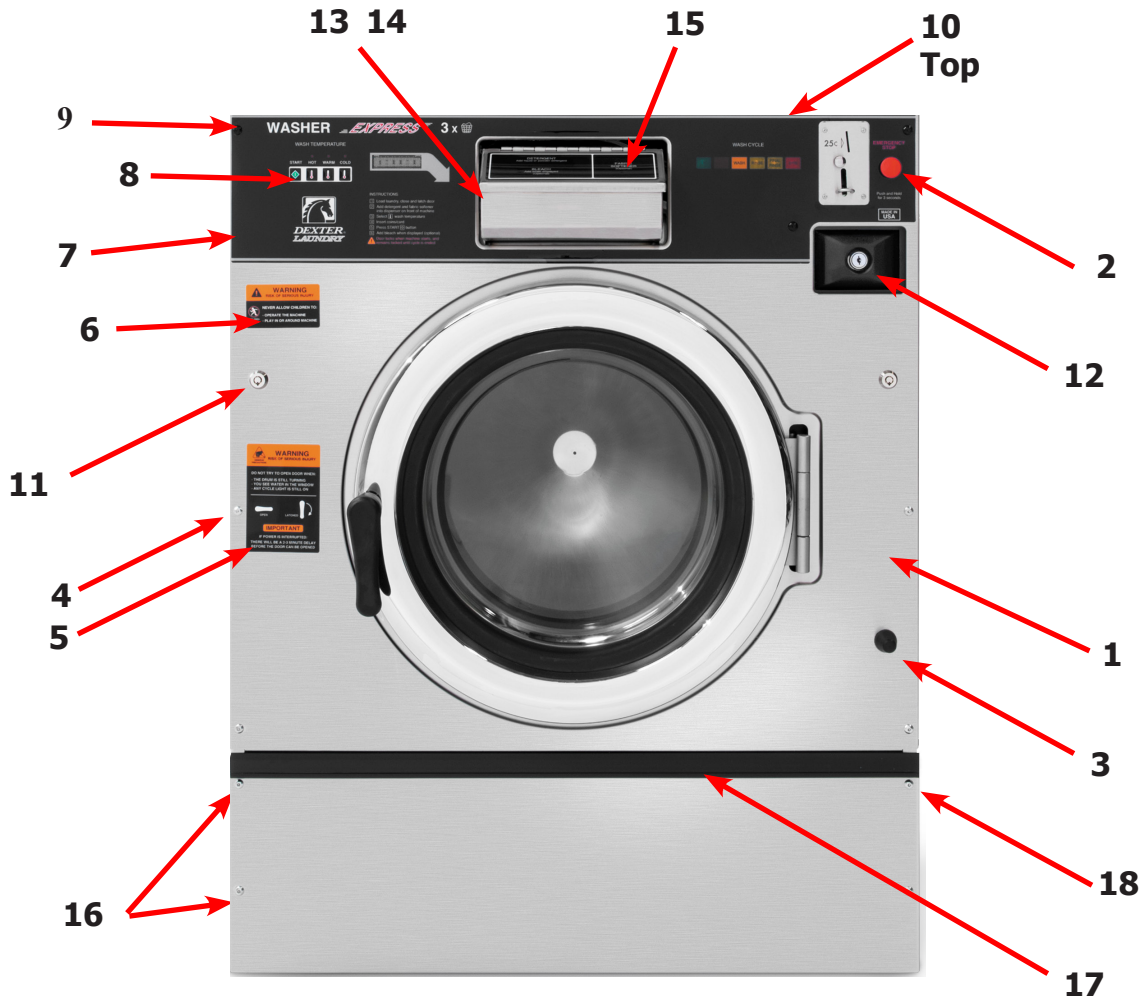

WSC450XA Cabinet and Front Panel Group

Key	Description	Part Number	Qty
*	Panel, Right Side-Painted	9989-604-002	1
*	Panel, Left Side - Painted	9989-605-002	1
*	Screw	9545-018-023	8
1	Panel Assy, Front	9989-606-001	1
*	Trim Edge Protector	9578-092-005	1
2	Switch Assembly, Stop Button Kit	9732-223-002	1
*	Stop Button Mounting Plate	9452-725-001	1
3	Bumper Loading Door	9051-055-001	1
4	Screw, Torx Head- 10AB x 3/4,	9545-008-020	4
*	Nut, Spring-To Front Panel	8640-442-001	4
5	Label, Door Opening, Blue	8502-757-002	1
5	Label, Door Opening, Black	8502-757-001	1
6	Label, Risk of Injury, Blue	8502-759-002	1
6	Label, Risk of Injury, Black	8502-759-001	1
7	Nameplate Decal, Control Panel, Blue	9412-205-002	1
7	Nameplate Decal, Control Panel, Black	9412-205-001	1
8	Button, Push Control, Blue	9035-062-001	1
8	Button, Push Control, Black	9035-062-002	1
9	Screw, Torx Head- 10AB x 3/4, Blue	9545-008-009	2
9	Screw, Torx Head- 10AB x 3/4, Black	9545-008-036	2
10	Panel, Front, Painted	9989-608-002	1
*	Screw, Hex, #10B x 1/2	9545-008-026	8
*	Panel Top Rear	9454-965-001	1
*	Screw, Hex, #10B x 1/2	9545-008-026	6
11	Lock, (w/Key)	8650-012-003	2
*	Key, - # 6324	6292-006-007	1
*	Cam, Lock-	9095-050-001	2
*	Nut, 9/32 - 28 Hex	8640-426-001	2
*	Washer Flat 5/16	8641-581-008	2
*	Coin Vault Assy, Coin	9942-028-003	1
12	Coin Box, Blue	9807-099-001	1
12	Coin Box, Black	9807-099-003	
13	Soap Dispenser Assembly, Complete (Does not include lid)	9807-087-001	1
*	Soap Box mounting Gasket	9206-425-001	1
14	Lid Assembly soap box	9987-104-001	1
*	Lid screws #10-32x1/2 SS	9545-012-017	2
*	Nut Hex Elasticstop #10-32 SS	8640-413-006	6
*	Bracket Soap box mounting	9029-122-002	1
*	Softner siphon tube (plastic)	9574-252-002	1
*	Flow restrictors	9475-002-003	3
15	Label, Dispenser Instructions, Blue	8502-756-002	1
15	Label, Dispenser Instructions, Black	8502-756-001	1
16	Door, Lower Service Assembly	9960-286-009	1
17	Handle, Lower Service Door	9244-086-005	1
18	Screw, Torx Head- 10AB x 3/4,	9545-008-020	4

WSC450XA Cylinder, Seals & Bearings

Description		Part Number	Qty
*	Bearings and Seal Kit	9732-219-005	1
*	Housing, Bearing- Assembly (items #2-#6)	9803-186-001	1
2	Housing, Bearing	9241-180-002	1
3	Bearing, Front (LARGE)	9036-159-005	1
4	Bearing, Rear (SMALL)	9036-159-004	1
5	Spacer, Bearing	9538-167-001	1
6	Ring, Bearing Retainer	9487-238-003	1
8	Seal, Small	9532-140-006	1
9	Seal, Large	9532-140-009	1
10	Ring, Seal Mounting	9950-048-001	1
11	Tub Back Mating Ring	9487-261-003	1
12	Bolt 5/8-11x1 1/2" Tub end of bearing Housing	9545-060-001	6
12	Nut 5/8"-11	8640-425-001	6
13	Support Arm Assy, Bearing Housing	9991-056-002	6
14	Bolt Pulley end of bearing housing, 7/16-14x2"	9545-059-003	6
*	Nut, Flange Locking 7/16"	8640-416-005	6
15	Pulley, Driven	9453-168-003	1
16	Ring, Tolerance	9487-234-003	1
17	Washer 5/8"x 2 1/4"	8641-581-032	2
18	Bolt 5/8-11x1 1/2"	9545-060-001	1
19	Lockwasher 5/8 Ext. tooth	8641-582-018	1
*	Cylinder Assy Before Serial # W1.20190.XXX	9732-354-005	1
*	Cylinder Assy After Serial # W1.20190.XXX	9848-167-001	1
*	Tub and Cylinder Assy.	9869-034-001	1
*	Plastic Plug 1 1/2"-(inside cylinder)	9456-041-007	1

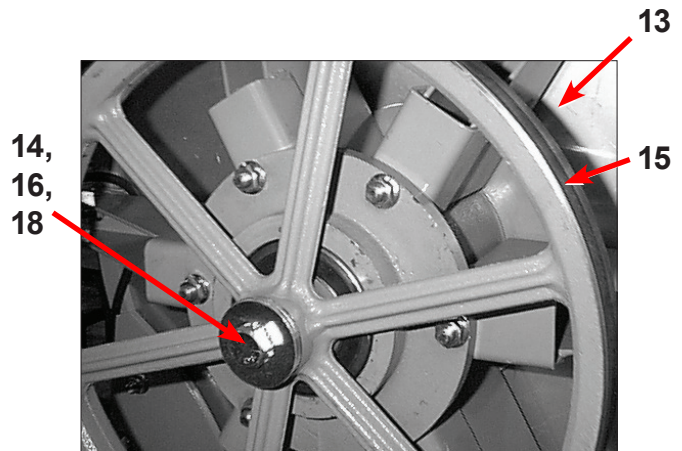
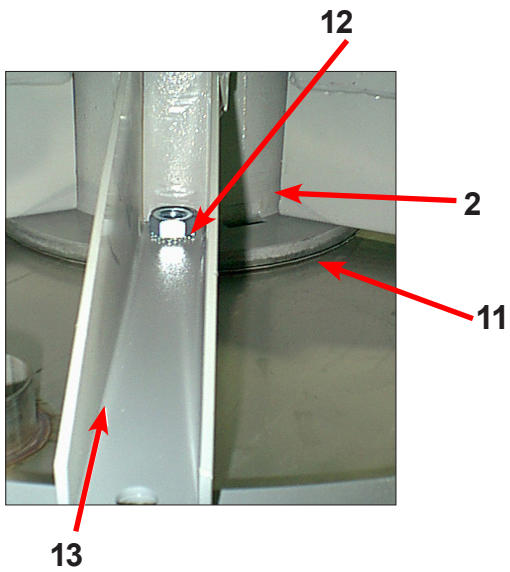
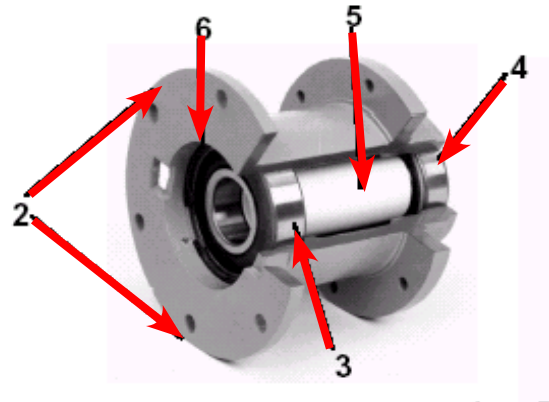
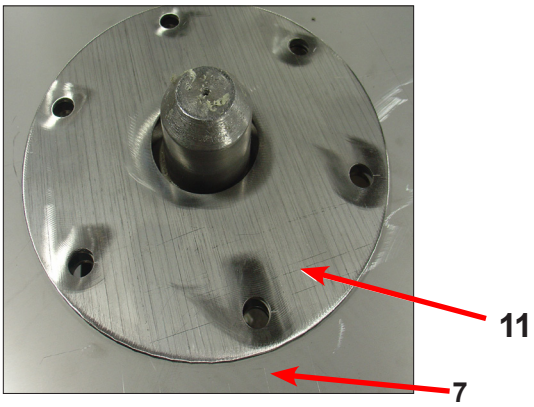
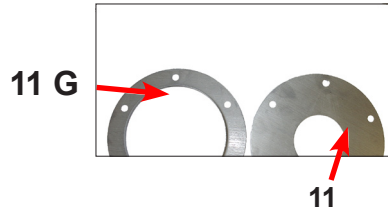
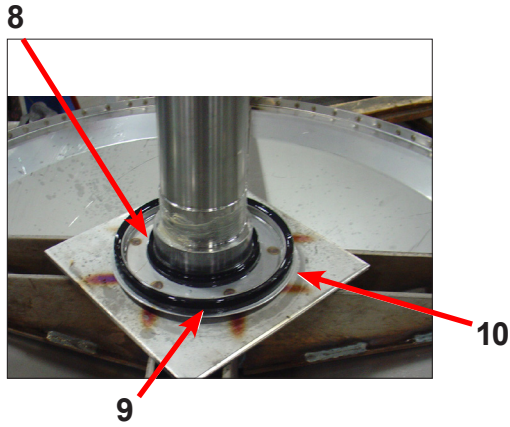
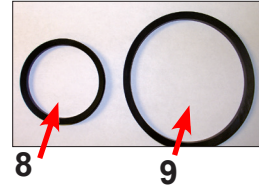
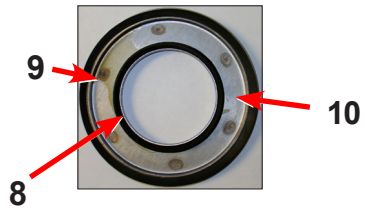

Door Lock Assembly (continued)

Key	Description	Part Number	Qty
33	Lock Assy, Complete (#1-22)(includes #1 thru #22)	9885-024-001	1
1	Plate Assy, Door Lock	9982-346-001	1
2	Washer, Flat	8641-581-030	1
3	Actuator, Latching Switch	9008-005-001	1
4	Pawl, Locking	9732-346-002	1
5	Washer, Spring	8641-569-003	1
6	Ring, Retaining	9487-200-004	1
7	Bracket Switch	9029-163-001	1
8	Nut, Hex 10-32 UNF	8640-413-002	2
9	Spring, Actuating	9534-364-002	1
10	Screw, Hx. 10-32 x 1"	9545-012-020	1
11	Nut, Elastic Stop 10-32	8640-413-004	2
12	Spring, Return	9534-364-001	2
13	Pin, Guide	9451-193-001	1
14	Ring, Retaining	9487-200-005	1
15	Washer	8641-581-031	1
16	Switch, Latching Sensing	9539-461-008	1
17	Shield, Switch	9550-169-003	3
18	Screw 4-40 x 5/8"	9545-020-001	2
18	Nut, Twin 4-40	8640-401-001	1
19	Switch, Locking Sensing	9539-461-007	2
20	Actuator, Switch Locking	9008-006-003	1
21	Screw 4-40 x 1 1/8"	9545-020-003	2
21	Nut, Twin 4-40	8640-401-001	1
*	Spacer Sensor	9538-182-001	*
*	Shim, Door Lock, Thin	9552-037-001	AR
*	Screw, Lock mtg 1/4"-20 x 3/4"	9545-018-014	3
*	Lockwasher 1/4" Ext tooth	8641-582-007	3
*	Door Pin Stud, 3/16" x 3/4"	9451-181-004	1

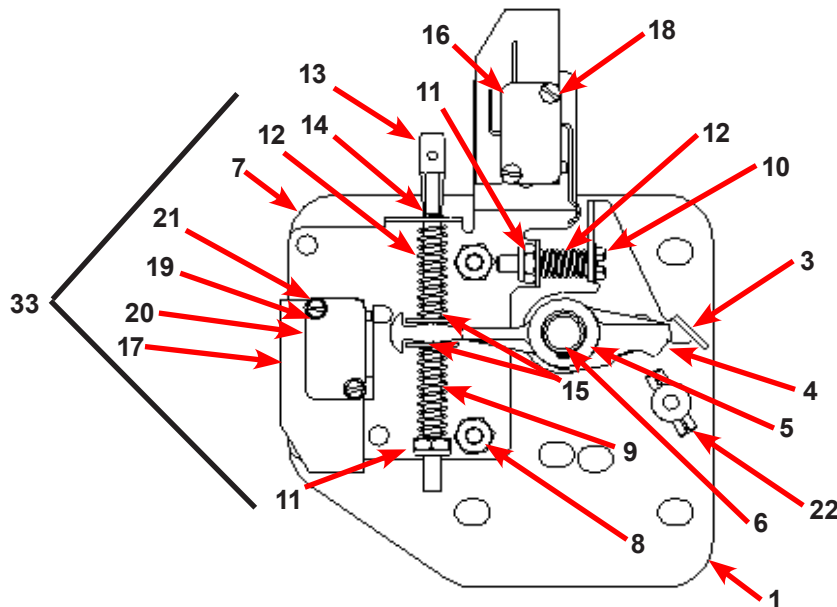

Gear Motor Door Lock Assembly

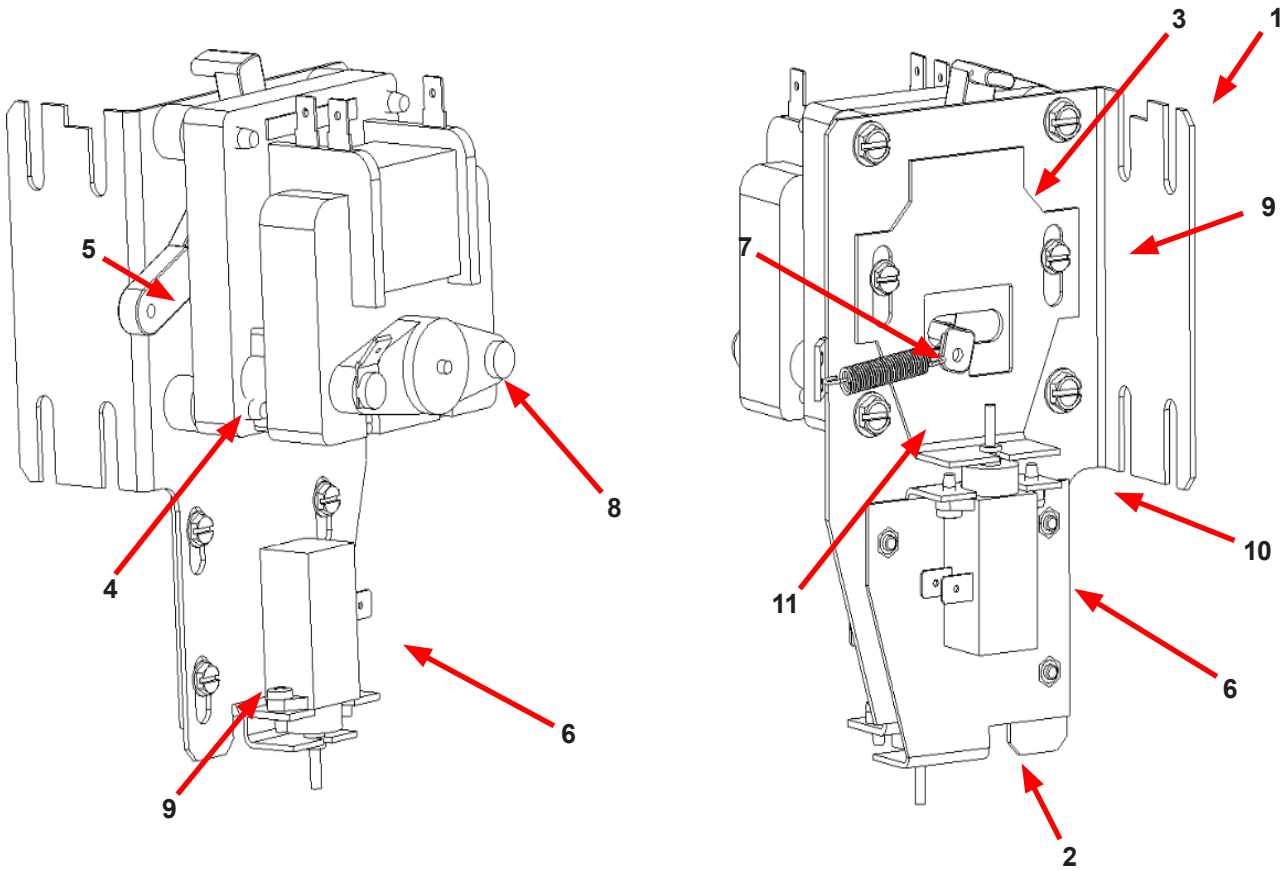

Key	Description	T450	QTY
*	Actuator Assembly (Includes 1-10, Rod NOT included)	9892-017-002	1
1	Bracket Assy, Slide Lock Actuator	9985-199-001	1
2	Bracket Assy, Slide - Unlock	9985-196-001	1
3	Bracket Slide Lock	9029-278-001	1
4	Spacer, Plastic	9538-157-021	4
5	Arm - Door Lock	9001-063-001	1
6	Thermoactuator - Door Lock Relay 24VAC	9586-001-003	2
7	Spring - Extension	9534-350-001	1
8	Motor & Gear Assembly 24VAC	9914-137-014	1
9	Screw -HxwshrhdsIsems, 6-32 x 3/16	9545-044-003	6
10	Cross Recessed PAn Hd Tapping screw	9545-031-011	4
11	Screw hxwshdsl, 10-24 - 1.25f, ctd	9545-046-007	4
12	Standoff-Wire	9527-007-001	1
*	Rod, Door Lock	9497-225-018	1
*	Harness, Door Lock/Drain, P17	9627-820-002	1

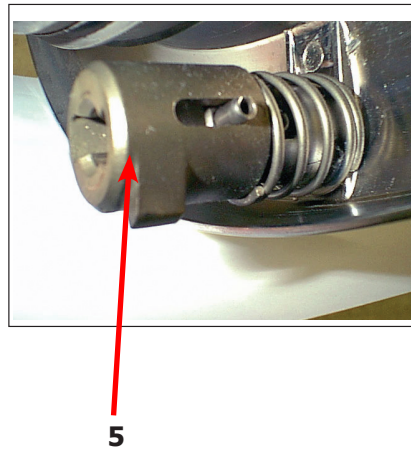
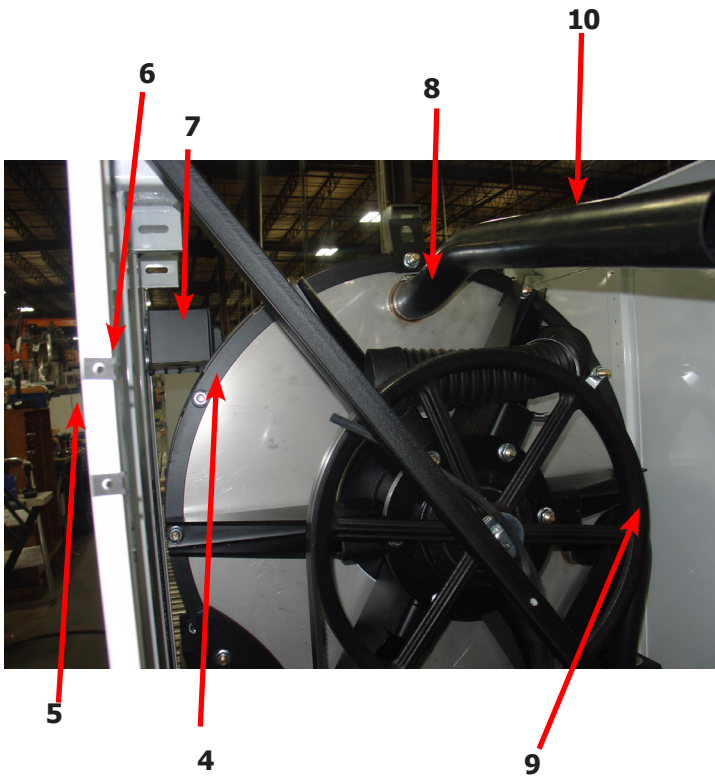
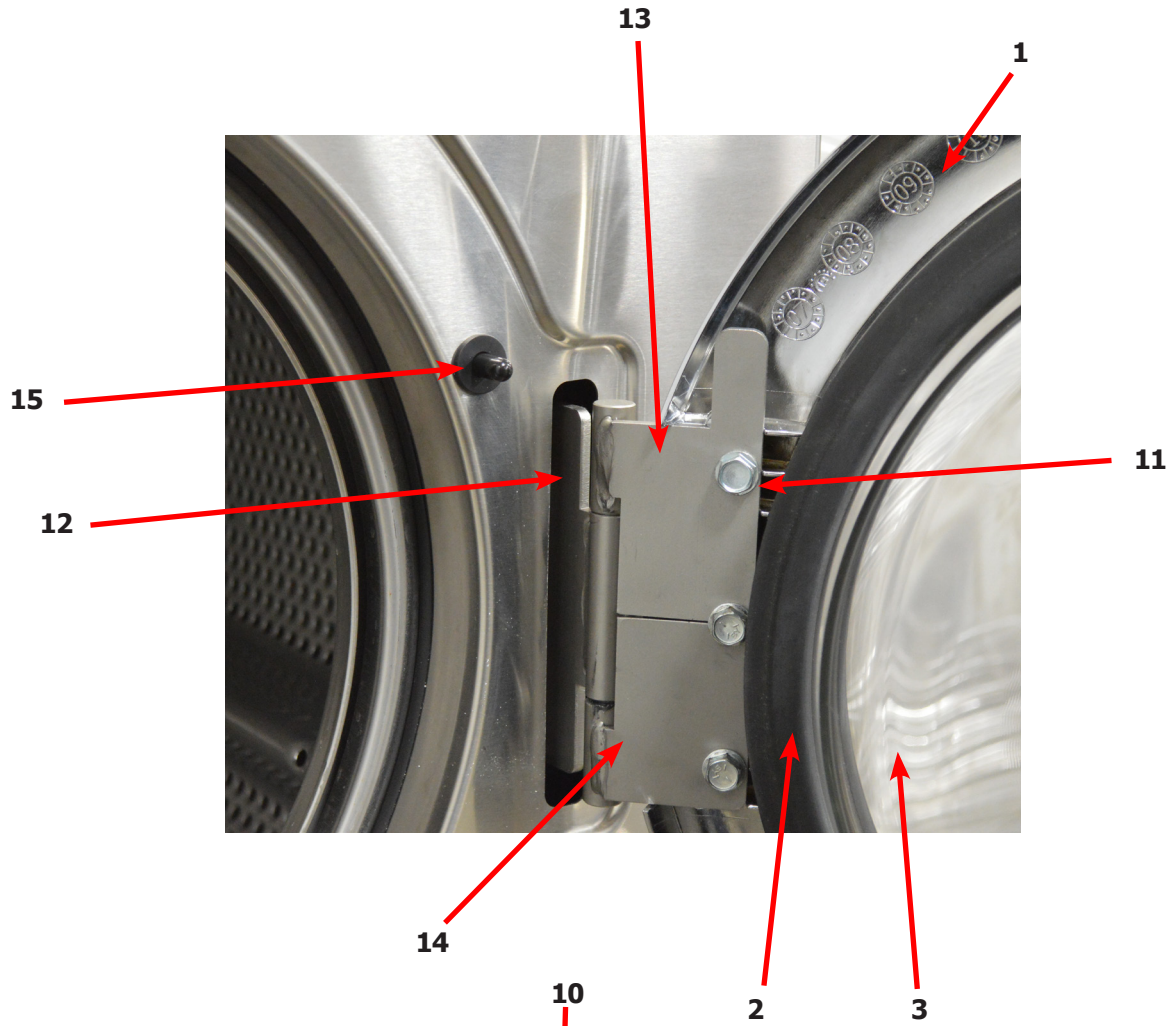

WCS450XA Loading Door Group Part

Key	Description	Part Number	Qty
	Loading Door, Complete #1-10	9960-309-001	1
1	Loading Door, Ring (180 Degreese)	9487-265-002	1
2	Gasket, Loading Door	9206-419-001	1
3	Window, Loading Door	9635-016-001	1
*	Shaft Assy, Locking (includes 4 thru 7)	9913-134-003	1
4	Shaft, Door Locking	9537-195-002	1
5	Cam, Locking	9095-040-002	1
6	Pin, Groove (1 1/4)	9451-181-005	1
7	Pin, Groove (3/4)	9451-181-004	1
8	Spring, Lock Cam	9534-360-002	1
9	Handle, Door	9244-091-001	1
10	Pin, Door Handle (groove)	9451-181-005	1
11	Screw, Loading Door Mtg (5/16" TF)	9545-056-002	3
*	Shim, Loading Door Hinge, Thin	9552-037-001	1
12	Door Hinge Assembly Mounts to Tub Front	9955-030-001	1
*	Screw, Hinge Mtg 5/16" -18x 3/4"	9545-014-009	3
*	Lockwasher 5/16" Ext tooth	8641-582-009	3
*	Wiring Harness doorlock safety Switch Assembly	9627-816-002	1
*	Wire Assembly Door Close Switch, Red 17"	8220-063-025	1
*	Wire Assembly Door Close Switch, BLK 17"	8220-063-026	1
13	Leaf assembly, Hinge Top	9845-008-001	1
14	Leaf assembly, Hinge Bottom	9845-005-002	1
15	Switch Door Closure	9539-492-001	1

Drain Valve Group Part # by Model

Key	Description	Part Number	Qty
1	Valve, Drain (includes #2 thru #11)	9379-202-002	1
2	Body, Valve (w/ball)	9064-072-001	1
3	Motor & Gear Train (complete)	9914-137-022	1
4	Plate, Motor Mtg	9452-538-001	1
5	Screw	8639-994-001	1
6	Spring, Drive	9534-339-001	1
7	Screw	9545-054-001	1
8	Screw	9545-054-002	1
9	Seal, V Packer	9532-134-001	1
10	Washer	8641-584-001	1
11	Pin, Main Drive	9451-196-001	1
*	Plate (spacers needed for replacement motor mtg. plate)	9538-149-001	1
12	Kit - Seal Replacement	9732-327-001	1

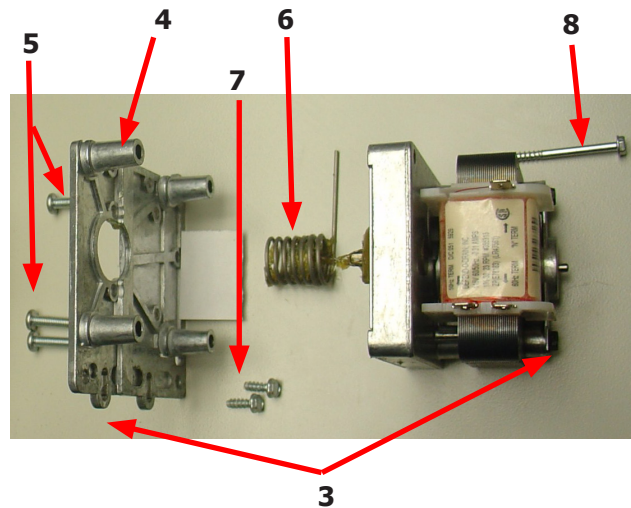
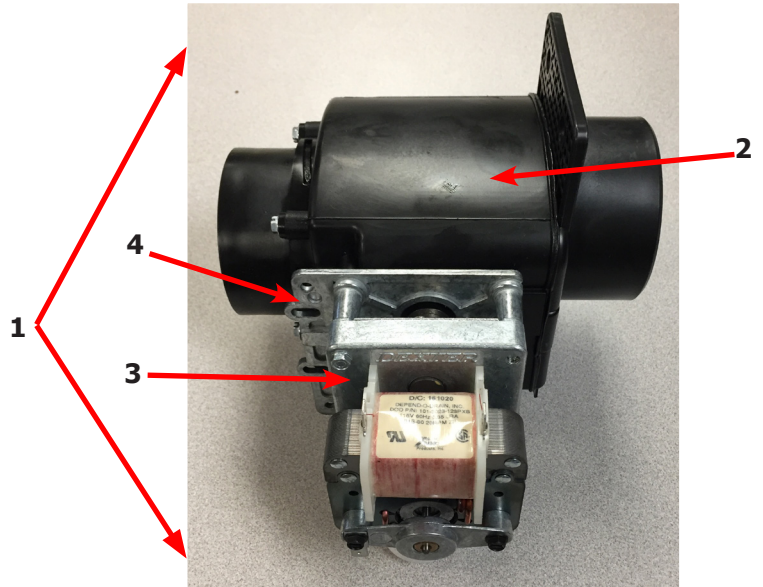
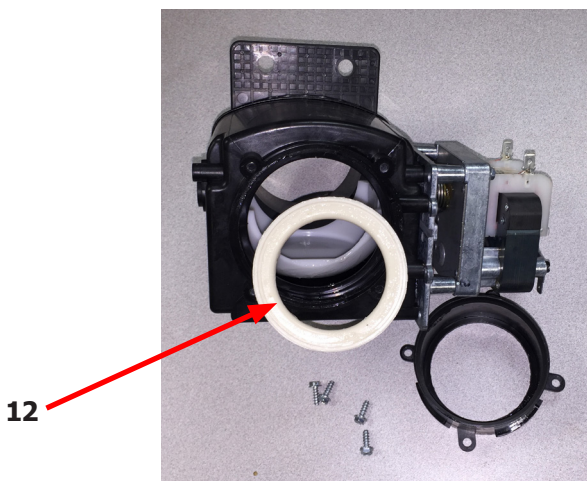

Water Inlet Valve Breakdown

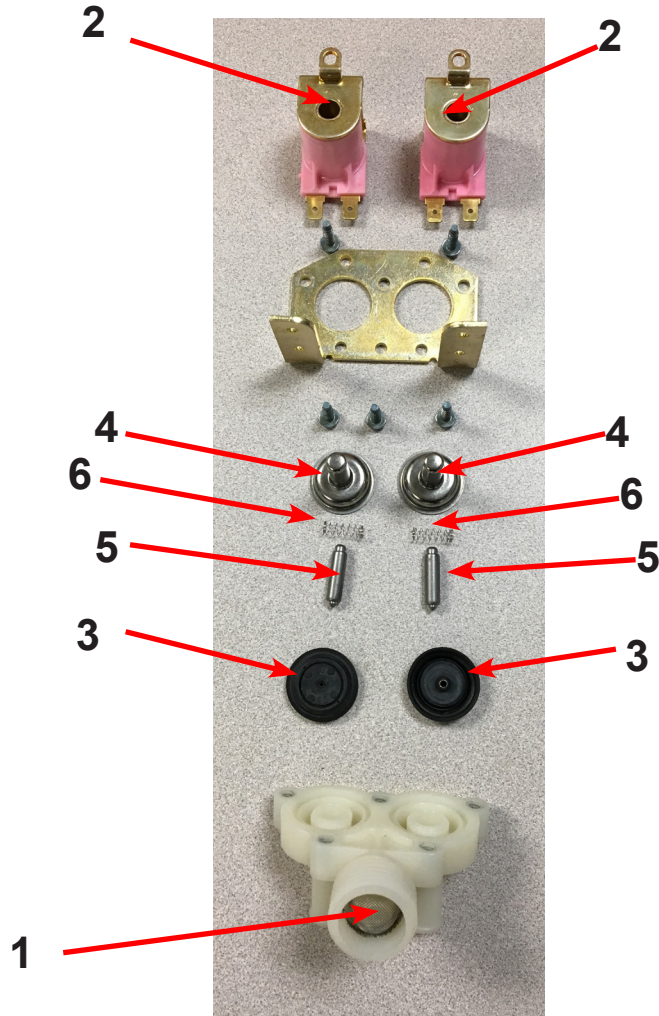

Key	Description	Part Number	QTY
*	Valve, Water Inlet (includes 1 thru 6) - Invensys	9379-183-013	2
1	Screen, Inlet end of valve	9555-056-001	2
2	Coil Assy., 24 V Invensys	9089-017-004	2
3	Diaphragm Invensys (EPDM)	9118-049-003	2
4	Guide, Solenoid Invensys	9211-021-002	2
5	Armature Invensys	9015-008-001	2
6	Spring, Armature Invensys	9534-298-001	2

WCS450XA Chassis and Drain by Part

Key	Description	Part Number	Qty
1	Base Assy,Frame	9945-150-002	1
*	Outer Tub Assy	9930-166-001	1
*	Cylinder Assembly, (Includes Spider)	9848-120-001	1
3	Back Ass'y, Tub	9962-013-003	1
4	Bolt, 7/16" x 2" Tub Back to Tub	9545-059-002	12
5	Nut, Flange Lock	8640-416-005	12
*	Bolt, 5/8-11 x 1 1/2 Tub to Base, Front	9545-060-001	2
*	Nut, 5/8-11 Wizlok	8640-425-001	2
*	Ring Assy, Tub Mtg-Front	9950-051-004	1
*	Bolt, Top Front Ring 5/8" x 3"	9545-017-016	1
*	Nut 5/8"	8640-417-005	1
6	Ring Assy.Clamp Tub Mtg.- Rear	9950-056-002	1
7	Bolt, 5/8-11 x 1 1/2 Tub to Base, Rear	9545-060-001	2
8	Nut, 5/8-11 Wizlok	8640-425-001	2
9	Bolt, 5/8-11 x 2 Tub & Rings to Base, Front & Rear	9545-060-004	4
10	Washer	8641-581-038	4
11	Nut, 5/8-11 Wizlok	8640-425-001	4
12	Hose, Overflow	9242-449-004	1
13	Clamp	8654-117-018	2
14	Tube, Over Suds	9242-463-005	1
*	Clamp	8654-117-014	1
15	Hose, Tub to Drain Valve	9242-464-001	1
16	Valve, Drain	9379-202-002	1
*	Screw, Valve to Bracket 5/16-18x1 1/4	9545-014-012	2
*	Nut, 5/16-18	8640-400-003	2
17	Hose, Drain Valve to Tube	9242-457-001	1
*	Clamp, Hose (Drain Valve to Tube)&(Srain Hose to Valve)	8654-117-009	2
*	Screw Tube (Bracket to Base 1/4B x 3/4)	9545-030-002	2
18	Tube Assy, Drain	9915-122-002	1
19	Hose, Vacuum Brkr. to Tub	9242-458-001	1
*	Clamp	8654-117-014	2
20	Hose, Pressure Switch	9242-175-005	1

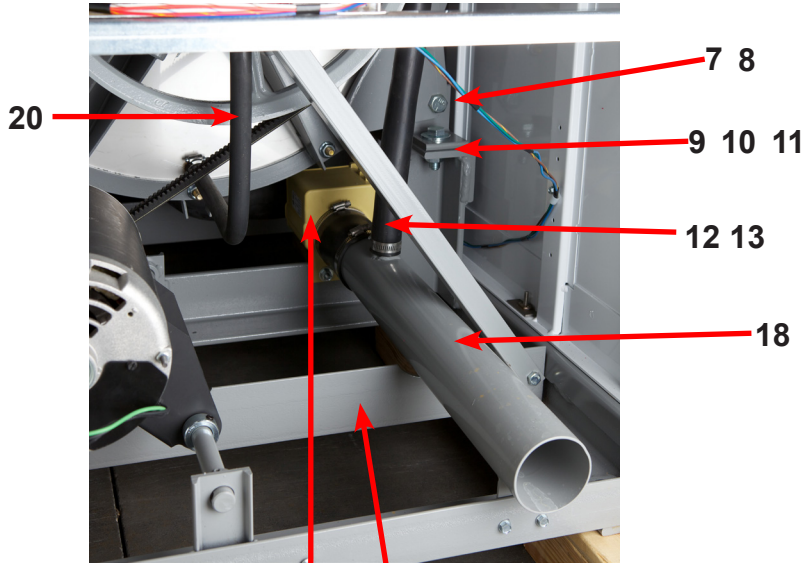

1
16

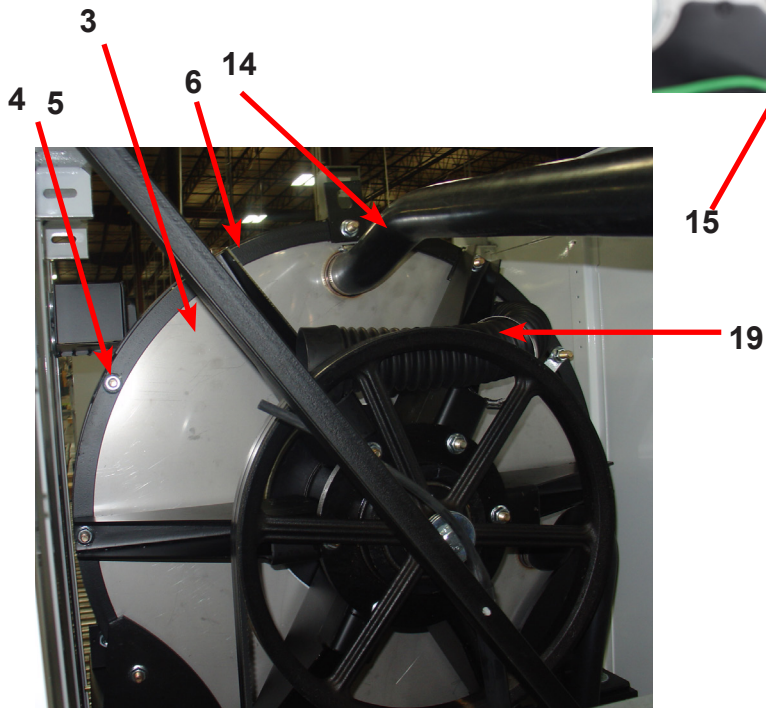
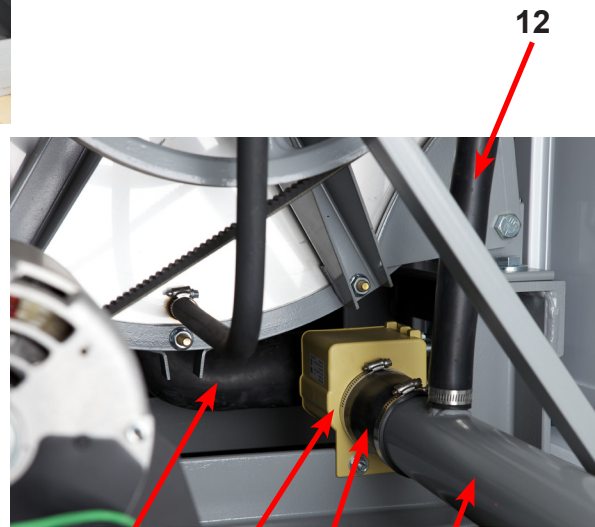

Electrical Components, Control Trough

Key	Description	Part Number	Qty
1	Trough Assy,Controls 208-240 volt	9857-235-001	1
	Trough only	9839-018-001	1
2	Transformer, Control (208/230/60 Hz In 24 VAc Out Volts)	8711-004-004	1
*	Wire Assembly, Red 28"	8220-062-025	2
*	Screw, #10B x 1/2	9545-008-026	4
*	Lockwasher #10	8641-582-006	4
*	Wire Assembly, BLK/BLU	8220-001-231	1
*	Wire Assembly, BLK/RED	8220-001-230	1
3	Terminal Block Assy, POWER	9897-026-004	1
*	Screw, Mtg 8ABx1/2"	9545-045-012	2
*	Harness-extention, Transformer	9627-826-001	1
*	Screw, 8B x 1/4	9545-045-001	2
*	Lockwasher-External Tooth, #6	8641-582-005	2
*	Wire Assembly, P12, Red 7"	9631-381-018	1
4	PCB assembly Relay Main	9473-006-001	1
*	PCB support 3/8 edge Holding	9548-285-001	10
*	Wiring Harness, Door Lock P15/P4	9627-816-002	1
*	Wiring Assembly Yel. 32" P14 & P13	8220-064-023	2
5	Wiring Harness, Drain,Thermo,Door LockP17	9627-820-002	1
6	Wiring Harness WaterValve/P19	9627-795-004	1
7	Wiring Harness P8/P16	9627-819-001	1
*	Wiring Harness P20/P21	9627-818-002	1
8	Sensor-Pressure Switch	9732-315-001	1
9	Harness Assembly, Pressure Switch	9627-908-006	1
10	Wiring Harness-Main	9627-914-002	1

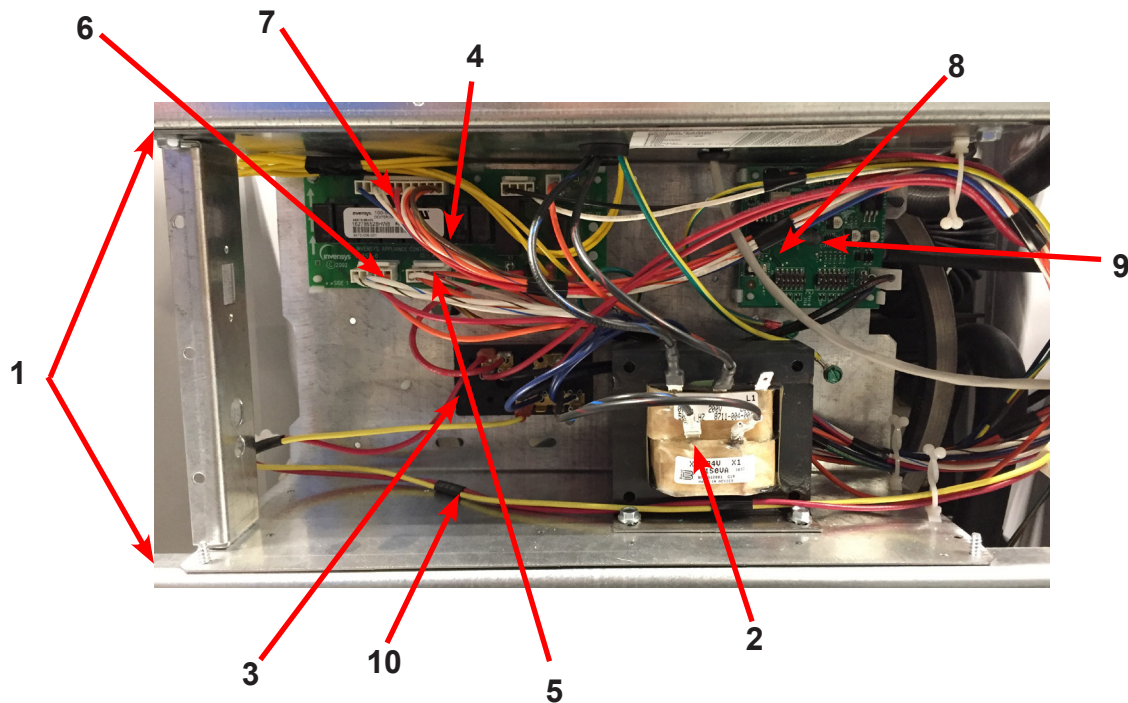

Electrical Components, Upper Channel

Key	Description	Part Number	Qty
1	Terminal Block Assy, POWER	9897-033-002	1
*	Screw, Mtg 6ABx3/4"	9495-031-010	2
2	Strip, Terminal Marker	9558-025-001	1
3	Terminal, Lug-Solderless (Ground)	8652-134-001	1
*	Screw, 10-32TTx1/2 Green (Control Trough)	9545-008-027	
*	Wiring Harness Power Terminal To VFD & Control Transformer and ground wire	9627-747-003	1
4	VFD Delta drive 208-240 volt	9375-030-016	1
*	Cable, Data Communication	9806-015-002	1
*	Wiring Assembly Yel. 32"	8220-064-023	2
5	Braking resistors (160 ohm)	9483-004-002	2
*	Wire Assembly-Jumper, BLK (Breaking Resistors)	8220-117-002	2
*	Label Fusing and Installation 7 amp Rear	8502-619-004	1
6	Circuit Breaker 7 AMP	5198-211-002	1
*	Plate Mounting water vavles	9452-691-001	1

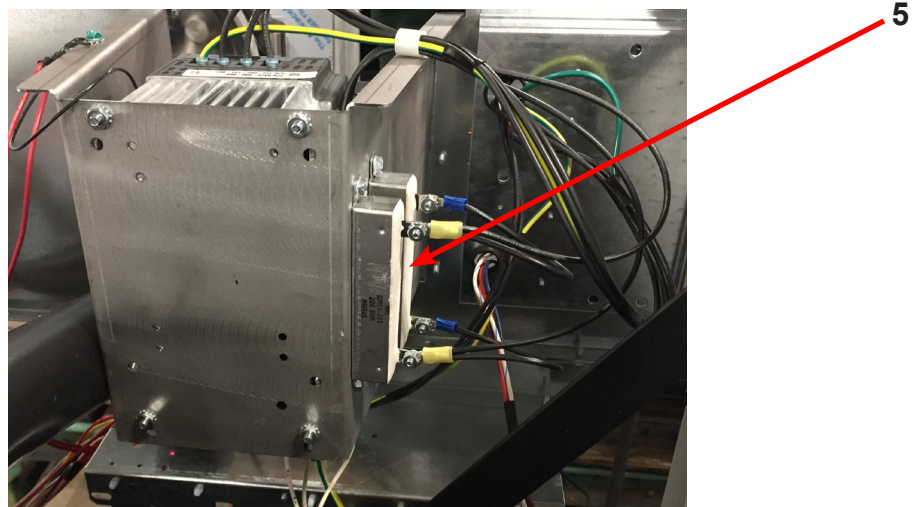
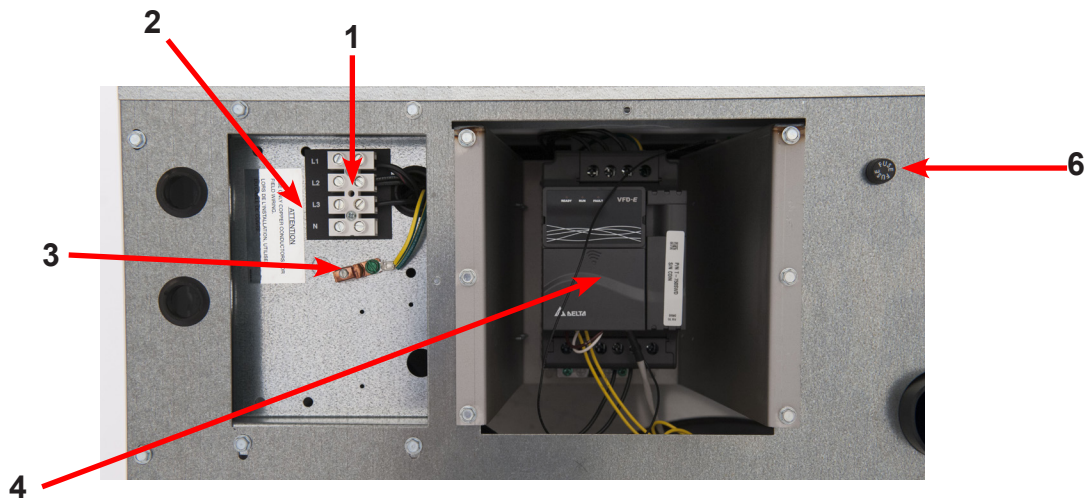

Front Panel Control Group Part

Key	Description	Part Number	Qty
*	Nameplate,Control Panel Blue (one piece)	9412-205-002	1
*	Nameplate,Control Panel Black(one piece)	9412-205-001	1
1	PCB assembly Control /Display	9473-010-001	1
*	Spacer Pushbutton (Micro)	9538-192-001	1
*	Retainer Pushbutton (Micro)	9486-160-001	1
*	Nut Hexelasticstop #4-40	8640-424-002	2
*	Pushbutton Control (coin)	9035-062-001	1
*	Spacer Plastic #6x9/16	9538-157-018	5
*	Nut Elasticstop #6-32	8640-411-002	4
*	Nut-Hexkeys, #6-32	8640-411-003	1
2	Harness LEDPCB	9627-821-001	1
3	Harness Doorlock, Switches	9627-816-002	1
4	PCB assembly Mode lights	9473-005-001	1
*	Spacer Plastic #6x9/16	9537-157-018	2
*	Nut Hexkeys #6-32	8640-411-003	2
5	Switch Assembly Emergency Stop (includes Wire Harness)	9732-223-002	1
*	Spacer Plastic #8x5/16 E-Stop	9538-157-020	2
*	Nut HexKep #8-32 E-Stop	8640-412-005	2
*	Plate to mount e-stop button	9452-725-001	1
6	Door Locking Actuator 24 volts	9892-017-002	1
*	Hex Nuts (mounting gear motor to control)	8640-412-005	4
7	Battery	8612-001-001	1
8	Program-switch	9539-495-001	1
*	Wiring Harness program switch	9627-910-002	1
*	Bracket-Program switch	9029-267-001	1

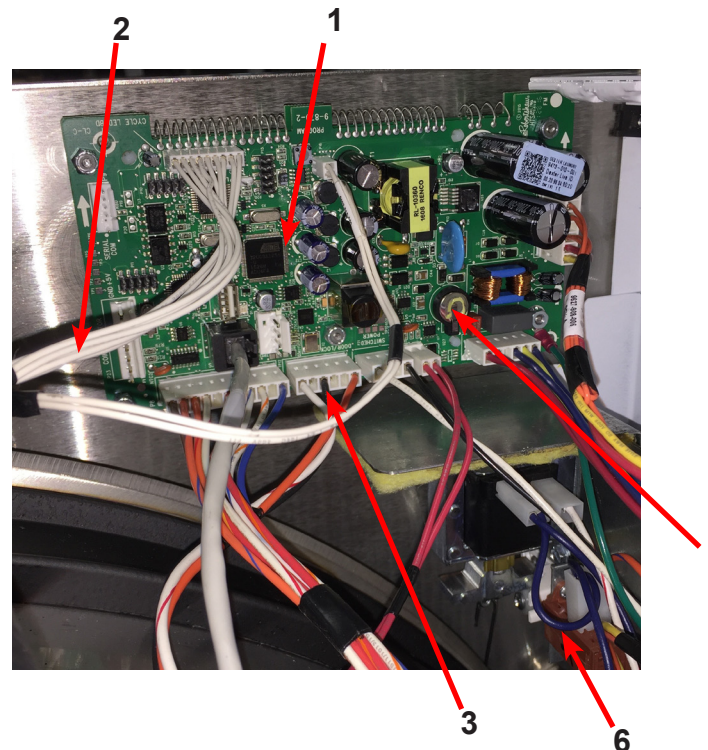
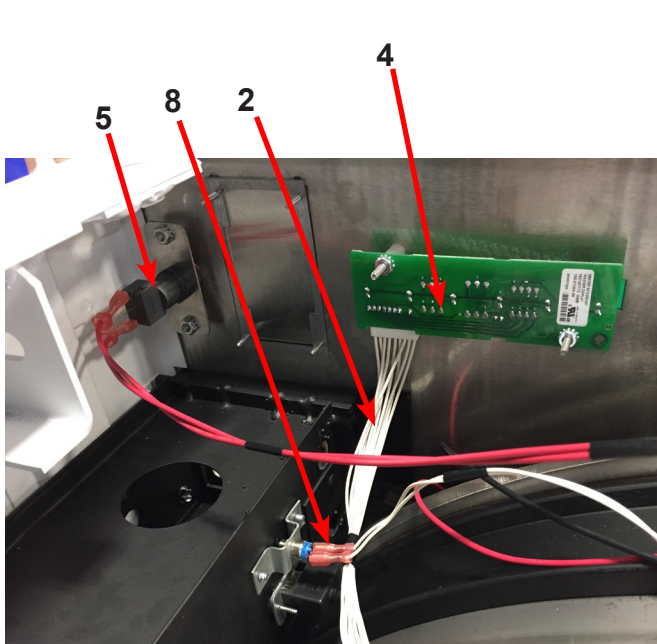

Labels and Diagrams by Part

Key	Description	Part Number	Qty
*	Wiring Diagram, Coin	9506-827-001	1
1	Label High Voltage Warning	8502-614-004	1
*	Cover controls	9074-267-001	1
2	Label Fusing & Installation	8502-619-004	1
3	Label Warning Risk of Injury Blue	8502-759-002	1
*	Label Warning Risk of Injury Black	8502-759-001	1
4	Label Warning Door Opening Blue	8502-757-002	1
*	Label Warning Door Opening Black	8502-757-001	1
*	Booklet Owners	8514-284-001	1
5	Label, Dispenser Instructions, Blue	8502-756-002	1
*	Label, Dispenser Instructions, Black	8502-756-001	1
6	Cover-Motor Control	9074-268-001	1

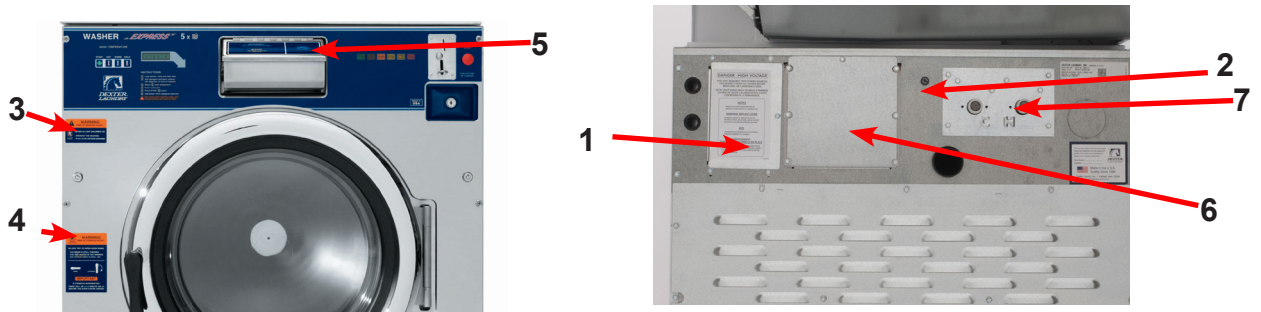

Coin Handling by Part

Key	Description	Part Number	Qty
8	Vault, Assy	9942-028-003	1
*	Screw, 10B x 1/2" Vault Mtg	9545-008-026	4
9	Coin Acceptor Complete (Optical Switch)	9021-094-001	1
*	Screw, Acceptor Mtg	9545-053-002	4
*	Button Coin Return Retainer	9486-145-001	1
*	Harness Coin Switch	9627-916-001	1



Coin Handling Group

Key	Description	Part Number	Qty
	Coin Acceptor, Optical, SWD, US Quarter	9021-094-001	1
*	Harness-Extension ,Control to Acceptor, Optical Dryer	9627-916-001	1
*	Retainer, Coin Acceptor	9486-145-001	1
*	Screw, Torx	9545-053-002	4
1	Switch Assembly, Optical Sensor, SWD	9801-099-003	1
*	Screw-Height Bar, 3mm	9545-039-002	2
	Below not included		
*	Harness, Acceptor Mechanical (Control to Acceptor)	9627-783-003	1
*	Coin Vault	9942-028-003	1
	Screw, 10AB X 1/2	9545-008-024	2

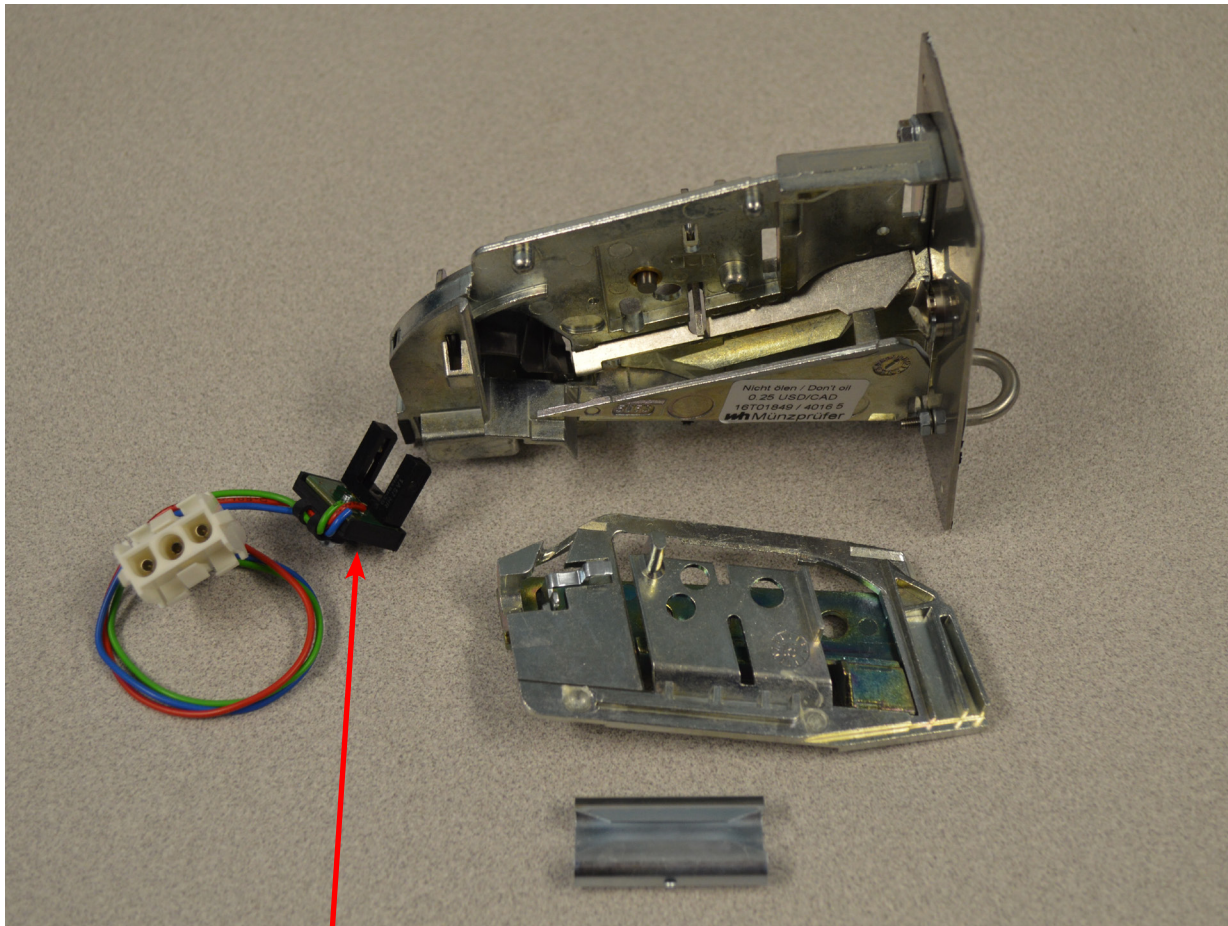

1

Coin Handling Group Electronic

Key	Description	Part Number	Qty
	Kit, Electronic Coin Acceptor	9732-303-004	1
	Acceptor-Electronic, US/CA	9021-054-001	1
	Harness, Control to Acceptor, Dryer	9627-909-003	1
	Harness, Control to Acceptor, Washerr	9627-909-002	1
	Lable-Wiring, Electronic Acceptor	8502-730-001	1
	Retainer Coin Acceptor, Electronic	9486-155-001	2
	Screw, 4B x 5/8 ss, Torx T-10	9545-053-002	4
	Below not included		
	Harness, Adaptor Electronic to Mechanical switch	9627-901-001	

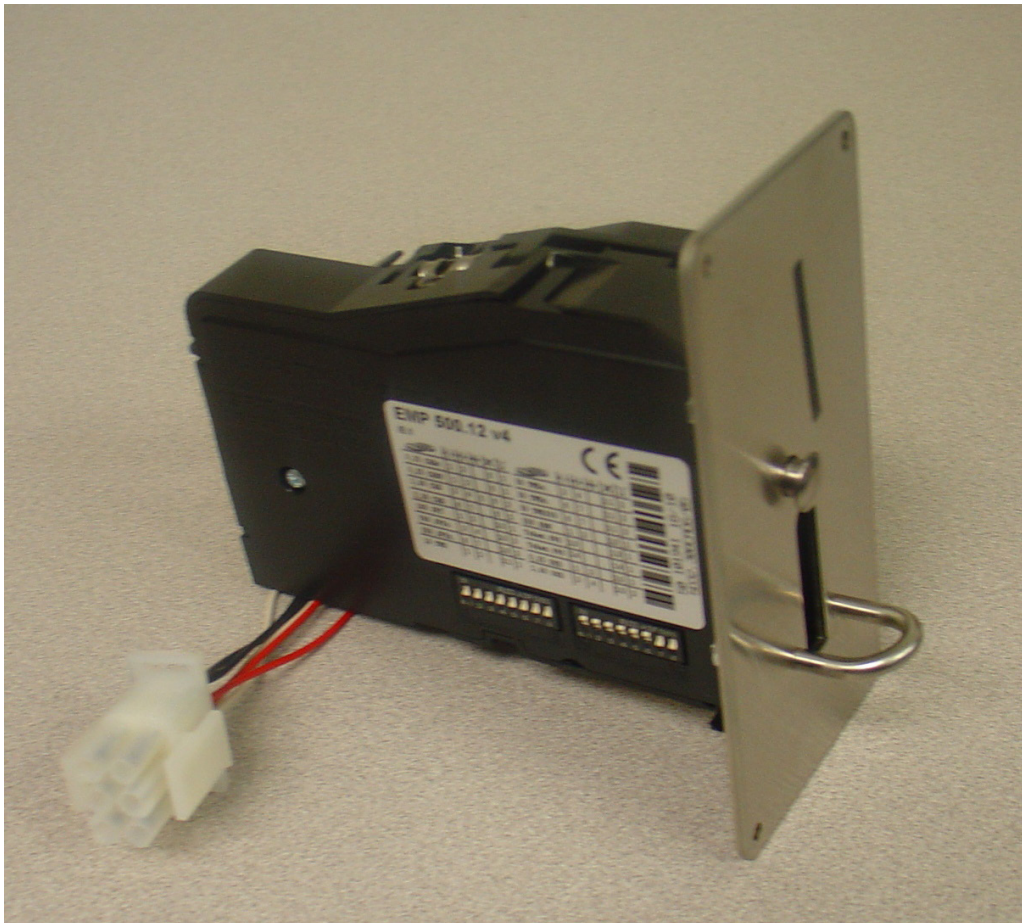

Wiring Schematic for 60hz Coin Washer

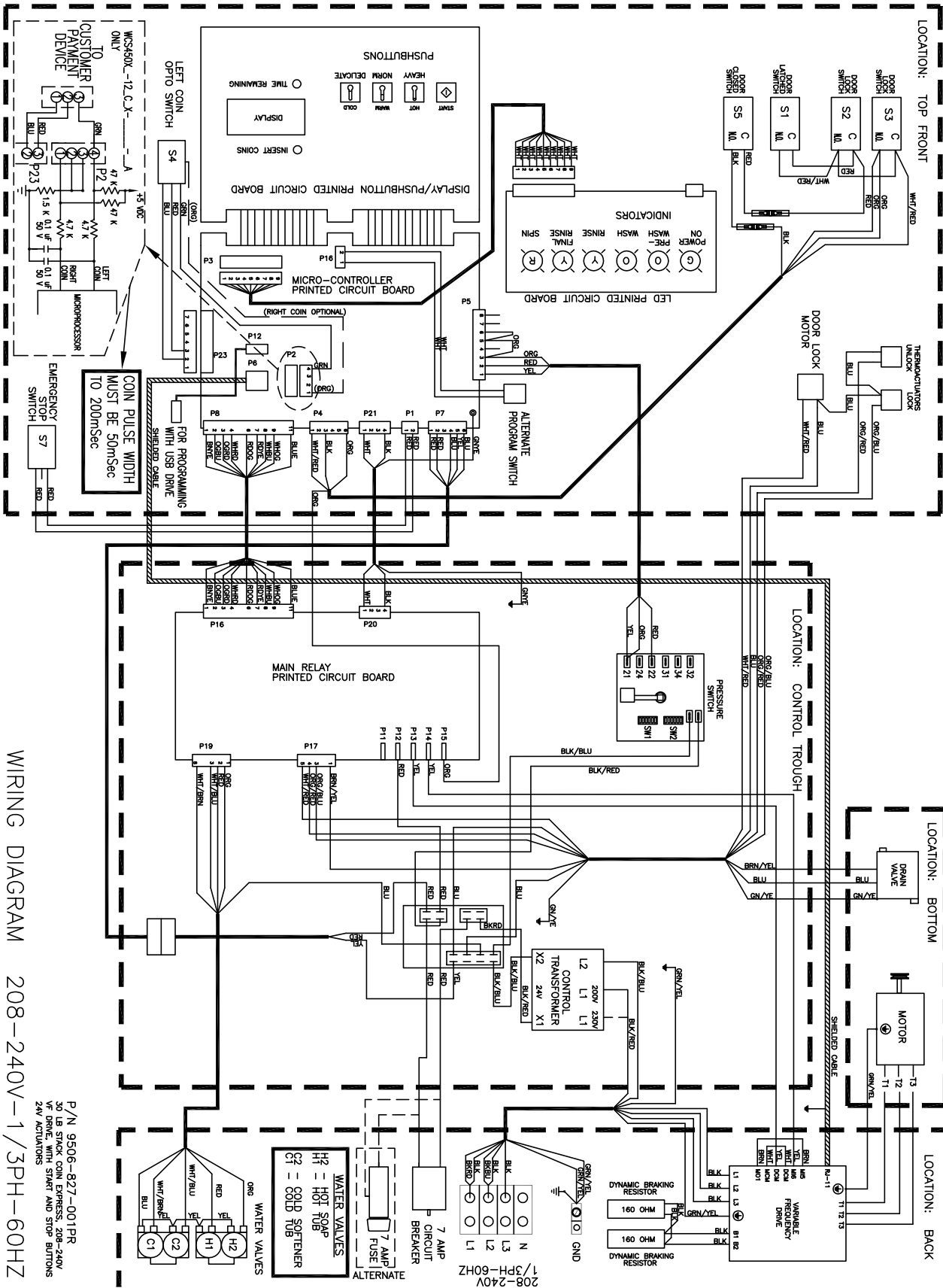

WIRING DIAGRAM 208-240V-1/3PH-60HZ

P/N 9506-827-001PR
 30 LB STACK COIN EXPRESS, 208-240V
 VFD DRIVE, WITH START AND STOP BUTTONS
 24V ACTUATORS

Wiring Diagram for 60hz Coin Washer

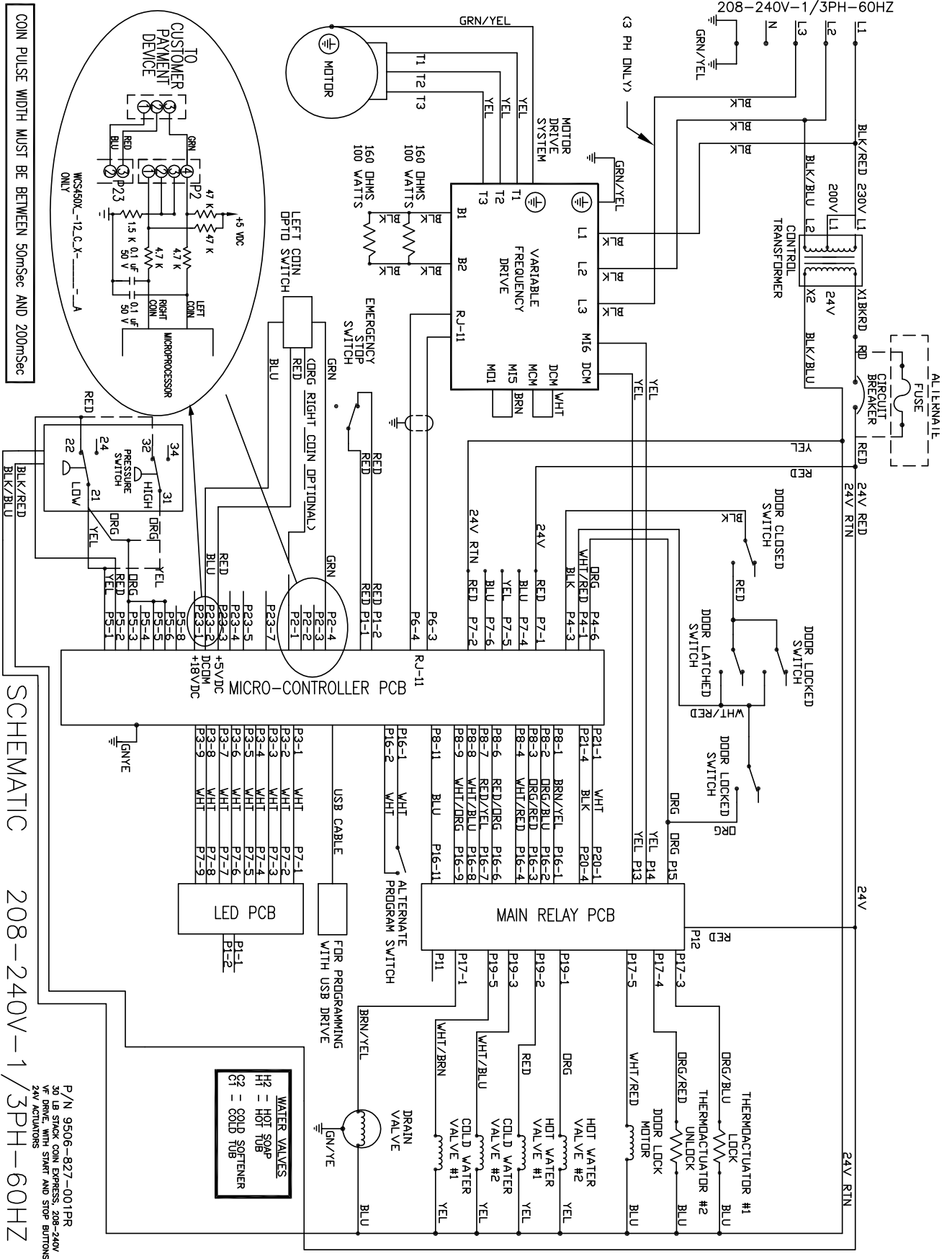

CON PULSE WIDTH MUST BE BETWEEN 50mSec AND 200mSec

SCHEMATIC 208-240V-1/3PH-60HZ

P/N 9506-827-001PR
 30 LB STACK COIN EXPRESS, 208-240V
 1/4" DRIVE, WITH START AND STOP BUTTONS
 2PH ACTUATORS

Section 10:

50 Hz Washer

Models

Parts in this section used only in these models. All other parts are same as standard 60 Hz pages.

Coin Handling

KEY	Part Description		QTY
*	Wiringlabel-Diagram/Schematic -39	9506-829-001	1
*	Wiringlabel-Diagram/Schematic -12	9506-827-001	1
1	Elect. Acceptor for C series SWD, Malaysia, Singapore, Thailand	9732-303-001	
	Elect. Acceptor for C series SWD, Swiss, Euro	9732-303-002	
	Elect. Acceptor for C series SWD, Chile, Mexico	9732-303-003	
	Elect. Acceptor for C series SWD, US, CAN	9732-303-004	
	Elect. Acceptor for C series SWD, Japan, Taiwan, Korea	9732-303-005	



Wiring Schematic for 50hz Washer -39

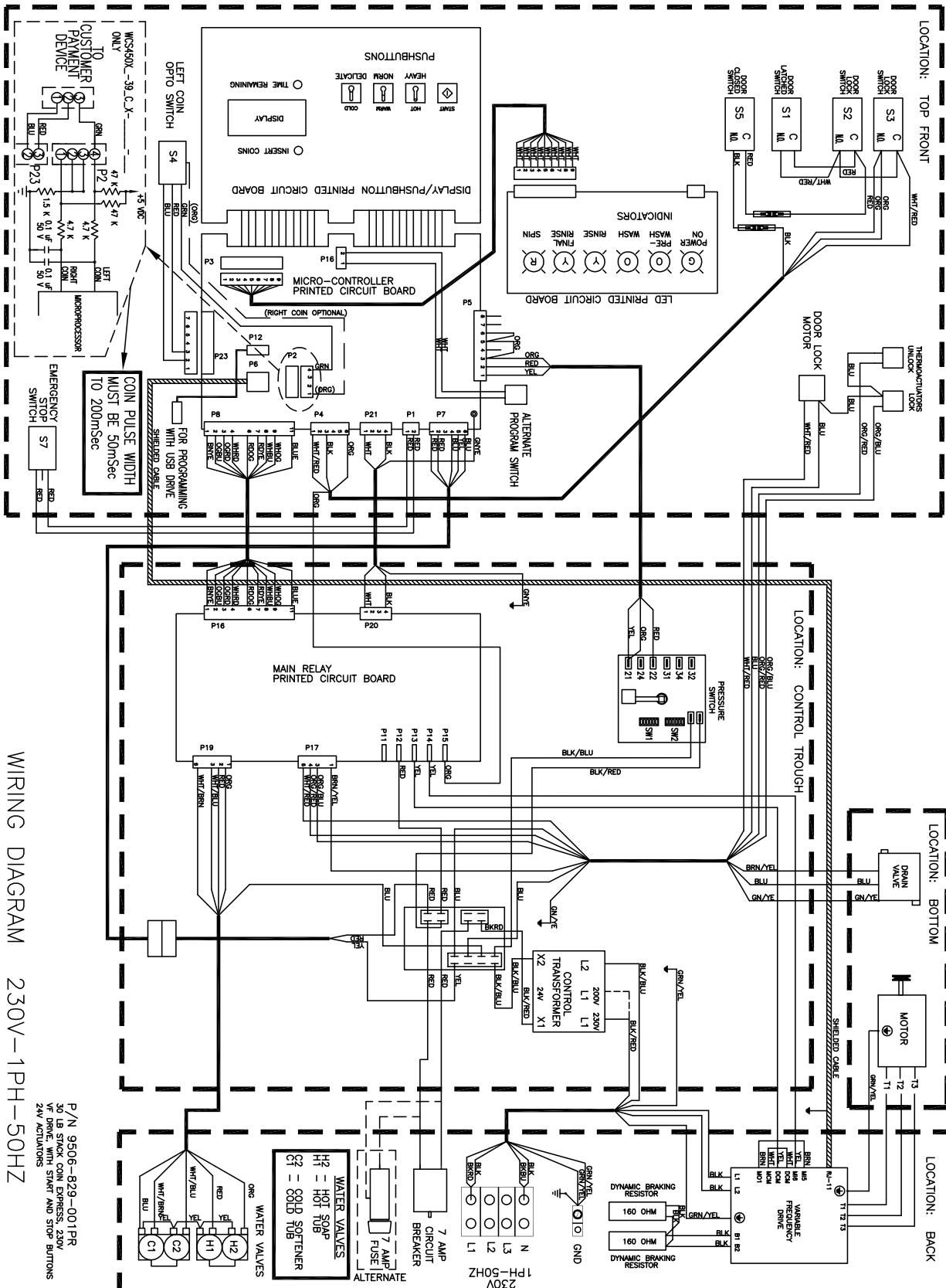

WIRING DIAGRAM 230V-1PH-50HZ

P/N 9506-829-001PR
 30 LB STACK COIN EXPRESS, 230V
 VFD DRIVE, WITH START AND STOP BUTTONS
 24V ACTUATORS

Wiring Diagram for 50hz Washer -39

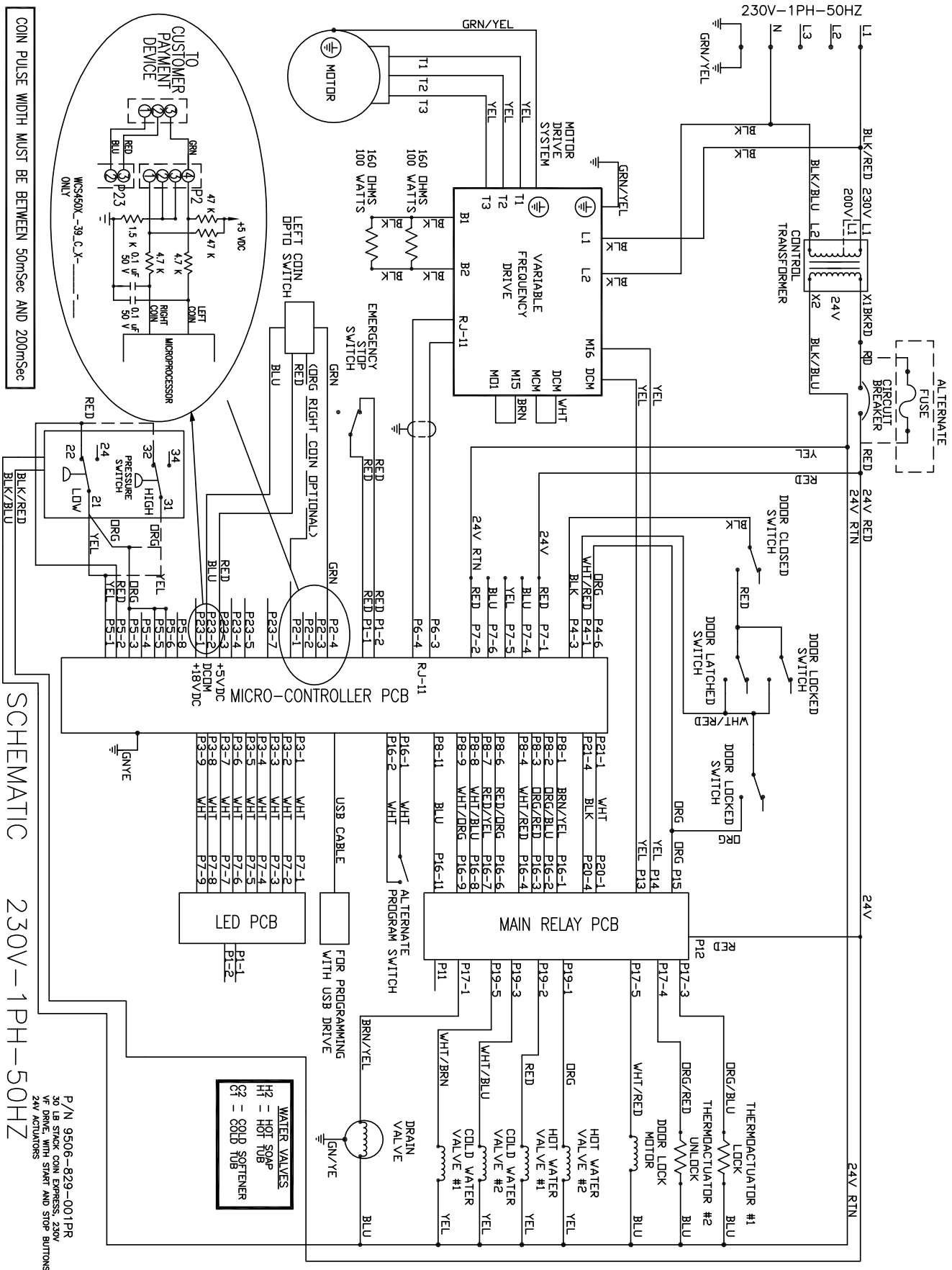

SCHEMATIC

230V-1PH-50HZ

COIN PULSE WIDTH MUST BE BETWEEN 50mSec AND 200mSec

P/N 9506-829-001PR
 1/18 START PRESSURE
 1/18 START PRESSURE
 24V ACTUATORS

WATER VALVES
 H2 - HOT SOAP
 H1 - HOT TUB
 C2 - COLD SOAP
 C1 - COLD TUB

Section 11:

Maintenance

Washer and Dryer

Preventative Maintenance

Daily

- Step 1:** Clean the lint screen free of lint and other debris. Use a soft brush and Hot water if necessary.
- Step 2:** Check the lint screen for tears. Replace if necessary.
- Step 3:** Clean lint from the lint screen compartment.
- Step 4:** Inspect felt seal on lint screen assembly, replace if needed.

Monthly

- Step 1:** Remove lint accumulation from the end bells of the motor.
- Step 2:** Remove lint accumulation from front control area.
- Step 3:** Remove lint and dirt accumulation from the top of the dryer and all areas above, below, and around the burners and burner housing. Failure to keep this portion of the dryer clean can lead to a build-up of lint creating a fire hazard.
- Step 4:** Remove and clean coin acceptors. (Vended Models Only)

Quarterly

- Step 1:** Check the belts for looseness, wear, or fraying.
- Step 2:** Inspect the gasket of the door glass for excessive wear.
- Step 3:** Check tightness of all fasteners holding parts to support channel.
- Step 4:** Check tightness of all set screws.
- Step 5:** Remove the air flow switch assembly and check the tumbler thru-bolts for tightness.
- Step 6:** Apply a few drops of oil to pivot pins and the tension arms where in contact with each other.

Semi-Annually

- Step 1:** Remove and clean the main burners.
- Step 2:** Remove all orifices and examine for dirt and hole obstruction.
- Step 3:** Remove all lint accumulation. Remove the front panel and the lint screen housing and remove lint accumulation.

Annually

- Step 1:** Check the intermediate pulley bearings for wear.
- Step 2:** Check and remove any lint accumulation from the exhaust system including recirculation chambers if applicable.
- Step 3:** Grease the bearings and the shaft of the intermediate pulley. Use an Alemite grease gun and Molykote BR2-S grease. (Where applicable)

Preventative Maintenance

Daily

- Step 1:** Check that the loading door remains securely locked and cannot be opened during an entire cycle.
- Step 2:** Clean the top, front, and sides of the cabinet to remove residue.
- Step 3:** Clean the soap dispenser and lid and check that all dispenser mounting screws are in-place and tight.
- Step 4:** Check the loading door for leaks. Clean the door seal of all foreign matter.
- Step 5:** Leave the loading door open to aerate the washer when not in use.

Quarterly

- Step 1:** Make sure the washer is inoperative by switching off the main power supply.
- Step 2:** Check the V-belts for wear and proper tension.
- Step 3:** Clean lint and other foreign matter from around motor.
- Step 4:** Check all water connections for leaks.
- Step 5:** Check the drain valve for leaking and that it opens properly.
- Step 6:** Wipe and clean the inside of the washer and check that all electrical components are free of moisture and dust.
- Step 7:** Remove and clean water inlet hose filters. Replace if necessary.
- Step 8:** Check anchor bolts. Retighten if necessary.

