



Section 5:

Dryer Parts Data

SWD

Dryer Cabinet Group

	Description	T-20 SWD	QTY
1	Panel Assy., Front- Upper (SS)	9989-591-001	1
*	Insulation Front Panel, half moon (top)	9277-064-001	1
*	Insulation Front Panel, half moon (bottom)	9277-064-002	1
2	Screw, FLHDCR, 10B x 1 3/4	9545-008-014	4
3	Washer, Finish, #10	8641-585-001	4
*	Nut, Spring	8640-399-001	4
*	Hinge ,Backup Plate	9982-392-001	1
*	Screw, Countersink, 10-32X 1/2	9545-012-003	2
4	Strap, Hinge (SS/Black)	9544-074-002	2
*	Screw, Hinge to Panel	9545-012-028	4
*	Door Assy., Loading Complete-Chrome/BLK/SS	9960-315-002	1
5	Door Assy., Loading-Chrome(ring only)	9960-314-003	1
6	Plate Assy., Hinge (SS)	9982-393-001	1
*	Screw, Hinge to Door	9545-012-015	4
*	Nut, Hinge to Door	8640-413-002	4
*	Cover, Hinge Plate	9074-377-002	1
*	Screw, Phillips-10B x 3/8	9545-008-010	2
7	Glass, Door	9212-002-005	1
8	Gasket, Glass Black	9206-413-003	1
*	Support, Door Glass	9548-117-000	1
*	Tool Install Dryer Door Gasket	8545-064-001	1
9	Gasket, Outer Rim Black	9206-420-006	1
10	Handle, Loading Door	9244-092-001	1
*	Screw, Handle 1/4-20 x 3/8	9545-018-017	2
11	Stud, Door Catch, 7/8	9531-033-002	1
12	Nut, Hex	8640-413-001	1
13	Nut, Acorn	8640-413-003	1
14	Catch, Loading Door	9086-015-002	1
15	Pop Rivet for mtg. catch	8638-190-009	2
16	Screw, Door to Hinge Strap (Special Black Type)	9545-052-001	1
17	Washer, Fiber	8641-436-003	1
18	Acceptor, Coin	9021-094-001	1
*	Retainer, Coin Acceptor	9486-145-001	2
19	Screw, 4Bx5/8ss, T10	9545-053-002	4
*	Switch, Optical	9801-099-001	1
*	Cabinet Touch Up Paint (White)	9472-001-013	1

Cabinet Group

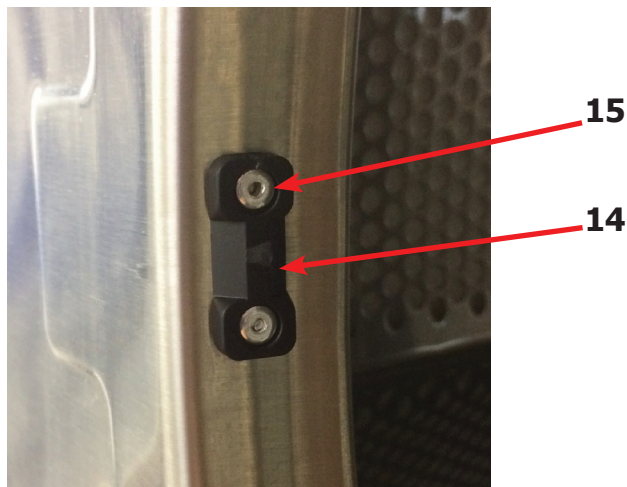
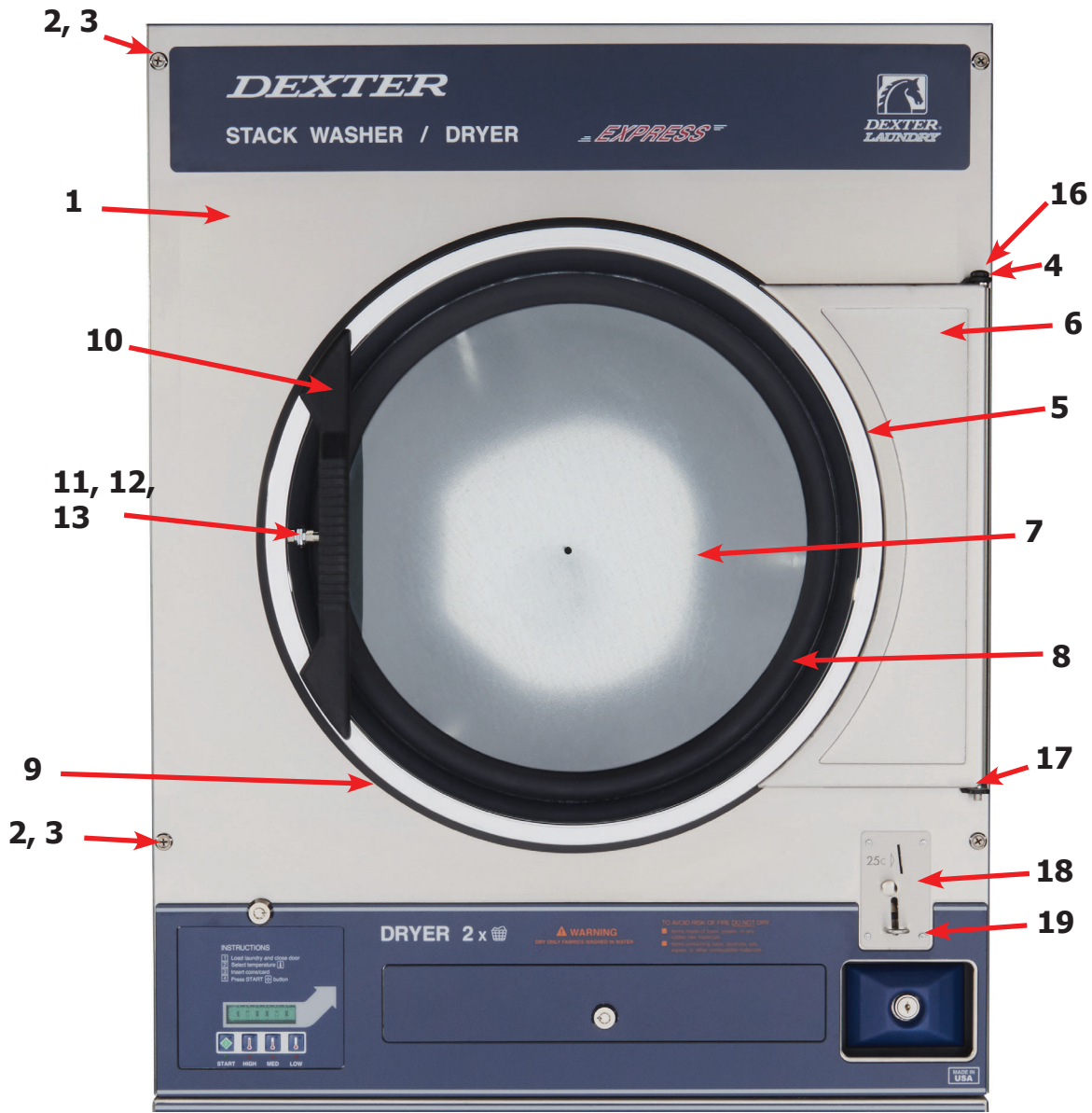

Dryer Cabinet Group

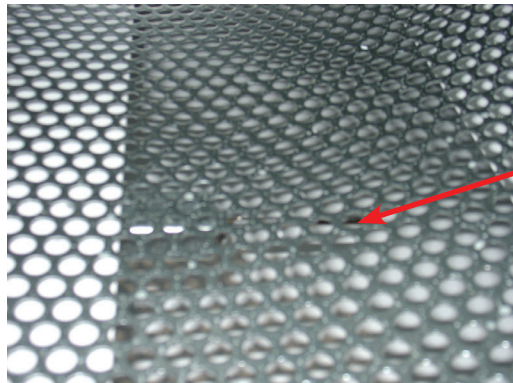

Cabinet Group Continued

Key	Description	T-30 SWD	QTY
20	Escutcheon, SWD, Dryer Coin	9994-038-001	1
21	Trim, Overlay Blue	9435-051-002	1
21	Trim, Overlay Black	9435-051-001	1
*	Screw, #4-40 x 3/16	9545-020-009	13
22	Nameplate Stack Dryer Express Blue	9412-240-002	1
22	Nameplate Stack Dryer Express Black	9412-240-001	1
*	Lint Drawer Assembly Blue	9866-008-001	1
*	Lint Drawer Assembly Black	9866-008-003	1
*	Drawer, Front	9974-016-002	1
*	Washer, Flat, #10	8641-581-006	2
*	Washer, Curved-Spring	8641-569-004	2
*	Nut, 10-32	8640-413-007	2
23	Overlay Trim, Lint Drwr-Blue	9435-053-002	1
23	Overlay Trim, Lint Drwr-Black	9435-053-001	1
*	Felt Seal (back of lint screen assembly)	9532-142-001	1
*	Lint Screen Assembly ONLY (no front)	9805-037-001	1
*	Replaceable Lint Screen Only	9555-057-011	1
24	Lock and Key, Lint Drawer	8650-012-004	1
*	Key 6101 only	6292-006-010	1
*	Cam, Lock	9095-043-001	1
*	Lint Screen Strap Hold Down Screws 10Bx 1/4	9545-008-001	12
25	Controls Assy, 24VAC, Blue	9857-199-002	1
25	Controls Assy, 24VAC, Black	9857-199-004	1
*	Harness, Electronic Control	9627-913-004	1
26	Lock and Key, Control	8650-012-003	1
*	Cam, Lock	9095-041-001	1
*	Washer-flat,shim	8641-581-010	2
*	Washer-flat	8641-581-041	1
*	Key only 6324	6292-006-007	1
27	Sensor Temp Control	9501-006-001	1
*	Harness, Main	9627-913-004	1
*	Wire Nut Connector Grey	8640-276-002	2
*	Cover, Cabinet (Top)	9074-374-001	1
*	Insulation Cabinet Cover	9277-041-028	1
*	Insulation-side Panel	9277-041-027	2
*	Stack Dryer Trunnion Puller	9732-243-002	1
*	Vault, Coin Box	9942-028-005	1
*	Screws, Mounting-Coin Vault	9545-008-024	2
28	Coin Box Assy, Small Blue	9807-099-001	1
28	Coin Box Assy, Small Black	9807-099-003	1
*	Nut, Elastic Stop	8640-413-004	*

Dryer Back Panels and Guards

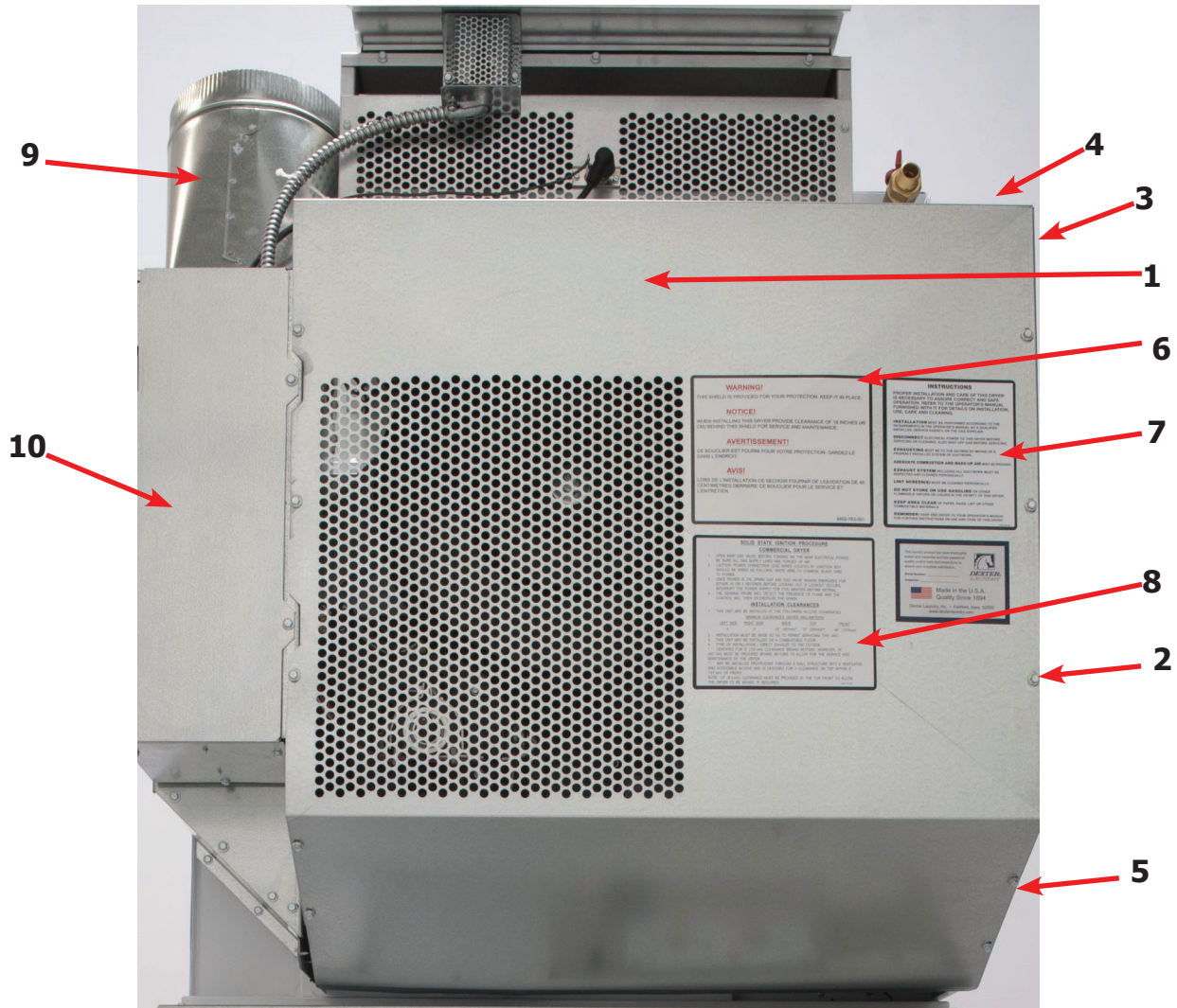

Key	Description	Part Number	Qty
1	Guard, Drive	9208-133-001	1
2	Screw, 10AB x 3/8	9545-008-024	20
3	Panel, Drive Guard,	9208-131-001	1
4	Guard-Small, upper	9208-134-001	1
5	Guard-side,lower	9208-132-001	1
6	Warning, Label	8502-763-001	1
7	Label, Instructions	8502-645-001	1
8	Lighting and Clearance, Label	8527-112-001	1
9	Duct, Transition	9109-127-001	1
10	Door, Cover-Control Box	9108-141-001	1
*	Cabinet, Cover	9074-374-001	1
*	Insulation	9277-041-028	1
*	Wiring Diagram & Schematic	9506-808-001	1
*	6" Slide Open Clean Out Duct (Optional)	9973-035-001	1

Air Flow Switch Assembly

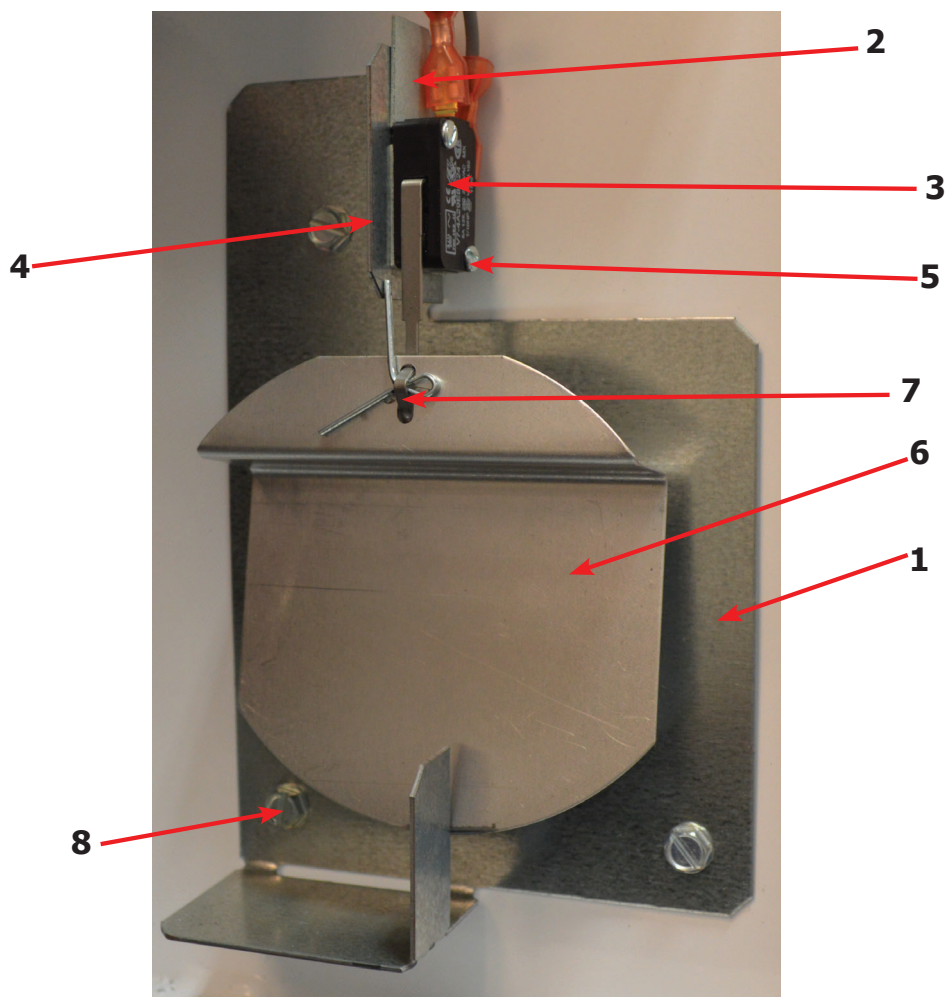

Key	Description	T-20 SWD	QTY
*	Air Flow switch Assy	9801-095-001	2
1	Bracket-Airflow switch	9029-174-001	2
2	Shield-Switch	9550-169-003	2
3	Switch-Micro	9539-461-009	2
4	Nut-Twin, 4-40	8640-401-001	2
5	Screw-.625, 4-40	9545-020-001	2
6	Actuator-Air Flow Switch	9008-007-001	2
7	Pin-Cotter, .09375x.75	9451-169-002	2
8	Screw, 10AB x 1/4	9545-008-001	3
*	Wireasy-brn,#13,34"	8220-063-032	1
*	Wireasy-org,#14,24"	8220-095-040	1
*	Wireasy-vio,54"	8220-103-001	1

Dryer Burner Housing Group

Key	Description	T-20 SWD	QTY
*	Housing Assembly, Burner (All sheet metal parts not listed)	9803-228-003	1
1	Panel, Back Burner Housing	9454-990-001	1
2	Screw, 10B X 1/4"	9545-008-001	4
3	Angle, Burner Support	9003-220-001	1
*	Screw, 10B x 3/8"	9545-008-006	2
4	Burner, Main	9048-023-001	2
*	Screw 10AB x 3/8"	9545-008-006	2
5	Electrode-ignition	9875-002-003	1
6	Screw, Electrode Mtg 8B x 1/4"	9545-045-001	2
7	Valve, Gas Shut Off (Optional)	9379-196-001	1
8	Pipe Nipple, 1/2 x 4 1/2, BLK	8655-073-008	1
9	Elbow, 1/2 x 90, BLK	8615-104-037	1
10	Pipe Nipple, 1/2 x 3 1/2, BLK	8655-073-047	1
11	Control Assy, Gas	9857-192-001	1
*	Wireasy-yel,47/8"	8220-001-466	1
12	Manifold, Assy	9381-012-001	1
*	Orifice, Burner-Natural #40	9425-069-030	2
*	Orifice, Burner-LP #54	9425-069-031	2
13	Bracket, Manifold	9029-175-001	2
14	Pipe Plug in end of Burner Manifold	8615-104-038	1
*	Screw, 10AB x 3/8"	9545-008-006	2
15	Bracket, High Limit Thermostat	9029-192-001	1
16	Thermostat, Hi-Limit	9576-203-002	1
*	Spacer, Hi-Limit	9538-142-001	2
*	Screw 8B x 3/4"	9545-045-007	2
17	Cover, Hi-Limit Stat	9074-329-001	1
*	Screw, 10AB x 3/8"	9545-008-006	2
18	Thermostat, Safety Shutoff	9576-207-006	1
19	Screw, 10AB x 3/8"	9545-008-006	2
*	Control, Ignition Fenwall (3 trybox)	9857-182-001	1
*	Kit, LP Conversion 20Lb Stack Kit	9732-102-034	1

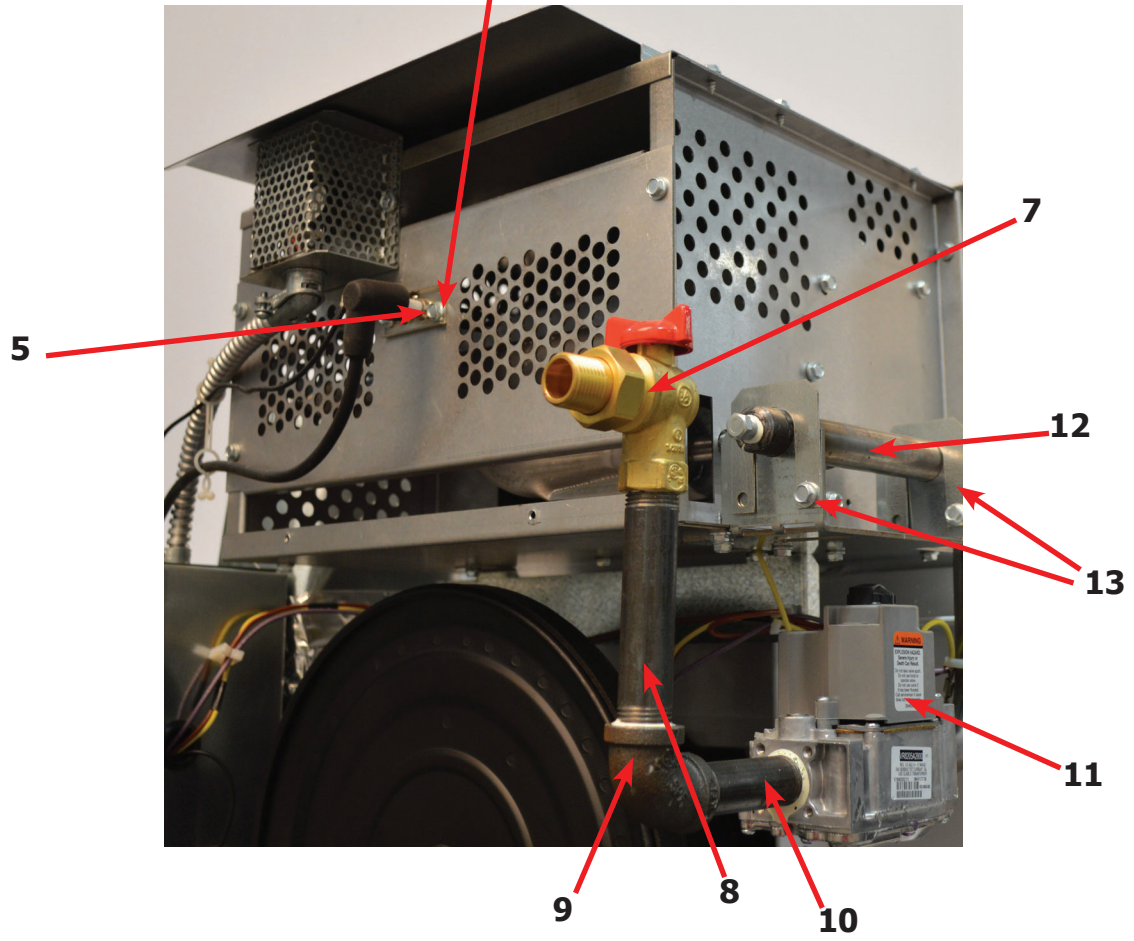
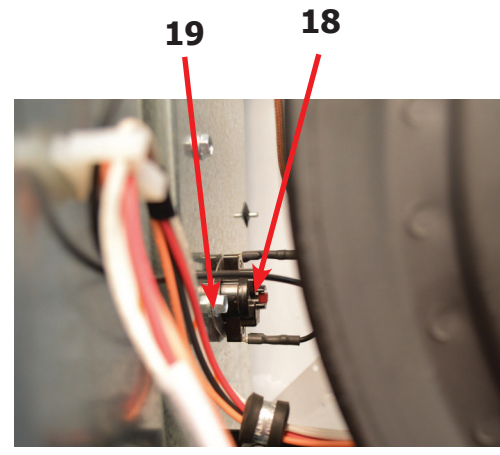
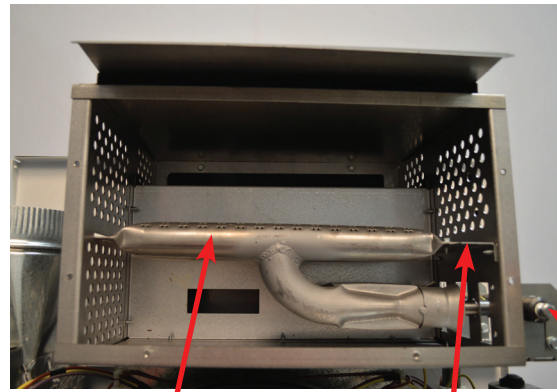
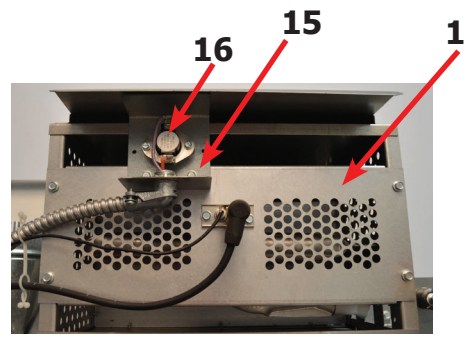
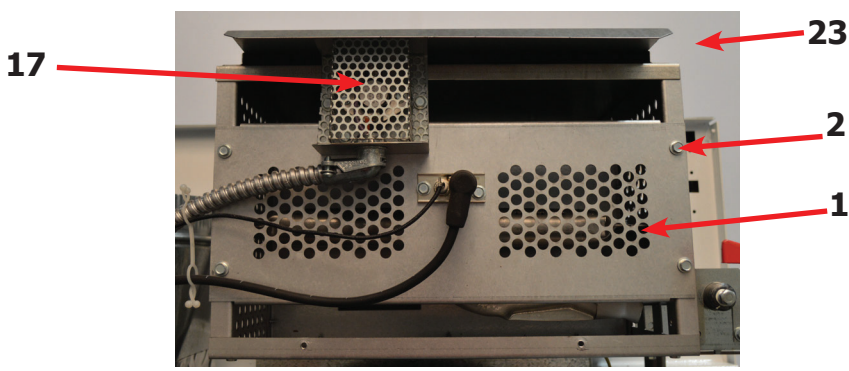

Bearing Housing Group

Key	Description	T-20 SWD	QTY
	Bearing Housing Complete Assy (Includes bearings & Spacer)	9803-160-003	1
1	Housing, Bearing	9241-161-002	1
*	Spacer, Bearing	9538-139-002	1
2	Bearing, Ball, Front & Rear	9036-130-001	2
3	Screw-Wizlock, 3/8-24x3/4	9545-049-002	4
4	Nut, 5/16-18	8640-400-002	4
5	Screw, 3/8-24x1	9545-049-001	2
6	Nut, 3/8-24	8640-415-002	2

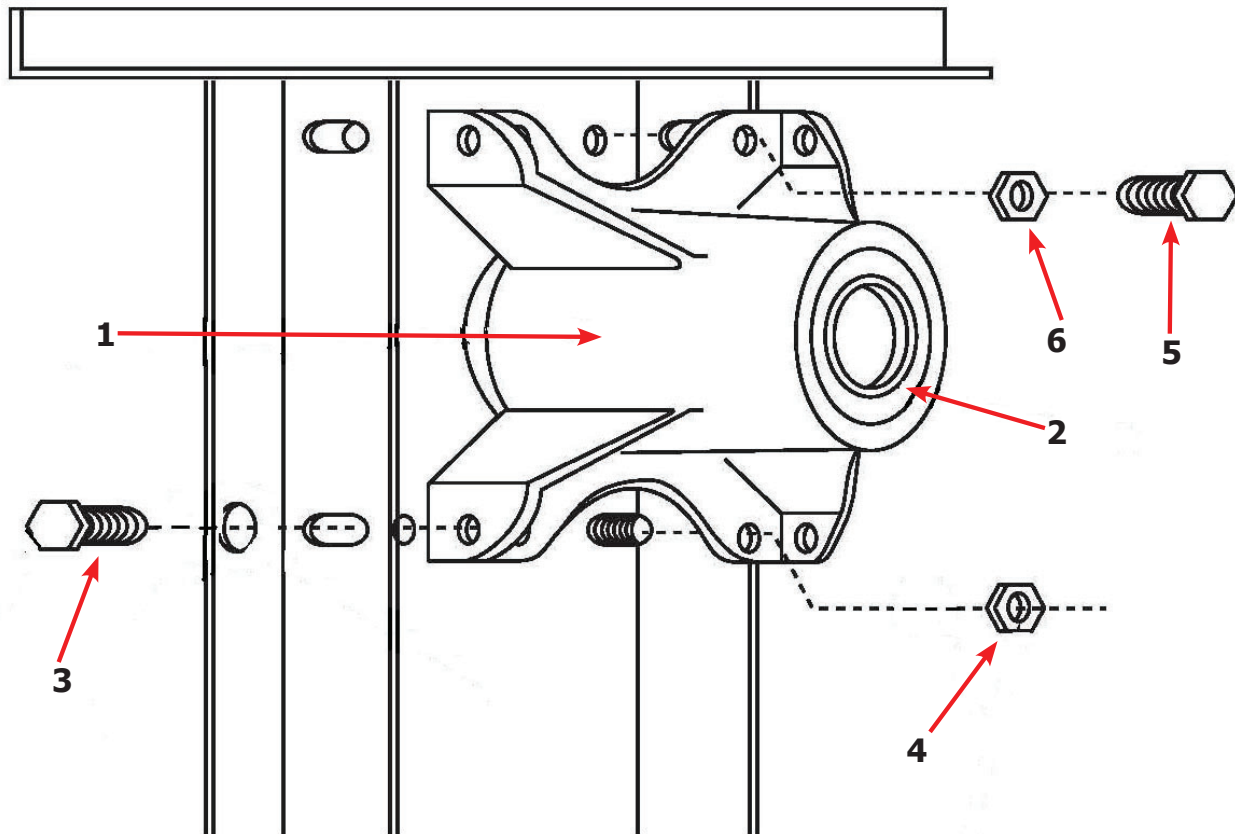
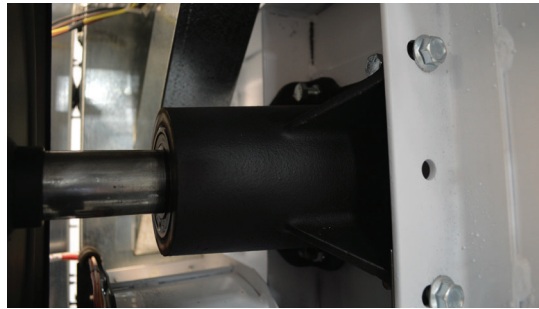

Tumbler Group

Key	Description	T-20 SWD	QTY
*	Tumbler Assy Complete W/Spider (GALV)	9848-156-001	1
1	Tumbler Assy (Galvanized)	9848-155-001	1
*	Tumbler Assy Complete W/Spider (SS & Galv front)	9848-156-002	1
1	Tumbler Assy (Stainless Galvanized front)	9848-155-002	1
2	Rod, Tumbler	9497-019-004	3
3	Washer, Special	8641-554-001	3
4	Shim	9552-013-003	AR
5	Spider Assy	9568-018-001	1
6	Nut, Wiz Lock	8640-415-004	3
7	Spacer-Shaft	9538-164-001	1
8	Tolerance Ring	9487-234-005	1
9	Pulley, Driven	9908-052-002	1
10	Washer -Flat 1/2	8641-581-026	1
11	LockWasher - IntTooth, 1"	8641-582-016	1
12	Screw, 1/2-13x1 1/4	9545-017-009	1
*	Belt, Drive	9040-073-013	2

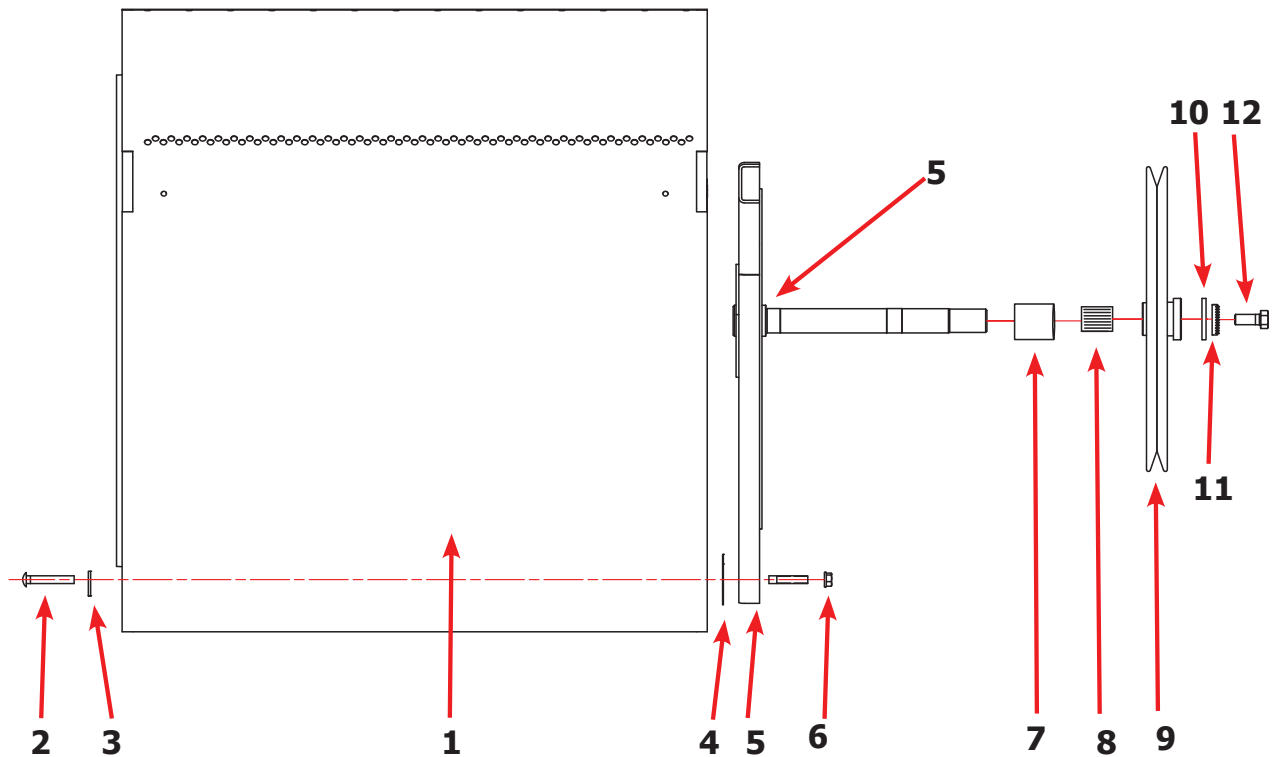

	Description	T-20 SWD	QTY
*	Switch Assy, Air Flow	9801-095-001	1
1	Switch, Air Flow	9539-461-009	1
2	Bracket, Switch- Air Flow	9029-174-001	1
3	Actuator, Switch	9008-007-001	1
4	Pin, Cotter	9451-169-002	1
5	Screw 4-40 x 5/8"	9545-020-001	2
*	Nut, Special Twin .#4-40	8640-401-001	1
*	Shield, Switch	9550-169-003	1
*	Screw 10 Bx 1/4"	9545-008-001	3
6	Motor, Drive	9376-332-001	1
*	Tumble Capacitor	5191-108-005	1
*	Start Capacitor	5191-109-005	1
*	Pulley-motor,60hz	9453-185-001	1
*	Screw-set,5/16-18x1/2	9545-028-013	1
7	Plate, Motor Mtg	9982-390-002	1
*	Bolt 3/8" - 16 x 3/4"	9545-029-008	1
*	Lockwash Spring 3/8	8641-582-003	1
8	Screw, Motor to Plate Screw-hxflgwhzlk,5/16-18x5/8	9545-014-004	4
*	Nut-hextwinwhzlk,5/16-18	8640-400-003	4
9	Nut 1/4x20 Motor Plate to Cabinet	8640-414-007	7
10	Clamp-cable,3/4	8654-125-004	2
*	Screw-hxhdsldmach,12abx1/2	9545-048-001	2
11	SupportAssy, Intermed. Pulley	9991-053-002	1
12	Bolt, Rd Hd 3/8-16 x 1 1/4	9545-029-010	3
13	Bolt, 3/8-16 x 1 1/2	9545-029-012	1
12	Nut Flange Wizioclock 3/8" - 16	8640-415-004	3
*	Washer, Flat	8641-581-035	1
14	Arm Assy-Tension, Complete	9861-022-001	1
*	Washer, Flat	8641-581-035	1

Rear View Photos

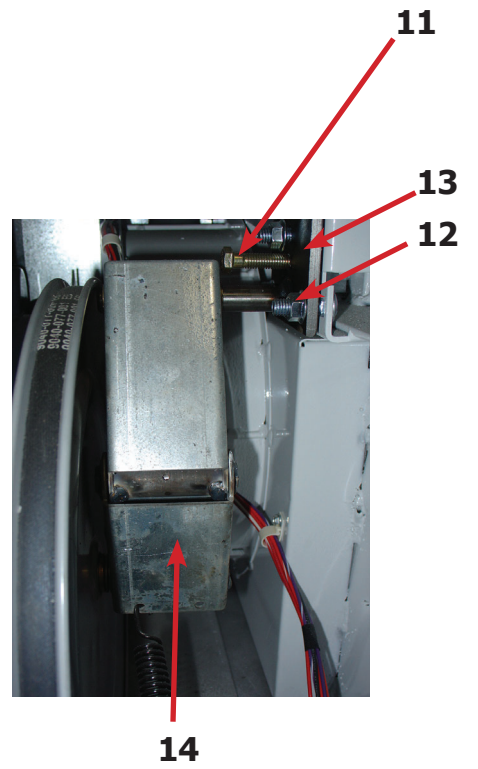
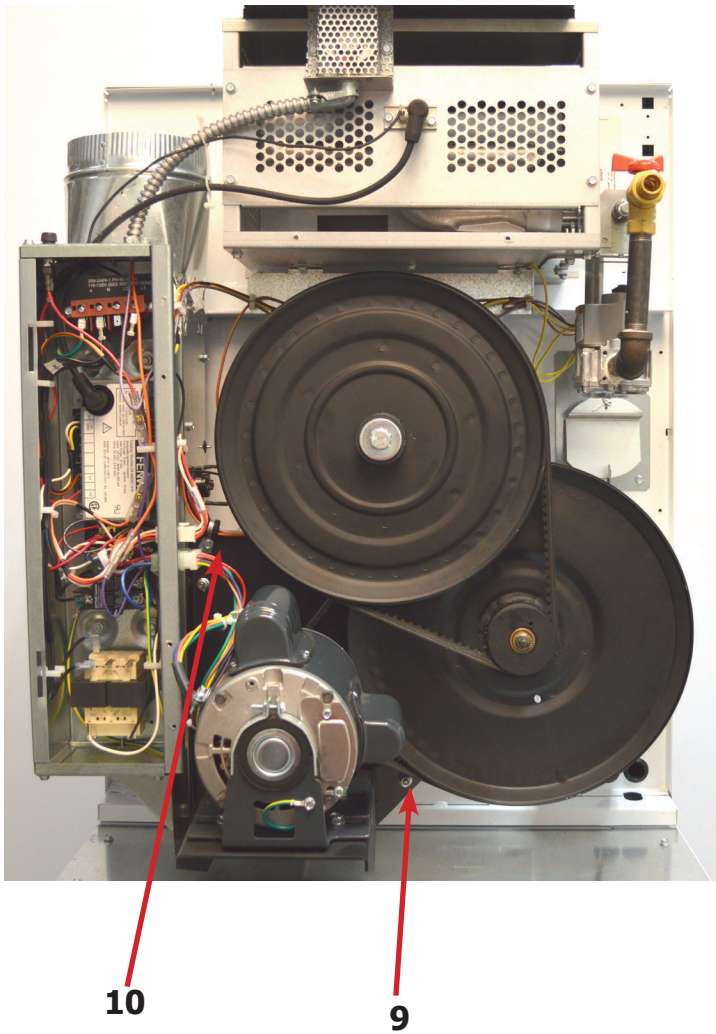
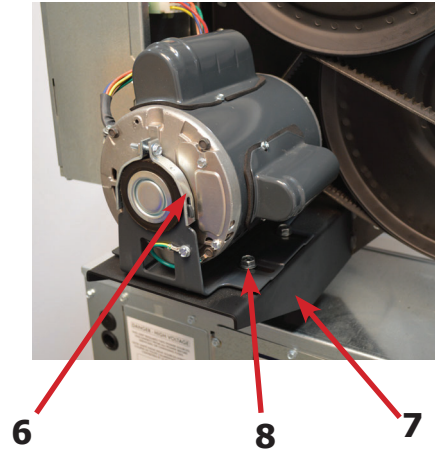
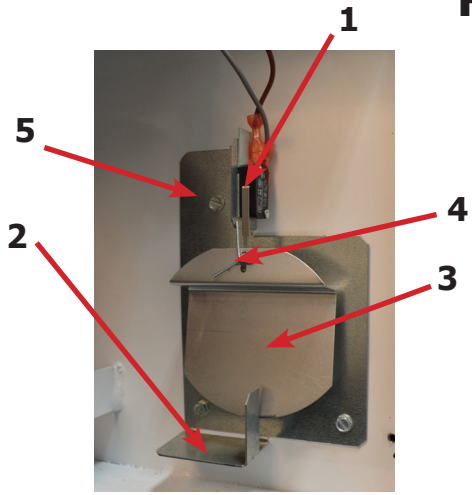

	Description	T-20 SWD	QTY
14	Arm Assy-Tension, Complete	9861-022-001	1
*	Washer, Flat	8641-581-035	1
15	Ring-Retaining	9487-200-003	1
16	Pulley Assy, Intermediate with bronze flange bearing	9908-053-003	1
*	Bearing - Bronze Flange	9036-145-002	1
*	Spacer-Shaft (See Tumbler Group for Expanded View)	9538-164-001	1
*	Tolerance Ring	9487-234-005	1
17	Pulley, Driven	9908-052-002	1
18	Washer -Flat	8641-581-026	1
18	LockWasher - IntTooth, 1/2"	8641-582-016	1
18	Screw, 1/2-13x1 1/4	9545-017-009	1
19	Belt, Drive- Motor	9040-076-012	1
20	Belt, Drive- Tumbler	9040-073-013	1
21	Spring, Tension	9534-319-002	1
22	Chain, Tension	9099-012-011	1
23	Hook, Tension	9248-022-002	1
*	Damper Inside Duct Exhaust	9125-009-001	1
24	Pin, Damper Hinge	9451-146-007	1
*	Box-duct.lower	9041-113-001	1
*	Nut, Spring	8520-141-000	2
*	Screw #10B x 1/2	9545-008-026	3
*	Cover Duct Upper	9074-372-001	1
*	Base Duct	9047-121-001	1
*	Screw 10ABx 3/8"	9545-008-024	40
26	Impeller, W/Set Screws	9278-045-001	1
27	Pulley, Motor	9453-185-001	1
28	Bracket for Wire Harness Under Burner Housing	9029-305-001	1

Rear View Photos

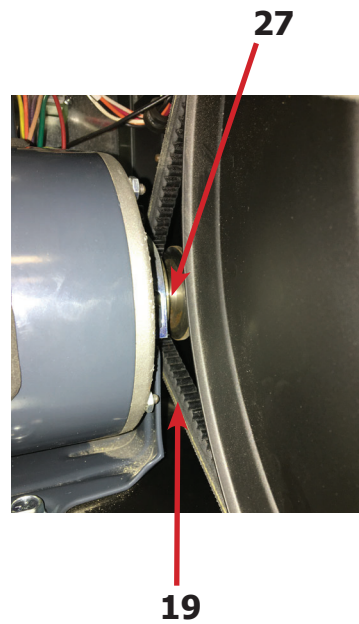
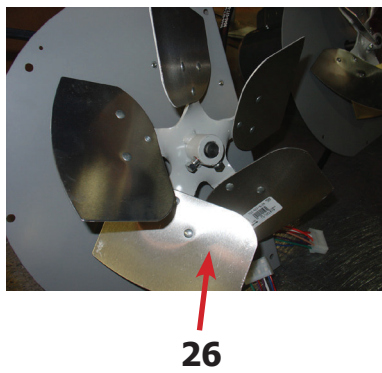
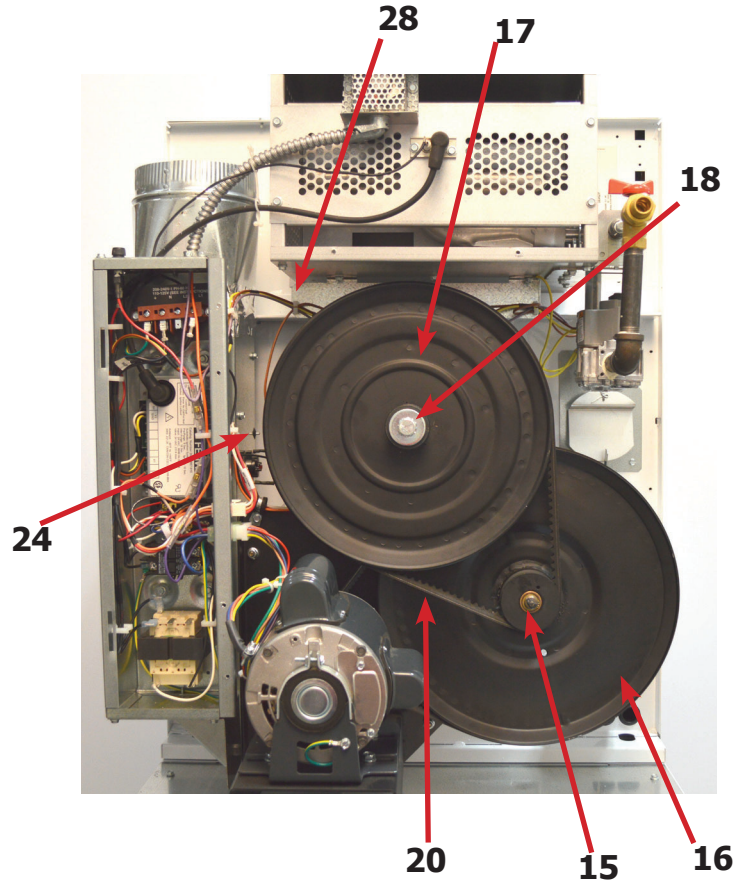
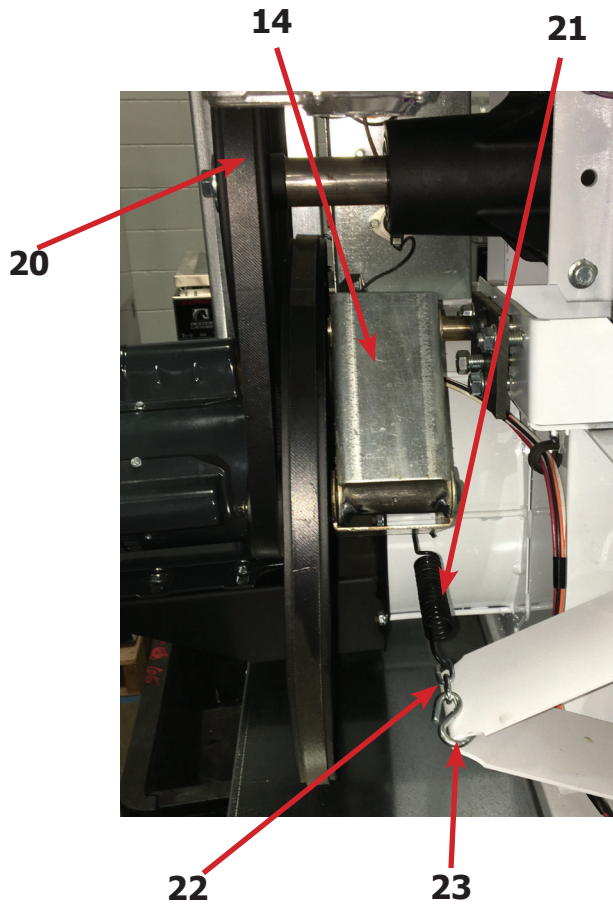

Control Assembly Group

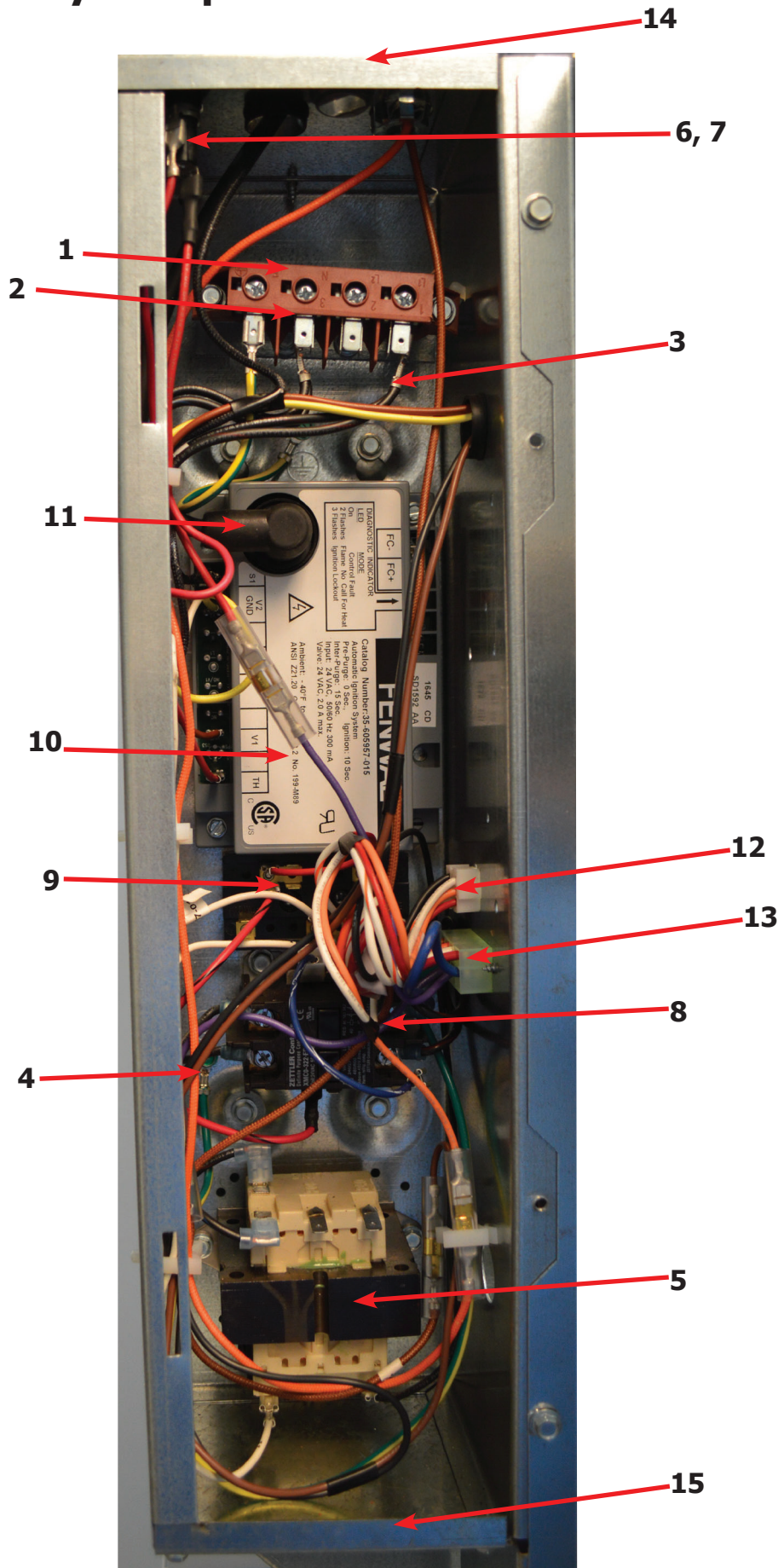

Control Assembly Group

Key	Description	T-20 SWD	QTY
*	Control, Rear	9857-229-001	1
*	Bracket, Terminal Block Power	9029-202-001	1
1	Strip, Terminal Marker	9558-029-003	1
2	Terminal-Block, Power, 4 Pole	9897-035-001	1
*	Screw, 10AB x 3/8"	9545-008-024	6
3	Harness Assembly-Power Main Fork, Upper	9627-859-007	1
4	Wire Assembly-Ground, GRN/YEL, 7"	8220-137-002	1
*	Lock Washer, Ext tooth #10	8641-582-006	1
*	Screw, 10-32 x 1/2"	9545-008-027	1
5	Transformer, 208/240/60Hz. 24/120VA	8711-007-002	1
*	Screw, 10AB x 3/8"	9545-008-024	2
6	Fuse Holder Assembly	9200-001-002	1
7	Fuse, 1.5Amp/250V-Fast Acting	8636-018-001	1
8	Relay, Motor, 30Amp 24VAC	5192-299-002	1
*	Screw, Phillips, 8AB x 1/2"	9545-045-012	2
9	Terminal Block, Power	9897-026-001	1
*	Screw, Phillips, 8AB x 1/2"	9545-045-012	2
*	Harness-Assembly, Low Voltage, Upper	9627-867-011	1
10	Ignition Module	9857-182-001	1
*	Screw, 10AB x 3/4"	9545-008-018	2
11	Wire Assembly, High Voltage	9631-403-009	1
*	Door-Control Box	9108-141-001	1
*	Screw, 10AB x 3/8"	9545-008-024	3
12	Harness, Main (Internal Box)	9627-863-003	1
*	Harness Main Extension (External Box)	9627-913-004	1
13	Harness Motor	9627-864-007	1
14	Control Box Panel Upper	9454-943-001	1
15	Control Box Panel Lower	9454-944-001	1
*	Control Box Wrapper	9636-216-001	1
*	Wire Red/Black 8"	8220-062-047	1
*	Wire White #11, 14"	8220-062-038	1
*	Wire-Blue/White 5.5"	8220-062-026	1
*	Wire Black/Red #9 9"	8220-146-001	1

Door Switch Group

Key	Description	T-20 SWD	QTY
1	Door Switches	9539-487-001	2
2	Bracket-Mounting lint tray switch	9029-297-001	1
3	Conduit-Wire	6068-049-001	1
*	Grommet Wire 1/2 i.d.	9029-089-001	1

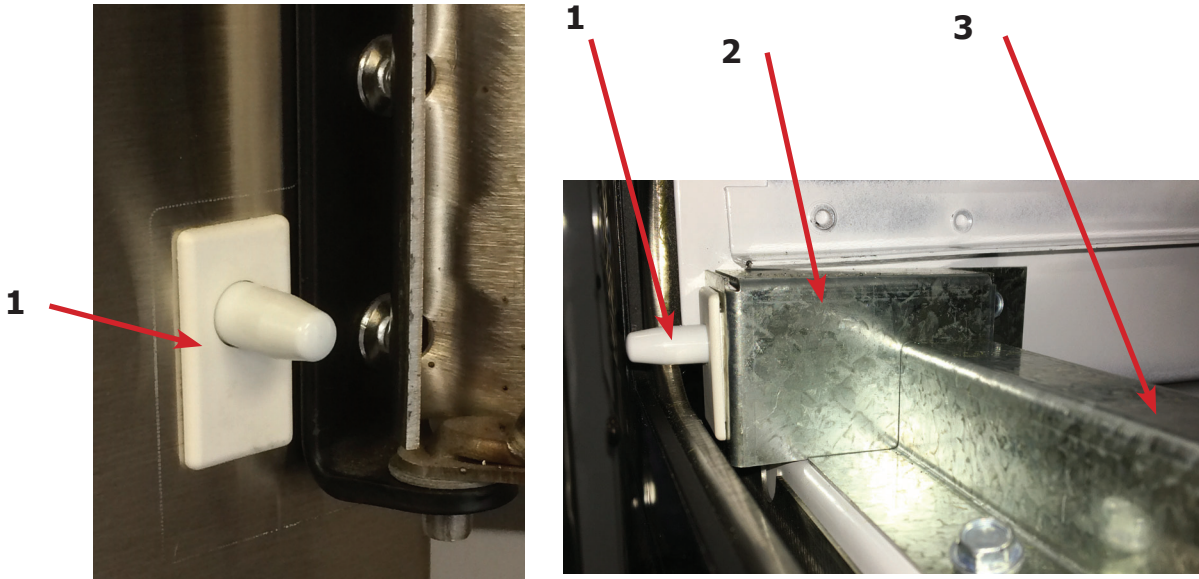

Hinge Plate Cover

Key	Description	T-20 SWD	QTY
1	Cover-Hinge, Black	9074-377-002	1
2	Screw-TRHDCR, 10B x 3/8, Black	9545-008-010	2

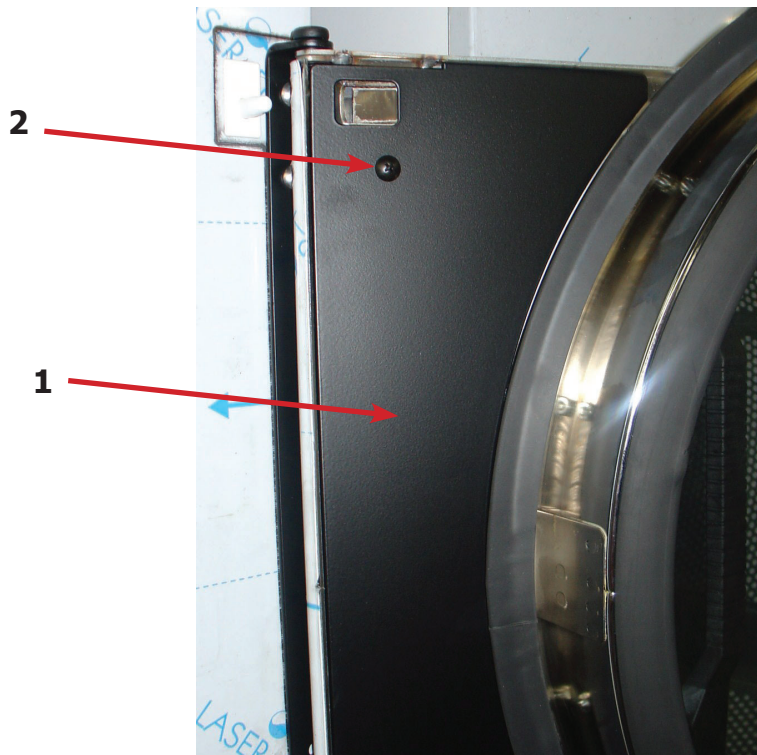

Wiring Diagram 60Hz

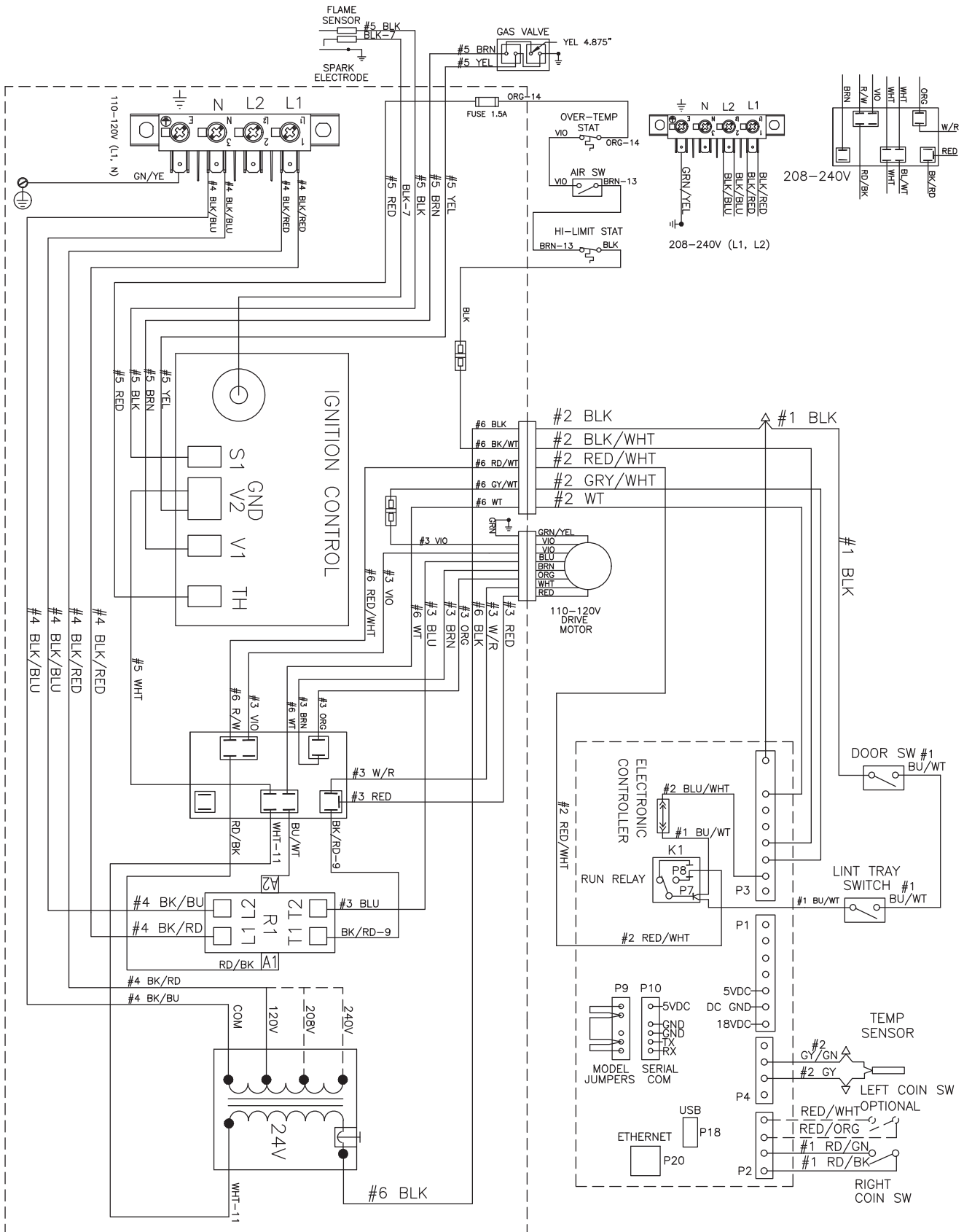

9506-808-001PR WIRING DIAGRAM DCS020N_-15_C_X-____-__X

Wiring Schematic 60 Hz

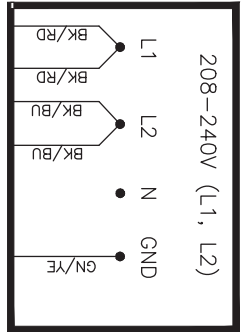

EXTERNAL GROUND MUST BE A NATIONAL/LOCAL ELECTRICAL CODE APPROVED GROUND AND CONNECTED TO THE DRYER GROUNDING TERMINAL.

110-120V
1~
60HZ

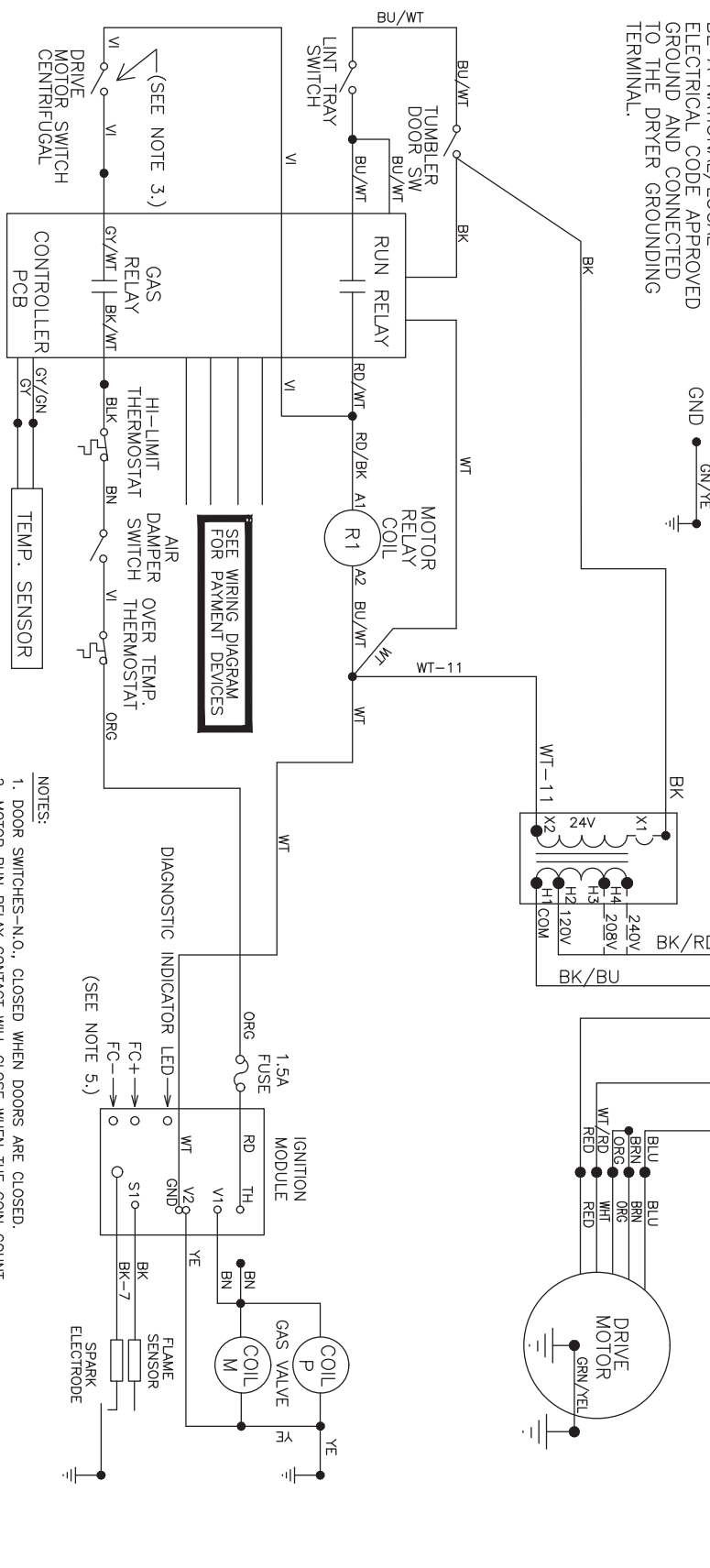
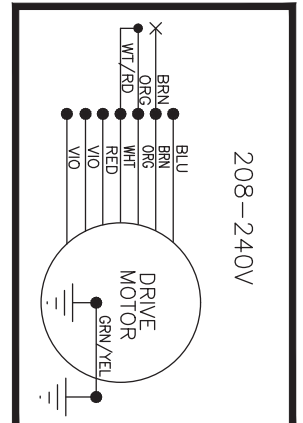
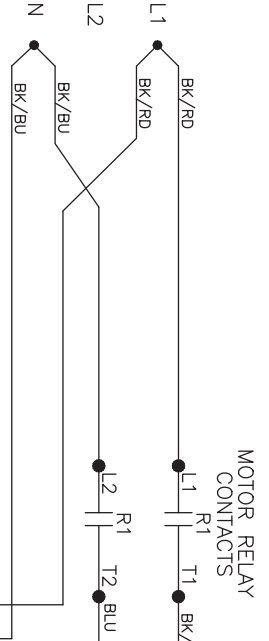

CAUTION: LABEL ALL WIRES PRIOR TO DISCONNECTION WHEN SERVICING CONTROLS. WIRING ERRORS CAN CAUSE IMPROPER AND DANGEROUS OPERATION. VERIFY PROPER OPERATION AFTER SERVICING. ATTENTION. AU MOMENT DE L'ENTRIEN DES COMMANDES, ÉTIQUETEZ TOUTS LES FILS AVANT DE LES DÉBRANCHER. DES ERREURS DE CÂBLAGE PEUVENT ENTRAINER UN FONCTIONNEMENT INADÉQUAT ET DANGEREUX. S'ASSURER QUE L'APPAREIL FONCTIONNE ADÉQUATEMENT UNE FOIS L'ENTRIEN TERMINÉ.

- NOTES:
1. DOOR SWITCHES-N.O., CLOSED WHEN DOORS ARE CLOSED.
 2. MOTOR RUN RELAY CONTACT WILL CLOSE WHEN THE COIN COUNT IS SATISFIED, THE DOOR CLOSED AND THE START BUTTON PRESSED
 3. CENTRIFUGAL SWITCH-N.O., CLOSES WHEN MOTOR IS UP TO SPEED.
 4. REFER TO OWNER'S MANUAL FOR DESCRIPTION OF OPERATION AND REQUIREMENTS FOR HEATING CIRCUIT.
 5. WITH A DC MICROAMMETER, FLAME CURRENT CAN BE MEASURED AT TEST POINTS. READING SHOULD BE 0.7UA DC OR HIGHER.

9506-808-001PR

SCHEMATIC

DCS020N_15_C_X_-----X

Coin Handling Group

Key	Description	Part Number	Qty
	Coin Acceptor, Optical, SWD, US Quarter	9021-094-001	1
*	Harness-Extention ,Control to Acceptor, Optical Dryer	9627-916-003	1
*	Retainer, Coin Acceptor	9486-145-001	1
*	Screw, Torx	9545-053-002	4
1	Switch Assembly, Optical Sensor, SWD	9801-099-003	1
*	Screw-Height Bar, 3mm	9545-039-002	2
	Below not included		
*	Harness, Acceptor Mechanical (Control to Acceptor)	9627-783-003	1
*	Coin Vault	9942-028-005	1
*	Screw, 10AB X 3/8	9545-008-024	2
*	Bracket-mounting,coinvault	9029-293-001	1

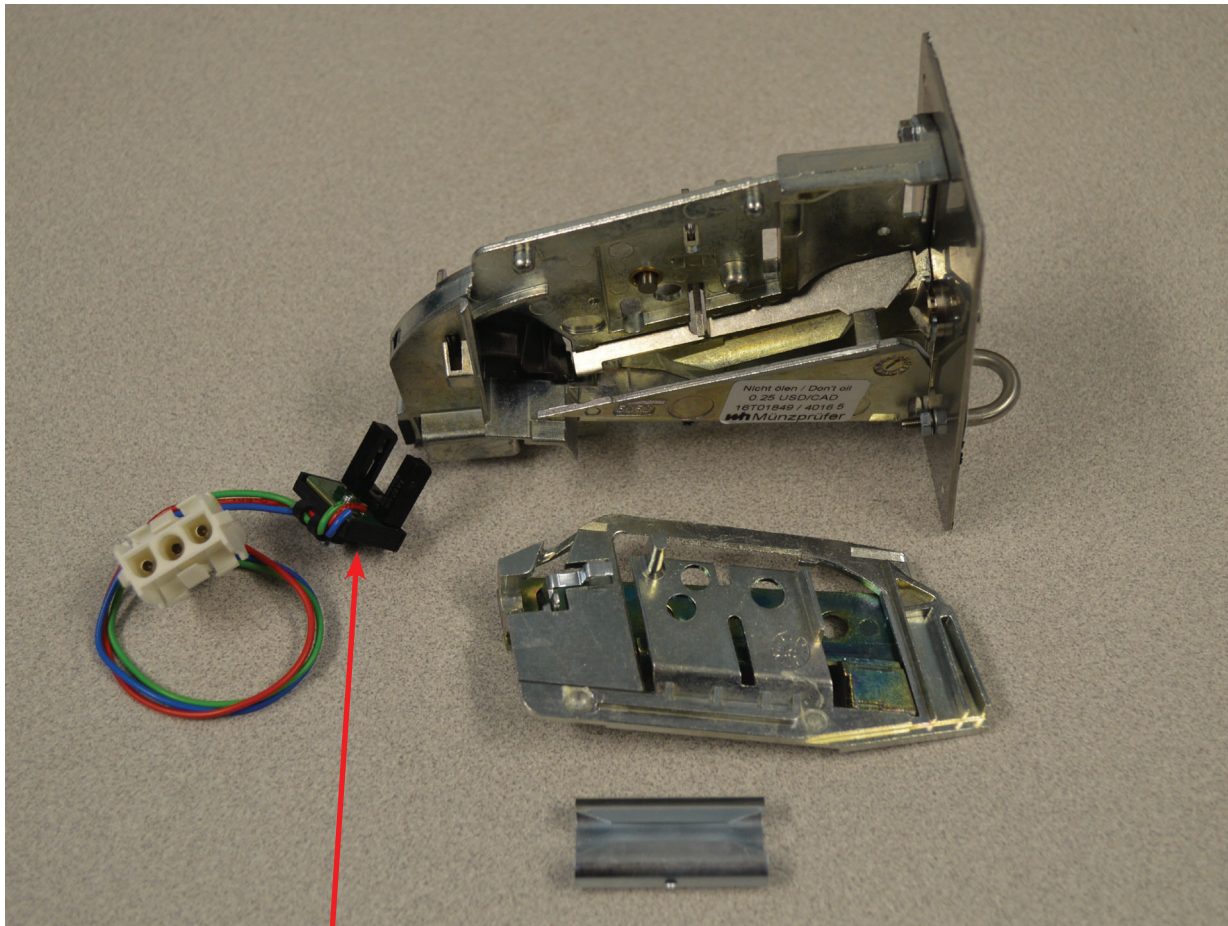

1

Coin Handling Group Electronic

Key	Description	Part Number	Qty
	Kit, Electronic Coin Acceptor	9732-303-004	1
	Acceptor-Electronic, US/CA	9021-054-001	1
	Harness, Control to Acceptor, Dryer	9627-909-003	1
	Harness, Control to Acceptor, Washer	9627-909-002	1
	Label-Wiring, Electronic Acceptor	8502-730-001	1
	Retainer Coin Acceptor, Electronic	9486-155-001	2
	Screw, 4B x 5/8 ss, Torx T-10	9545-053-002	4
	Below not included		
	Harness, Adaptor Electronic to Mechanical switch	9627-901-001	

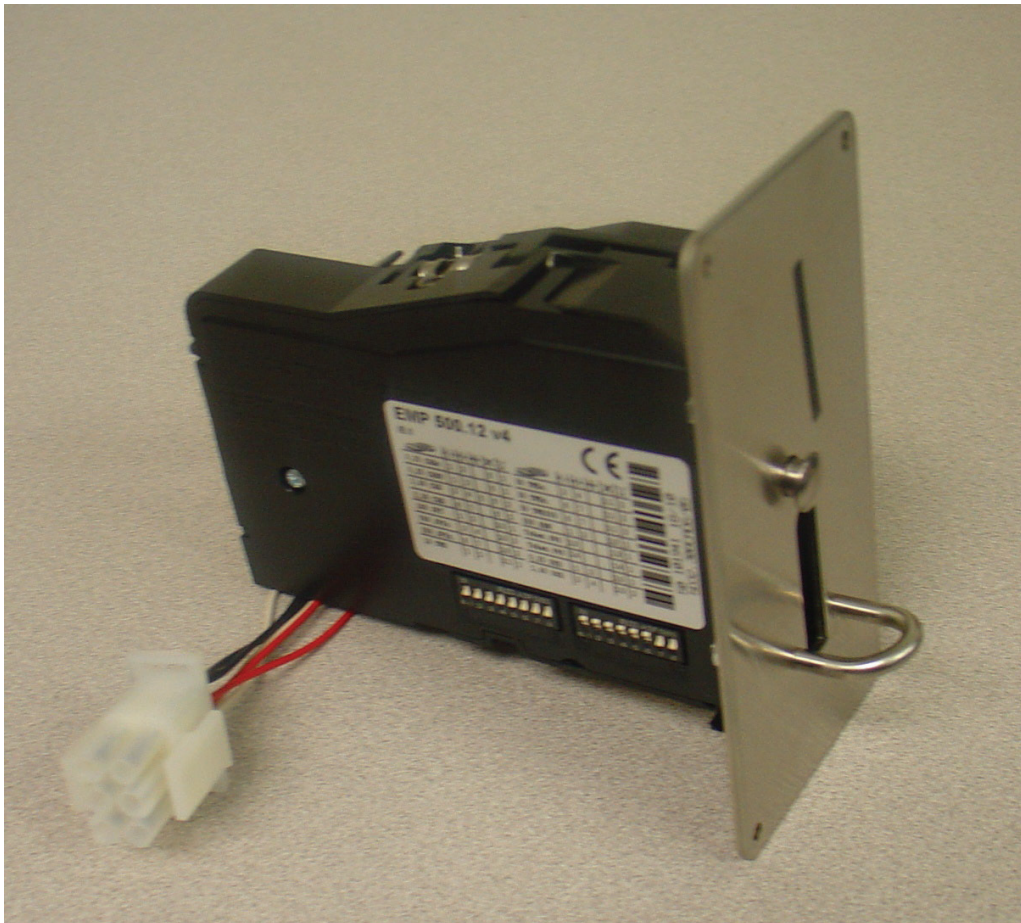

Section 6:

50 Hz Gas Dryer

Dryer Models

Parts in this section used only in these models. All other parts are same as standard 60 Hz pages.

-39 T-20 SWD 50 Hz Parts

Key	Description	Part Number	Qty
*	Strip, Terminal Marker -39 Models	9558-029-004	1
1	Transformer	8711-007-002	1
*	Instructions, Transformer Connect	8507-230-003	1
2	Ignition Control -39 Models	9857-182-001	1
*	Harness-Ignition Control,	9627-867-011	1
3	Wire Assembly High Voltage	9631-403-009	1
4	Motor	9376-332-001	1
5	Pulley, Motor Drive	9453-185-002	1
6	Harness Motor Extension	9627-864-007	1
*	Wiring Label Schematic/Diagram -39 models	9506-819-001	1
*	Owner's Manual	8514-280-001	1
*	Lint Drawer Assembly -39 Models	9866-008-002	1

Rear View Photos

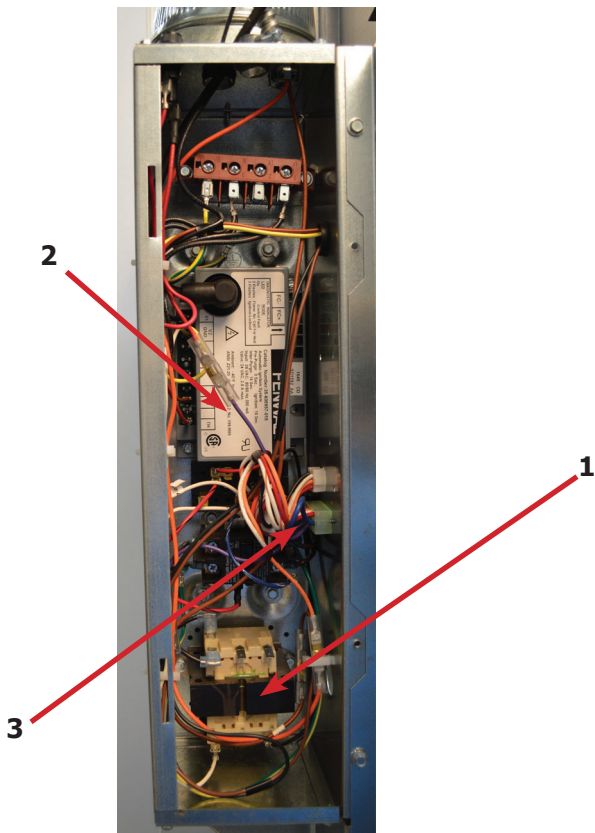
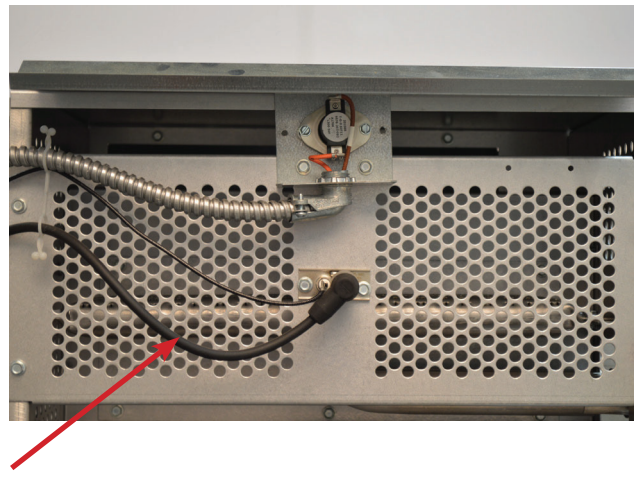
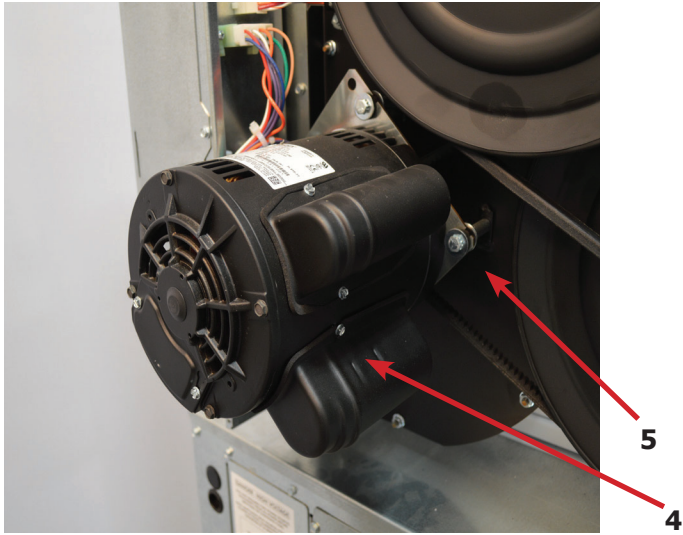

T-20 SWD -39 Gas Control Parts

Key	Description	Part Number	Qty
1	Kit-Honeywell VR86 Valve Flange	9732-162-001	1
*	Orifice, Main Burner #43	9425-069-025	2
2	Gas Control Valve	9857-132-004	1

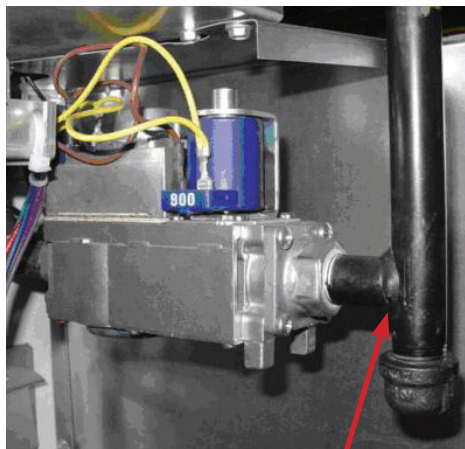

2

1

Coin Handling Group Electronic

Key	Description	Part Number	Qty
	Kit, Electronic Coin Acceptor	9732-303-004	1
	Acceptor-Electronic,	9021-054-001	1
	Harness, Control to Acceptor, Dryer (w/o lint door switch)	9627-909-003	1
	Harness, Control to Acceptor, Dryer (with lint door switch)	9627-909-005	1
	Harness, Control to Acceptor, Washer	9627-909-002	1
	Label-Wiring, Electronic Acceptor	8502-730-001	1
	Retainer Coin Acceptor, Electronic	9486-155-001	2
	Screw, 4B x 5/8 ss, Torx T-10	9545-053-002	4
	Below not included		
	Harness, Adaptor Electronic to Mechanical switch	9627-901-001	1

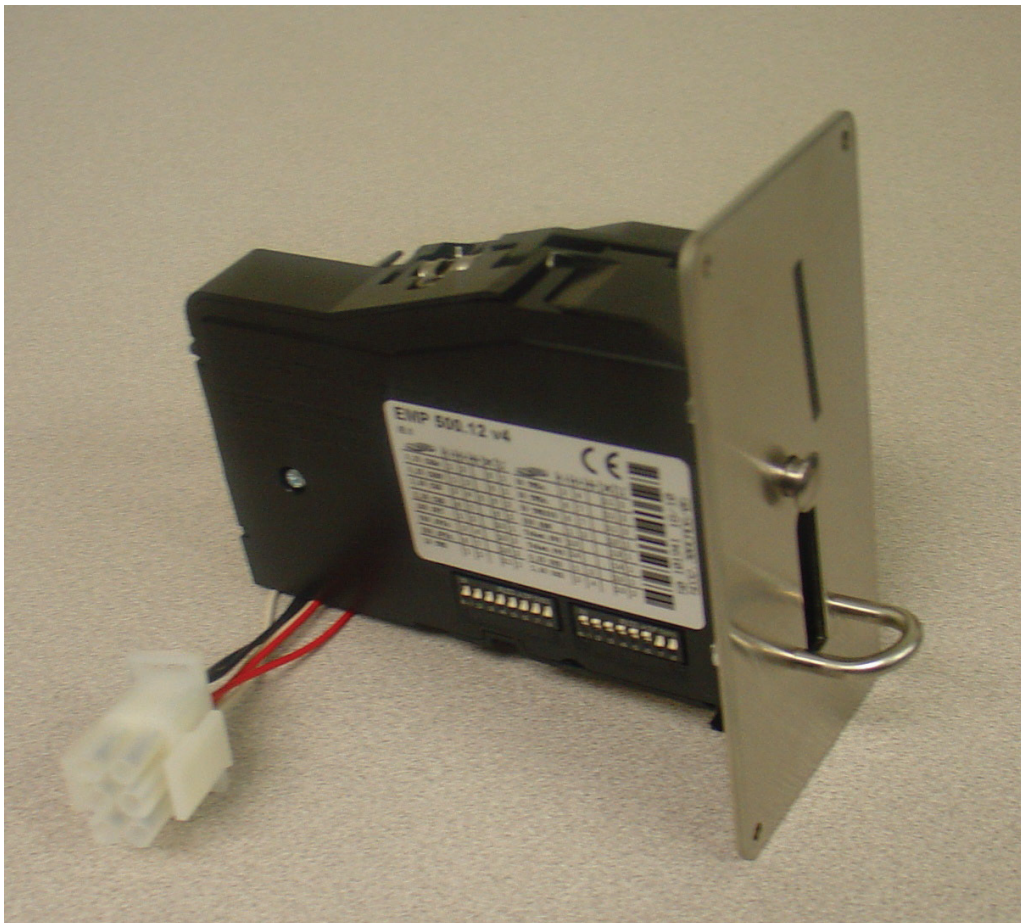

Notes

Ruled area for notes consisting of 26 horizontal lines.

Wiring Schematic for Dryer 50hz 230V -21CR

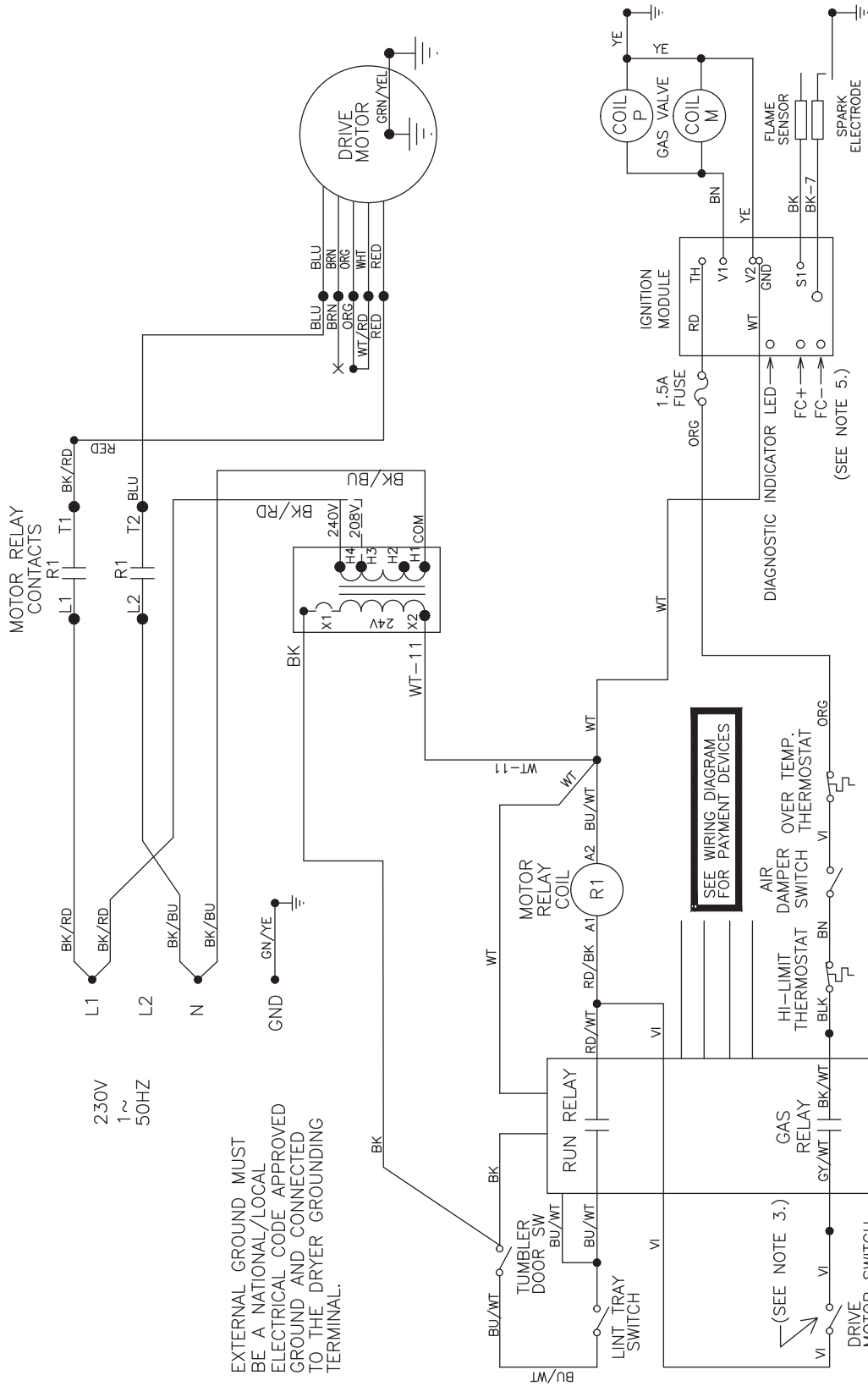

DCS020N_—39_C_X—_—_X

SCHEMATIC

9506—819—001PR

Wiring Diagram for Dryer 50hz 230V -39CR

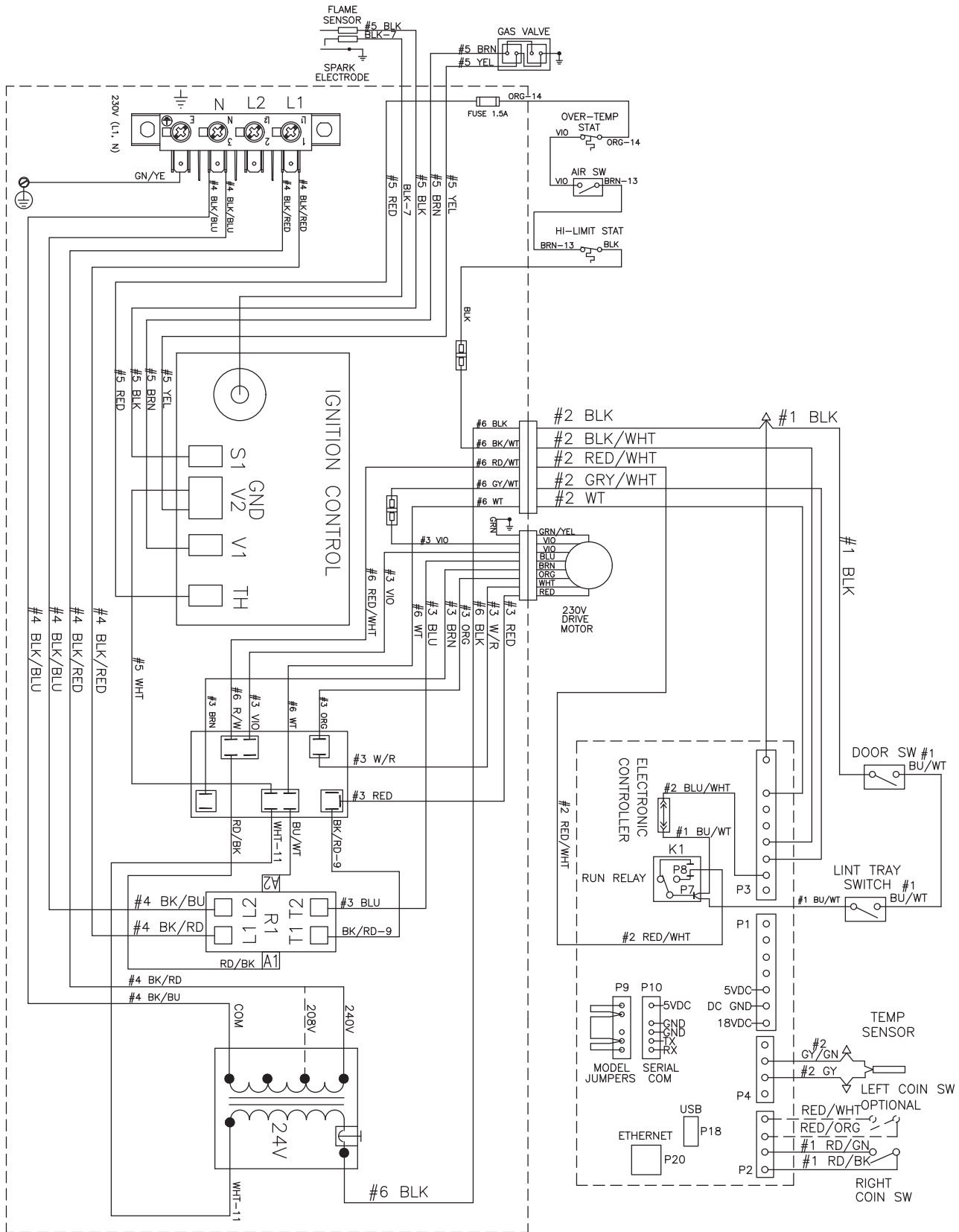

9506-819-001PR WIRING DIAGRAM DCS020N_-39_C_X-____-__X