

COMMERCIAL DRYER  
MODEL T-30X2 VENDED  
C-SERIES CONTROL, ELECTRICALLY HEATED

Original Instructions  
For GB & IE



**DEXTER**  
LAUNDRY

OPERATOR'S MANUAL  
INSTALLATION & OPERATION INSTRUCTIONS

The dryer will operate correctly in ambient temperatures of 5°C to 45°C, in relative humidity up to 50% at 40°C and above 50% when below 40°C, and at altitudes up to 1000m above sea level, must be transported and stored from -40°C to 140°C, and has been packaged to prevent damage from humidity, vibration, and shock. Take measures to avoid harmful effects of occasional condensation.

Post the following "**For Your Safety**" cautions in a prominent location:

**FOR YOUR SAFETY**

Do not store or use petrol or other flammable vapours and liquids or dry cleaning solvents in the vicinity of this or any other appliance.

**FOR YOUR SAFETY**

**THIS MACHINE IS FOR DRYING ONLY FABRICS WASHED IN WATER.** To avoid possibility of fire, including spontaneous combustion, do not dry oiled floor mops, items containing foam rubber or similarly textured rubberlike materials or any material on which you have used a cleaning solvent or which contains flammable liquids or solids (such as petrol, kerosene, waxes, etc.) Fabric softeners, or similar products, should be used per the fabric softener instructions. Remove all objects from pockets such as lighters and matches.

 **WARNING – Risk of Fire**

Clothes dryer installation must be performed by a qualified installer.

Install the clothes dryer according to the manufacturer's instructions and local codes.

Do not install a clothes dryer with flexible plastic venting materials. If flexible metal (foil type) duct is installed, use duct that has been investigated and found acceptable for use with clothes dryers. Flexible venting materials are known to collapse, be easily crushed, and trap lint. These conditions will obstruct clothes dryer airflow and increase the risk of fire.

To reduce the risk of severe injury or death, follow all installation instructions.

This appliance can be used by children aged from 8 years and above and persons with reduced physical, sensory or mental capabilities, or lack of experience and knowledge, if they have been given supervision or instruction concerning use of the appliance in a safe way and understand the hazards involved. Children shall not play with the appliance. Cleaning and user maintenance shall not be made by children without supervision. Children of less than 3 years should be kept away unless continuously supervised.













It is important that you read this Manual and retain it for future reference. For service or replacement parts, contact the distributor in your area or the manufacturer:

**Dexter Laundry, Inc.**  
2211 West Grimes Avenue  
Fairfield, Iowa 52556, USA

## TABLE OF CONTENTS

DRYER DIMENSIONS (Figure 1).....	5
UNCRATING.....	6
DRYER INSTALLATION (Figure 2).....	7
DRYER EXHAUST SYSTEM (Figure 3).....	10
DRYER SHUTDOWN.....	10
DESCRIPTION OF DRYER CONTROL.....	11
OPERATING INSTRUCTIONS.....	12
PROGRAMMING THE DRYER CONTROL.....	12
SERVICING AND TROUBLESHOOTING.....	25
PREVENTATIVE MAINTENANCE.....	26

### WARNINGS ABOUT USE AND OPERATION

 <p>Caution! There are sharp edges on various sheet metal parts internal to the enclosure. Use safety consciousness when placing or moving your hands while working in the interior of this equipment.</p>	
 <p>Meaning: Do Not Enter This Equipment (or Space).</p>	 <p>Meaning: Do Not Step, Stand, or Sit on This Equipment.</p>
 <p>Meaning: Do Not Operate with Guards or Covers Removed.</p>	 <p>Meaning: High Voltage. Disconnect power before servicing.</p>
 <p>Meaning: Lock Out and Tag Out before servicing.</p>	 <p>Meaning: Burn Hazard. Do Not Touch Heater Housing or Heating Elements. Allow these parts to cool before servicing.</p>
 <p>Meaning: Do Not Dry Items Containing Explosive Material.</p>	 <p>Meaning: Do Not Dry Items Containing Flammable Material.</p>
 <p>Meaning: Read Operators Manual.</p>	 <p>Meaning: Center of Gravity.</p>
 <p>Meaning: Left Point for Forklift or Hand Pallet Truck or Jack.</p>	 <p>Meaning: Right Point for Forklift or Hand Pallet Truck or Jack.</p>

**DO NOT MODIFY THIS APPLIANCE. KEEP SHIELDS, GUARDS, AND COVERS IN PLACE.** These safety devices are provided to protect everyone from injury.

It is **ABSOLUTELY ESSENTIAL** that the dryer be connected to a good earth connection. This is not only for personal safety, but is necessary for proper operation of the controller. Failure to do so will void the warranty of the controller.

**THIS DRYER IS EQUIPPED WITH A MANUALLY RESETTABLE OVER-TEMPERATURE THERMOSTAT** located on the side of the exhaust duct above each motor. If the dryer ceases to operate, reset the thermostat by rotating the lever bracket clockwise. If the thermostat continues to trip, the dryer must be inspected by a qualified service person.





**CHECK THIS THERMOSTAT WHEN INSTALLING DRYER** to assure it is not tripped. Impacts, such as rough handling in shipment, may trip the thermostat.

## **WARNINGS ABOUT USE AND OPERATION** continued

**WARNING:** Do not stop dryer before end of cycle time unless all items are quickly removed and spread out to dissipate heat.

**DO NOT SPRAY AEROSOLS IN THE VICINITY OF THIS APPLIANCE** while in operation.

**THIS APPLIANCE SHALL NOT BE USED TO DRY OFF CLOTHES CONTAINING SOLVENTS OR DRY-CLEANING FLUIDS.**

Misuse of Dryer	
	Do not use this Equipment for any purpose not described in this Manual.
	Do not operate this equipment without all guards and covers in place.
	Do not operate this dryer from any power source not matching the operational requirements on the back of the dryer.
	Do not place your body inside the dryer cylinder or allow others to do so. Death or serious injury can result from this!
<b>Other Examples May Be Applicable</b>	



**Caution – Replace Fuses With Same Type and Rating**

Fuse No.	Voltage	Amperage	SC I/R	Type	Size
F1	250V	2.5A	100A@250VAC	F	¼ x 1¼ in. (6.35 x 31.75 mm)

## SPECIFICATIONS

### **13.6 kg (30 lb.) Commercial Stack Dryer: T-30x2 - DC30X2E\_-79CC\_X**

Cabinet Height	76 1/4 in.	1937 mm.
(Assumes minimum leveling leg adjustment)		
Cabinet Width	31 1/2 in.	800 mm.
Overall Depth	49 3/4 in.	1264 mm.
Floor to Bottom of Door- Bottom Dryer	7 3/4 in.	197 mm.
Floor to Bottom of Door- Top Dryer	45 1/2 in.	1156 mm.
Door Opening	22 5/8 in.	575 mm.
Dry Wt. Capacity	30 x 2 lbs.	13.6 x 2 kg.
Cylinder Diameter	30 in.	762 mm.
Cylinder Depth	27 1/2 in.	699 mm.
Cylinder Volume	11.25 cu. ft.	319 liters
Lint Screen Area	453 sq. in.	2923 sq. cm.
Electric Heat Input (per dryer)	24 kW	
Exhaust Size	8 in.	203 mm.
Make-up Air	1.5 sq. ft.	1394 cm <sup>2</sup> .
Example: 1.5 sq. ft = 1 ft. long X 1.5 ft. wide		
Motor Size	1/2 H.P.	.373 kW
Airflow	500 CFM	14.2 m <sup>3</sup> /min

### **Electrical Specifications - 230/50/1**

Voltage/Hz/Phase	400V/50Hz/3Phase
Running Amps	45
Circuit Protection Amps	50
Wire Size	#6 gauge (13.3 mm <sup>2</sup> )
Electrical Service	L1 + L2 + L3 + N + PE

Shipping Weight	750 lbs.	340 kg.
Net Weight	699 lbs.	317 kg.
Clearance Behind Machines (min.)	18 in.	457 mm.

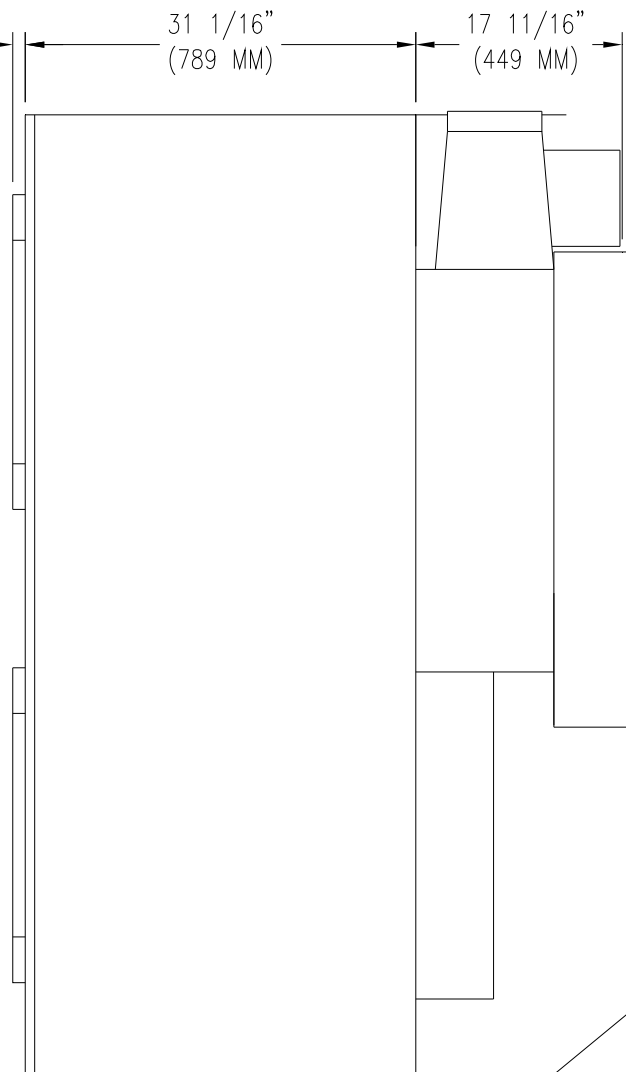
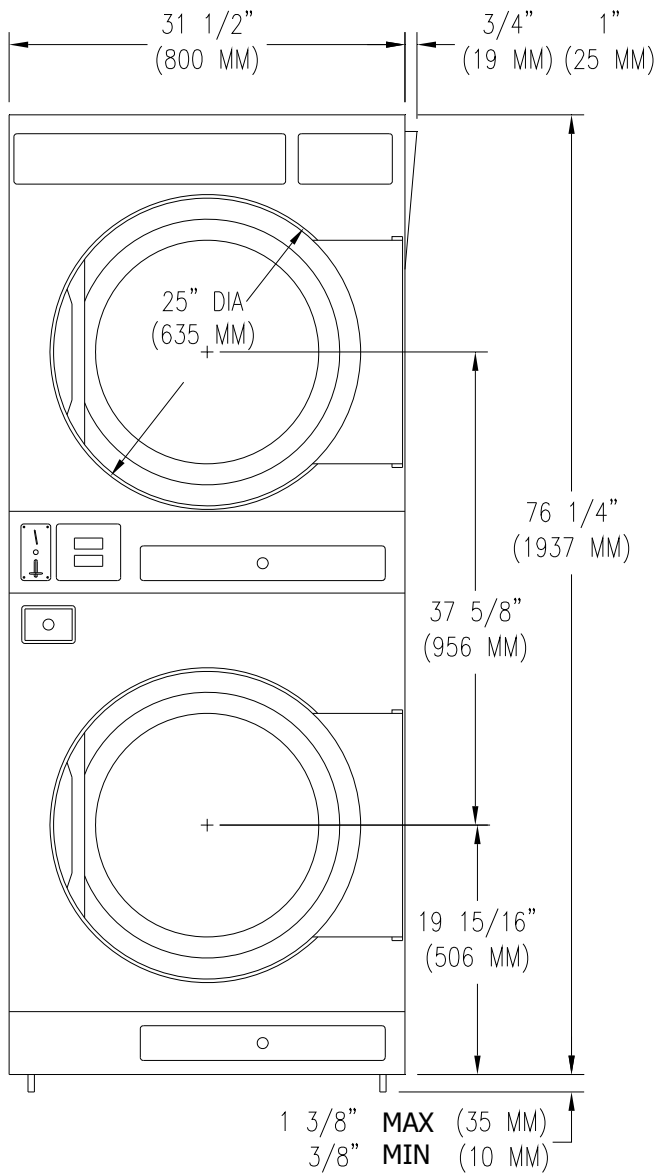
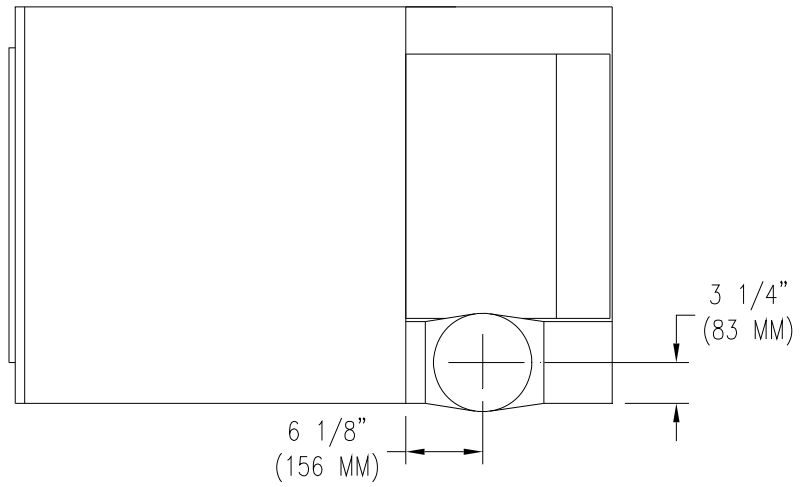

## INSTALLATION INSTRUCTIONS

**Note: A forklift, or a hand pallet truck or jack, must lift the dryer and only from the front or rear of the dryer with the dryer bolted to the pallet and supported the full length of the dryer.**

### **UNCRATING AND PLACING DRYER**

Tools Required: 19 mm (3/4 in.) hex socket & ratchet driver, wood block 100 mm (4 in.) or 125 mm (5 in.) thick, a knife, and groove joint pliers, which will open to 35 mm (1 3/8 in.).

1. Remove and discard the packaging.
2. The crate base is attached to the dryer by (4) cap screws driven upward from below the crate base. Remove the crate base from the dryer, by tipping the dryer sidewise and place the block under the crate base rail in the center of the dryer. Using the ratchet and the 19 mm (3/4 in.) hex socket, remove the (2) crating bolts from the side, which is raised, and save for future moving of the dryer. Remove the block from under the crate base. Repeat for the other side.
3. With a walking motion, move the dryer completely off the crate base. Save the crate base for future moving of the dryer.
4. Slide the unit into the position where it will be installed. Adjust the leveling legs, using the groove joint pliers, to level and align the dryer with adjacent units.

Note: If the dryer is ever moved again, the dryer should be re-mounted on its crate base and its crating bolts re-inserted and tightened, in the reverse order as above.

Dryer Model	Mass
DC30X2E_-79	340 kg

### **DRYER INSTALLATION**

1. **CODE CONFORMITY:** All commercial dryer installations must conform to the local and the national codes for the location of the installation.

The appliance must not be installed behind a lockable door, a sliding door or a door with a hinge on the opposite side to that of the tumble dryer, in such a way that a full opening of the tumble dryer door is restricted.

2. **INSTALLATION CLEARANCES:** This unit may be installed at the following alcove clearances.

- I. Left Side      0 in.
- II. Right Side    0 in.
- III. Back          457 mm (18 in.) (Certified for 150 mm (6 in.) clearance; however, 457 mm (18 in.) clearance is necessary behind the belt guards to allow for servicing and maintenance.)
- IV. Front          1220 mm (48 in.) (To allow use of dryer.)
- V. Top             Refer to Figure 2 labeled "Vertical Clearance Dimensions".  
AB. Certification allows 0 in. clearance at the top, 100 mm (4 in.) back from the front. However, a 6 mm (1/4 in.) clearance should be allowed in case the dryer needs moving.  
C. A 254 mm (10 in.) clearance is required from top at all other points.
- VI. Floor          This unit may be installed upon a combustible floor.

Do not obstruct the flow of combustion and ventilation air.

Maintain minimum of 25 mm (1 in.) clearance between duct and combustible material.

Refer to the installation label attached to the Belt Guard on the rear of the dryer for other installation information and start-up instructions.

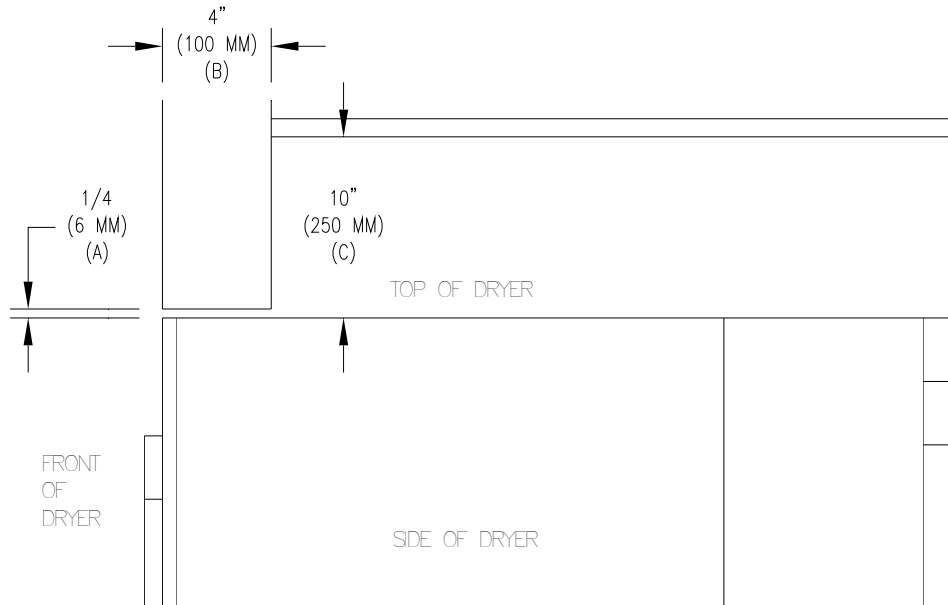

FIGURE 2— Vertical Clearance Dimensions

**3. MAKE-UP AIR.** Adequate make-up air (17 m<sup>3</sup>/min./DRUM (600 CFM), 34 m<sup>3</sup>/min./DRYER (1200 CFM)) must be supplied to replace air exhausted by dryers on all types of installations. Provide a minimum of 0.14 m<sup>2</sup> (1.5 ft.<sup>2</sup>) make-up air opening to the outside for each dryer. This is a net requirement of effective area. Screens, grills or louvers, which will restrict the flow of air, must be considered. Consult the supplier to determine the free area equivalent for the grill being used.

The source of make-up air should be located sufficiently away from the dryers to allow an even airflow to the air intakes of all dryers. Multiple openings should be provided.

The operation of this appliance may affect the operation of gas appliances, which take their air for safe combustion from the same room. Adequate ventilation must be provided to avoid back flow of gasses from other appliances in the same room. All gas appliances should be tested with the Dexter dryer in operation and all the windows and doors closed. If in doubt, consult the appliance manufacturer(s).

#### 4. ELECTRICAL REQUIREMENTS.

The electrical installation must be performed by a qualified electrical technician.

The electrical power requirements necessary to operate the unit satisfactorily are listed on the serial plate located on the back panel of each dryer. The electrical connection should be made at the terminal blocks in the two control boxes on the rear of the unit using conductors rated at 75°C (167°F) and a wire size adequate to handle the amperage and voltage listed on the serial plate (see the table on the next page for recommended minimum sizes). It is absolutely necessary that the dryer be connected to a known earth (No. 8 AWG copper conductor recommended). Knockouts are provided for the connection of 1-inch (25 mm) conduit for the power supply conductors and 3/8-inch (10 mm) conduit for the external earthing conductor. It is absolutely necessary that the dryer be connected to a known earth connection. The earth connection resistance should be checked prior to operation. Introduction of supply wiring must not increase the Ingress Protection (IP) rating.

HEATING ELEMENT SIZE (kW)	SUPPLY VOLTAGE (PHASE / V.)	MINIMUM DUAL ELEMENT TIME DELAY FUSE SIZE AT FUSED DISCONNECT (A.)	MINIMUM WIRE SIZE FROM FUSED DISCONNECT TO DRYER TERMINAL BLOCK (75°C COPPER WIRE)
24	3 / 400	50	# 6 (13.3 mm <sup>2</sup> )

The installation must meet the electrical requirements of the country, state, and locality of the installation. Individual circuit breakers for each dryer are required. The installer must provide a disconnect switch which will interrupt all lines. It may be a local or national requirement to provide an electrical interruption switch visible and accessible from the room in which the dryer is installed. The wiring diagram is located in the control box on the back of the dryer.

For destination countries where CE requirements must be met, individual 400V supply disconnecting devices for each dryer are required and must be one of the following types:

- switch-disconnector with fuses per IEC 60947-3 utilization category AC-23B;
- disconnecter with fuses per IEC 60947-3 having an auxiliary contact that in all cases causes switching devices to break the load circuit before the opening of the main contacts of the disconnecter;
- a circuit-breaker suitable for isolation per IEC 60947-2;
- any other switching device in accordance with an IEC product standard for that device and which meets the isolation requirements of IEC 60947-1 as well as a utilization category defined in the product standard as appropriate for on-load switching of motors or other inductive loads;

The supply disconnecting devices must

- provide a means allowing the supply disconnecting devices to be locked in the OFF position;
- be mounted 0.7 m to 1.7 m above the floor, within 2 m from the dryer, and within 8 m from the operator position;
- have a red actuator to indicate that it serves a dual Emergency Stop function;
- be rated for branch circuit operation;
- be approved for use in the country where installed;

**CONTROL TRANSFORMER CONNECTIONS** Adjustment for different voltages of supply mains.

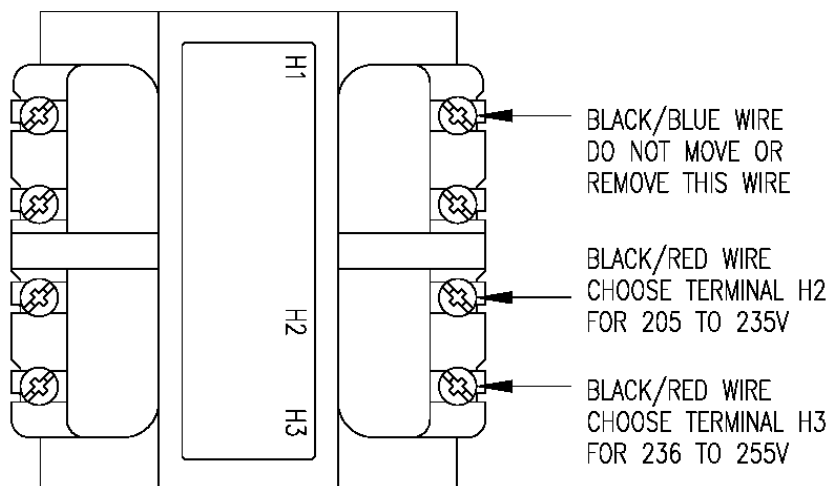

**IMPORTANT: TRANSIENT VOLTAGE SURGE SUPPRESSORS**

Like most electrical equipment your new machine can be damaged or have its life shortened by voltage surges due to lightning strikes which are not covered by factory warranty. Local power distribution problems also can be detrimental to the life of electrical components. We recommend the installation of transient voltage surge suppressors for your new equipment.



These devices may be placed at the power supply panel for the complete installation and don't require an individual device for each machine.

These surge protectors help to protect equipment from large spikes and also from small ongoing spikes in the power that occur on a day to day basis. These smaller surges can shorten overall life of electrical components of all types and cause their failure at a later date.

Although they can't protect against all events, these protective devices have a good reputation for significantly lengthening the useful life of electronic components. Electronic components are helped to have a longer useful life when they are supplied with the clean stable electrical power they like.

6. EXHAUST INSTALLATION. (Refer to Figure 3) Exhausting of the dryer(s) should be planned and constructed so that no air restrictions occur. Any restriction due to pipe size or type of installation can cause slow drying time, excessive heat, and lint in the room.

From an operational standpoint, incorrect or inadequate exhausting can cause a cycling of the high limit thermostat, which shuts off the heating elements and results in inefficient drying.

The exhaust duct connection near the top of the dryer will accept a 203 mm (8 in.) round duct. Individual exhausting of the dryers is recommended. All heat, moisture, and lint should be exhausted outside by attaching a pipe of the proper diameter to the dryer adapter collar and extending it out through an outside wall. This pipe must be very smooth on the inside, as rough surfaces tend to collect lint, which will eventually clog the duct and prevent the dryer from exhausting properly. All elbows must be smooth on the inside. All joints must be made so the exhaust end of one pipe is inside the next one downstream. The addition of an exhaust pipe tends to reduce the amount of air the blower can exhaust. This does not affect the dryer operation if held within practical limits. For the most efficient operation, it is recommended that no more than 4.27 m (14 ft.) of straight 203 mm (8 in.) diameter pipe with two right angle elbows be used for each cylinder. The design of the vent system shall be such that any condensate formed when operating the dryer from cold shall either be retained and re-evaporated or discharged.

Maintain a minimum of 25 mm (1 in.) clearance between duct and combustible material.

If the exhaust pipe passes through a wall, a metal sleeve of slightly larger diameter should be set in the wall and the exhaust pipe passed through this sleeve. This practice is required by some local codes and is recommended in all cases to protect the wall. This type of installation should have a means provided to prevent rain and high winds from entering the exhaust when the dryer is not in use. A hood with a hinged damper can be used for this purpose. Another method would be to point the outlet end of the pipe downward to prevent entrance of wind and rain. In either case, the outlet should be kept clear, by at least 610 mm (24 in.), of any objects, which would cause air restriction.

Never install a protective screen over the exhaust outlet.

When exhausting a dryer straight up through a roof, the overall length of the duct has the same limits as exhausting through a wall. A rain cap must be placed on top of the exhaust and must be of such a type as to be free from clogging. The type using a cone shaped "roof" over the pipe is suitable for this application.

Exhausting the dryer into a chimney or under a building is not permitted. The exhaust air should not be vented into a wall, a ceiling, or a concealed space of building. In these cases, there is a danger of lint buildup, which can be highly combustible.

Installation of several dryers, where a main discharge duct is necessary, will need the following considerations for installation (see Figure 3). Individual 203 mm (8 in.) exhaust ducts from each dryer should enter the main discharge duct at a 45-degree angle in the direction of discharge airflow.

NOTE: Never install the individual 203 mm (8 in.) ducts at a right angle into the main discharge duct. The individual ducts from the dryers can enter at the sides or bottom of the main discharge duct. Figure 3 indicates the various round main duct diameters to use with the individual dryer ducts. The main duct can be rectangular or round, provided adequate airflow is maintained. For each individual dryer, the total exhausting (main discharge duct plus duct outlet from the dryer) should not exceed the equivalent of 4.27 m (14 ft.) and two elbows. The diameter of the main discharge duct at the last dryer must be maintained to exhaust end.

NOTE: A small diameter duct will restrict airflow; a large diameter duct will reduce air velocity - both contributing to lint buildup. An inspection door should be provided for periodic clean out of the main duct.

NOTE: Exhaust air must not be discharged into a flue which is used for exhausting fumes from appliances burning gas or other fuels.

**Caution** - A clothes dryer produces combustible lint and should be exhausted outdoors. The area around the clothes dryer should be kept free of lint.

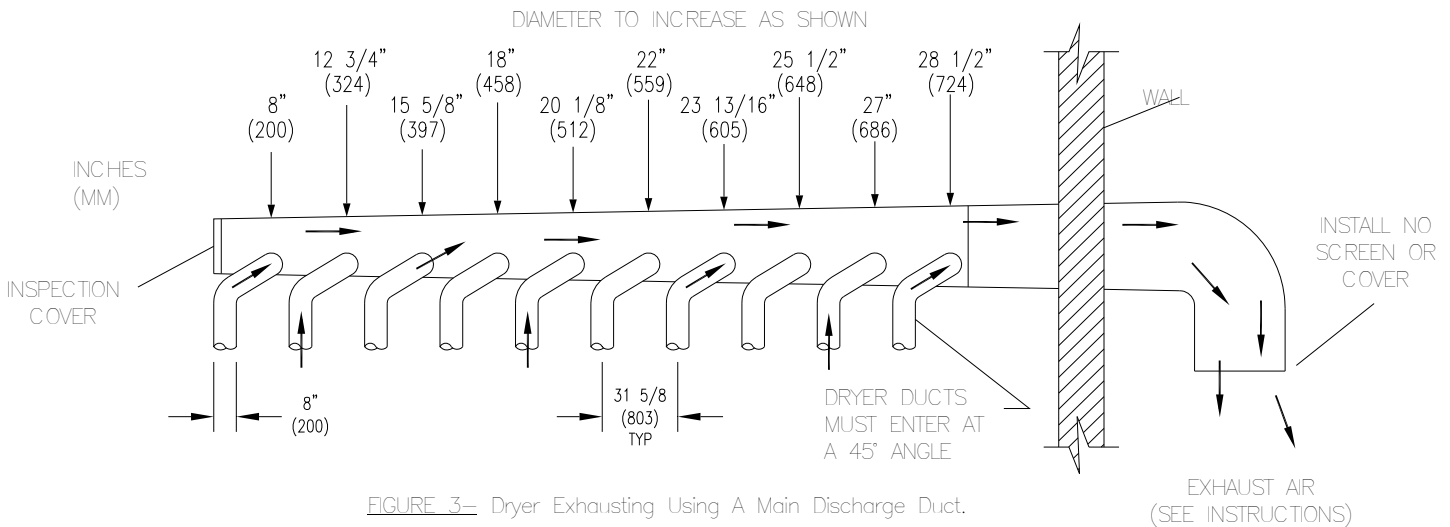

FIGURE 3— Dryer Exhausting Using A Main Discharge Duct.

NOTE: The A-weighted emission sound pressure level does not exceed 70dB(A). The operator does not need hearing protection.

NOTE: The dryer does not emit hazardous radiation.



**WARNING:** To avoid potential risks of spontaneous combustion of a load, remove the load quickly after the completion of the cycle or in case of failure of power supply.



**DANGER:** Do not dry loads which may create an explosive atmosphere in the dryer.

### **DRYER SHUTDOWN**

To render the dryer inoperative, disconnect electrical supply to the dryer.

## DESCRIPTION OF DRYER CONTROL

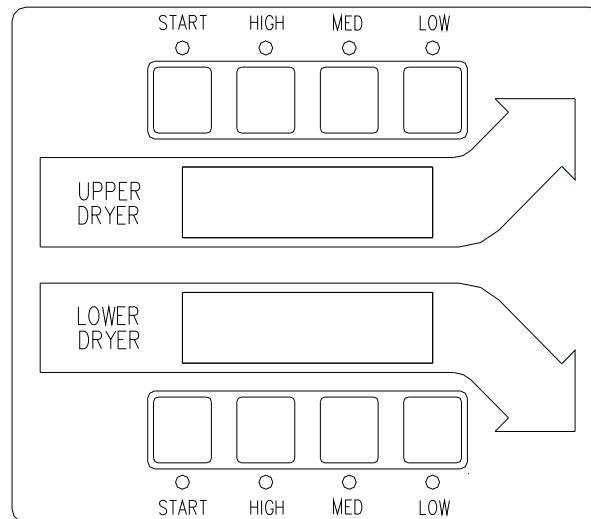

Both dryers are operated by the controller at the left midpoint of the dryer. The controller is two-in-one with the upper display and lights dedicated to the upper dryer and lower display and lights dedicated to the lower dryer.

1. When money has been deposited, the control will prompt the user to choose a drying temperature and press the "start" button. Time is not added until this occurs for either the upper or lower dryer. If no purchased time is available on the control, the vend price is displayed.

The drying program (temperature) selected by the user is indicated by the red lights at the top and bottom. When the dryer is in use, the drying temperature may be displayed by simultaneously pressing the "start" button and the button of the temperature selected.

Cool-down time (owner programmable) is always part of the cycle time to prevent damage from heat and is purchased by the customer. For example, if cool-down time is 2 minutes, the last two minutes of the cycle will have no heat.

## **OPERATING INSTRUCTIONS**

### **STARTING THE DRYER**

1. Load clothes into either the upper or lower dryer (or both). Close the door(s) completely.
2. Deposit coins equal to or greater than the displayed vend price. The control will prompt the user to choose a drying temperature. Time is not added until this occurs for either the upper or lower dryer.
3. Select drying temperature by pressing the appropriate button for the dryer to be used. This will turn on the red light showing the selected temperature.
4. Press "start" button to start dryer. This will display the drying time purchased.

### **RUNNING THE DRYER**

-Opening the door will stop the dryer. The dryer will restart, if time has not expired, upon closing the door and pressing the "start" button.

-Selected temperature may be changed at any time (unless Temperature Pricing feature is activated).

-Running time may be extended by depositing coins and pressing the "start" button for the correct dryer. Unless time has expired, the controller will accept coins whether or not the original vend price is equaled.

If time has run out, the dryer must be restarted as if it was at the beginning of drying the load, which requires meeting or exceeding the vend price.

## **PROGRAMMING THE DRYER CONTROL**

The dryer control can be programmed to prompt the user for alternate vend prices, change dryer cycle times, temperatures and many other options. This can be accomplished in two ways:

1. Manual programming utilizing the "Start", "High", "Medium" and "Low" buttons for the bottom dryer.
2. USB download of a customizable User File. For instructions on using the USB download feature, please contact your local Dexter distributor or visit [DexterLive.com](http://DexterLive.com).

### **MANUAL PROGRAMMING:**



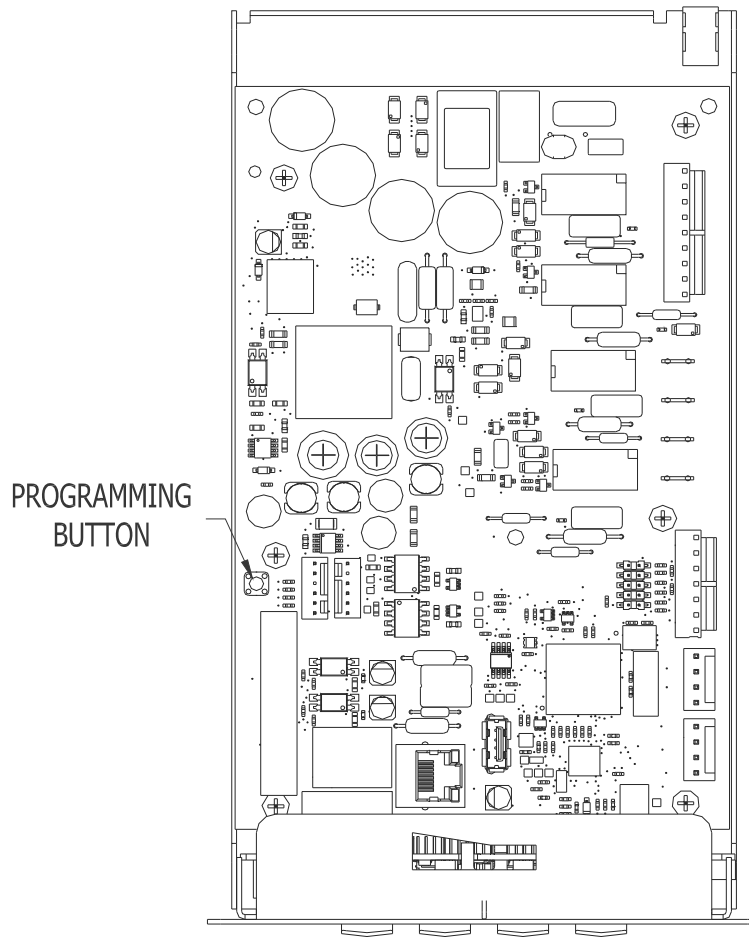

The dryer must be in idle mode for the manual programming menus to be accessed. Idle mode is when the dryer is not actively running a drying cycle and the vend price is displayed on the screen (for both upper and lower dryers).

To enter the manual programming mode, the control tray on the dryer must be unlocked and pulled out to reveal the programming button. The programming button is then pressed for 1 second. The control should display "DRYER PROGRAMMING".

See the figure below for the location of the programming button on the control tray.



When manual programming mode is entered, the "Start", "High", "Medium" and "Low" buttons for the lower dryer perform alternate functions. Please note that the changes made using the lower dryer buttons affect both upper and lower dryers.

Button Name	Alternate Function in Programming Mode
Start 	Becomes the action to accept the displayed option or the "Enter" key
High 	Becomes the action to move UP through displayed options (Press & hold for accelerated scrolling)
Medium 	Becomes the action to move DOWN through displayed options (Press & hold for accelerated scrolling)
Low 	Becomes the action to move back a step (1 press) or EXIT from programming mode (press for 3 seconds)

These alternate functions allow the user to move through a menu of options to choose various programmable settings. The figure below shows the top level menu. Choosing an option from the top level menu will then display the next level of options (the sub menu).

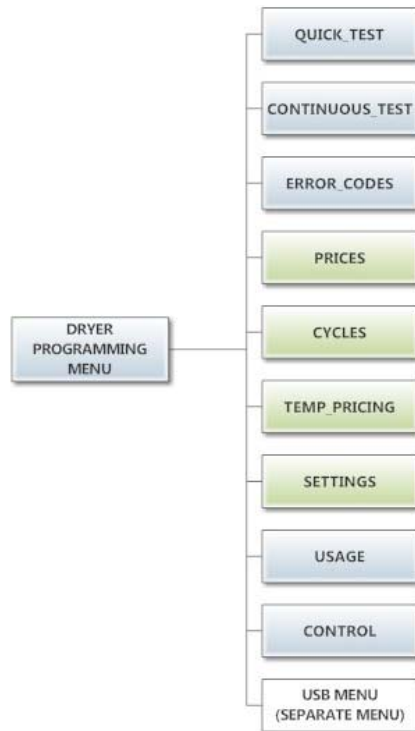

**Quick Test Option:**

When the Quick Test Option is chosen, the dryer will begin a shortened dry cycle without the displayed vend price being met. The purpose of this shortened cycle is to test all major components for proper operation.

Error Codes should all function normally during this test. The display will show customer prompts in a similar way to a normal dry cycle.

**Continuous Test Option:**

Similar to the Quick Test, when the Continuous Test Option is chosen, the dryer will begin a dry cycle without the displayed vend price being met. However, in this case, it will be a continuously-running cycle. It will not time out after any designated amount of time.

CAUTION: This option is meant for factory use only. Do not operate the dryer with this cycle active without factory authorization.

**Error Code Historical Log:**

The last fifteen occurring error codes will be stored in the control with a time and date stamp. The purpose of this option is only to observe the history of these code occurrences (no changes can be made).

The time is based off the Real Time Clock, but potentially shifted by the user’s manual programming changes (Shift Hours option) and/or network time override. As additional error codes occur, the oldest of the fifteen logged codes is cleared from memory.

### Prices Option:

This option allows the user to set values for coin acceptor inputs, vend price & time and extend dry price & time. It also allows the user to return the values to factory defaults. After changing prices using the "Up" or "Down" buttons, the "Enter" button must be pressed again for the control to store the changes that have been made. Note that, in general, time values are set in 1 minute increments. This can be changed to 30 second increments, by changing the "Display Time" to "MIN+SEC" (refer to the "Settings" section).

1. "RIGHT COIN" and "LEFT COIN" are the two possible inputs from coin acceptors.
2. "PRICE SET VEND" is the actual Base Vend Price (or Vend Price A) that is shown on the control display. The value can be increased or reduced even down to "0". In this case, the displays will prompt "FREE" and the cycle will start as soon as the "Start" button is pressed (without any vend price being met).
3. "TIME SET VEND" is the cycle time that the customer has available once they've met the Base Vend Price.
4. "FREE SET TIME" is the cycle time that the customer has available if the Base Vend Price is set to "FREE".
5. "EXTEND DRY" sets the price and time for additional drying time that becomes available after the customer has already met the Base Vend Price.

To reset either the coin acceptor inputs or the vend price to factory default, press "Enter" when the "DEFAULT" prompt is shown. Press "Enter" again when the "RESET" prompt is shown to confirm the action.

Example- A store owner has programmed the control for the following values:

Base Vend Price	\$1.00
Base Vend Time	30 minutes
Extend Dry Price	\$.25
Extend Dry Time	8 minutes

In this case, the customer adds 4 quarters to satisfy the \$1.00 Vend Price. The display shows 30 minutes of drying time. At this point, if an additional quarter is added, the customer display shows an additional 8 minutes of drying time (38 minutes total) as per the Extend Dry Price & Time.

The customer starts the drying cycle and at 25 minutes into the cycle (13 minutes displayed), they add an additional quarter. The controller adds 8 minutes to the displayed time again (21 minutes total) as per the Extend Dry Price & Time.

"AFTER CYCLE" allows the user to choose whether a customer is allowed to add "EXTEND DRY" time for up to 30 seconds after the dryer door is opened after a completed cycle.

The figure below shows the sub menu options for Prices:

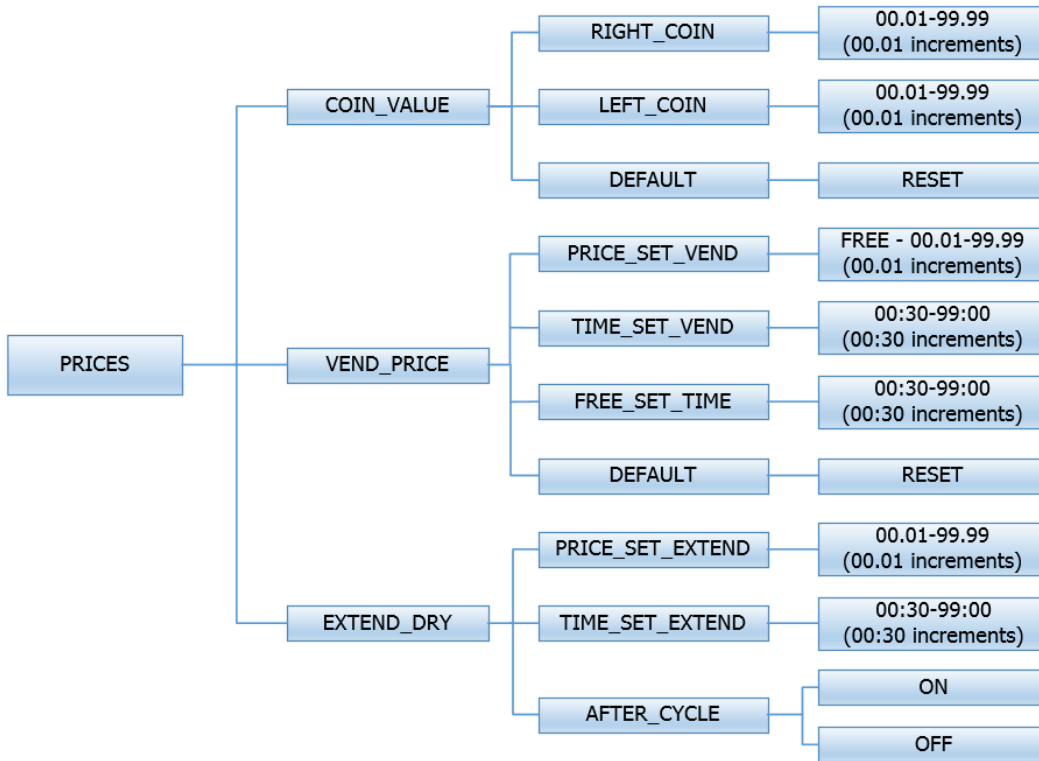



### Cycles Option:

This option allows the user to set temperature and cooldown information for the drying cycle. It also allows the user to return the values to factory defaults.

1. "TEMP SETTINGS" allows the user to make adjustments, within a designated range, to the cycling temperature for each of the "Low", "Medium" and "High" customer choices.
2. In addition, on the "Low" setting, the user can reduce the cycling temperature below 110 degrees F. In this case, when the customer chooses the "Low" setting, the dryer will not turn on the heat relay. When checked, the displayed temperature will read "NO HEAT".
3. "COOLDOWN" allows the user to change the designated time at the end of a cycle where the heat relay is turned off. On "High" and "Medium" temperature settings, the designated time cannot be reduced to less than 2 minutes.
4. "DEFAULT TEMP" allows the user to choose which general temperature setting, "High", "Medium" or "Low", the control will default to at the beginning of each cycle if the customer does not make a choice.
5. "ANTI WRINKLE" is a feature that periodically rotates the dryers after a cycle is complete. If the door was closed at the end of the cycle, and is left closed for 5 minutes, the enunciator will sound and the display begins scrolling "ANTI WRINKLE". 5 seconds later, the dryer motor will turn on for 60 seconds and then turn off. The heat relay will not be turned on. The "ANTI WRINKLE" message will continue throughout the time that the motor is turned on. The user can choose to enable or disable this feature.

To reset all values in the Cycles option to factory default, press "Enter" when the "DEFAULT" prompt is shown. Press "Enter" again when the "RESET" prompt is shown to confirm the action.

The figure below shows the sub menu options for Cycles:

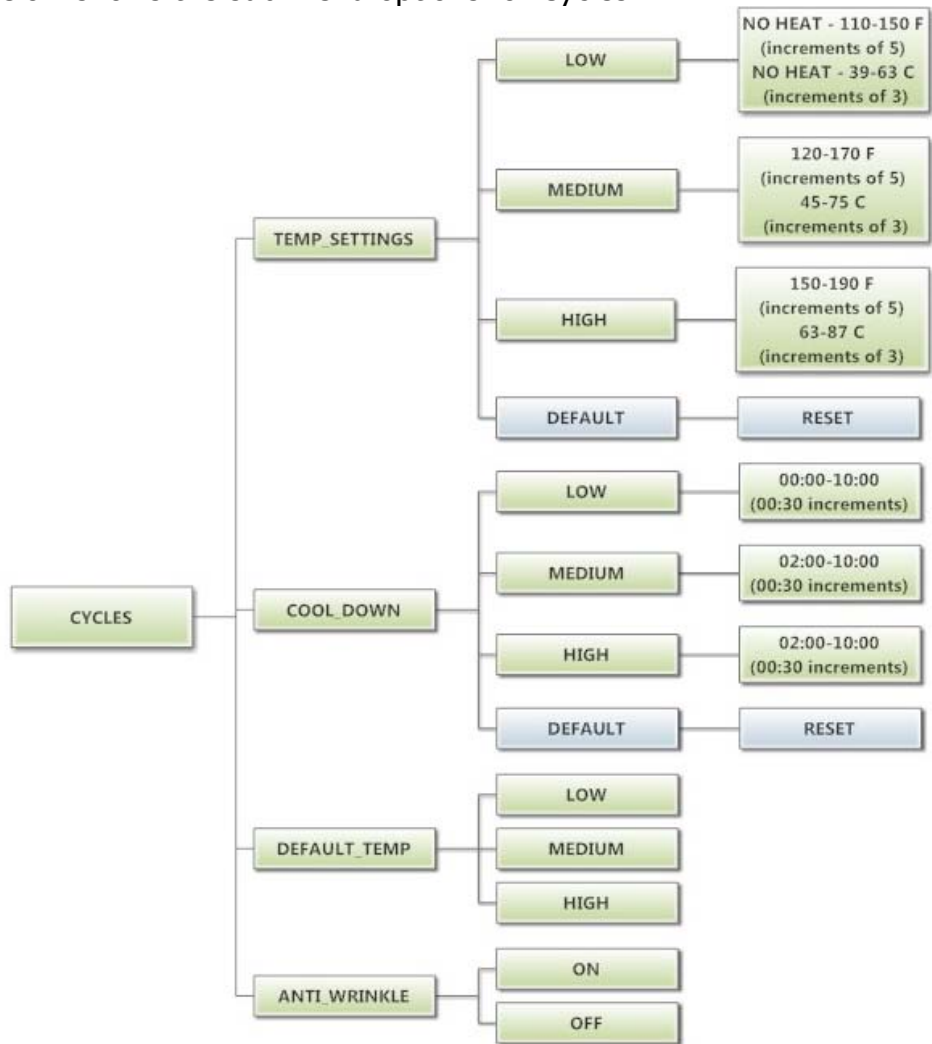

### Temperature Pricing Option:

This option allows the user to require additional vend amounts be added based on the drying temperature chosen by the customer. This pricing adder is effective only for the Base Vend Price (it does not affect the Extend Dry Price). It allows a pricing adder separate for "Medium" and "Hot" temperature settings.

Example- A store owner has programmed the control for the following:

Vend Price	\$1.00
Vend Time	30 minutes
Extend Dry Price	\$.25
Extend Dry Time	8 minutes
Medium Adder	\$.25
Hot Adder	\$.50

In this case, the Vend Price is displayed as:

\$1.00 if Low Temperature is chosen

\$1.25 if Medium Temperature is chosen

\$1.50 if Hot Temperature is chosen

When Temperature Pricing Adders are in place (user has chosen a higher value than \$0.00), if the customer attempts to change their temperature selection from a lower temperature to a higher one during a drying cycle, there will be no change in the temperature selection. The higher temperature buttons are disabled until the drying cycle is complete and a new Vend Price is required.

The figure below shows the sub menu options for Temperature Pricing:



## Settings Options:

The Settings options allow for the user to make various programming changes to change how the control operation affects the customer. See below for detailed information on each next level option.

1. "Decimal Point": If the user programs the Decimal Point to "OFF", control display will not show a decimal point on any vend price values. The factory default is "ON".
2. "Display Time": If the user programs this value to "MIN", then minutes only will be shown for the cycle time. If it is programmed to "MIN+SEC", then minutes and seconds will be shown. This also allows other programming changes, involving time, to be made in either minute increments or minutes & seconds increments, as desired.
3. "Temp Scale": If the user programs this value to "F", then the temperatures will be displayed in Fahrenheit units. If it is programmed to "C", then the temperature will be in Celsius units.
4. "Sounds": If the user programs the Sounds to "OFF", the control will not sound the enunciator at the end of a dry cycle. The factory default is "ON".
5. "Password": If the user programs the password to any value other than 0000, the control will prompt the user to enter a password (the programmed value) before manual programming can be accessed. The factory default is "0000" (no password).
  - a. Note that if the user forgets the Password, it can be reset to factory default (no password), by performing a hard reset on the control. Please refer to the appropriate section of this manual to understand how to perform a hard reset.
  - b. The individual digits of the Password can be set by using the "Up" or "Down" buttons to change the number that is flashing. Once the desired number is chosen for a single digit, press the "Enter" button to move to the next one. Once all four desired digits are chosen, the "Enter" button must be held down for 3 seconds to confirm that the complete password should be set.
6. "Central Pay": If the user programs this value to "ON", the left and right coin inputs become upper and lower dryer coin inputs.

Central Pay "OFF"	Central Pay "ON"
Left Coin Input	Upper Dryer Input
Right Coin Input	Lower Dryer Input

A system can then be installed that will register coin inputs per individual dryer remotely from a Central Pay kiosk. The left and right coin prices must be appropriately programmed. When this option is enabled, the controller will only display customer prompts for a designated dryer. This designated dryer is determined when coins are inserted at the Central Pay kiosk.

7. "Language": The control uses English for the default language of the customer prompts. Alternatively, the user can choose Spanish, French, Malay, or Italian for the customer display prompts. However, all other prompts, such as Manual Programming, USB Programming and any Error Codes will still display in English.
8. "Shift Hours": This feature allows the user to shift the time used by the control from the time kept internally by the control. The control uses a Real Time Clock (RTC) to internally track the time and date. The RTC continues operation even if the control loses external power. The RTC is set for Central Standard Time and no daylight savings. Because the machine may be located in another time zone, the user can choose to

create an alternate time & date that tracks in parallel to the RTC. When this alternate time is chosen, or shifted from the RTC, the alternate time will be used to, for example, track error code occurrences and set time-of-day pricing changes.

- a. The hours in "SHIFT HOURS" can be set by using the "Up" or "Down" buttons to change the number that is flashing. Once the desired hour shift is chosen, press the "Enter" button to move to the minutes. Once the hours and minute shift are both chosen, the "Enter" button must be held down for 3 seconds to confirm that the complete shifted time is set.
9. "Time": The control uses a Real Time Clock (RTC) to internally track the time and date. The RTC continues operation even if the control loses external power. The RTC is set for Central Standard Time and no daylight savings. However, if a problem occurs and the RTC time is not accurate, it can be reset to the current time using this option.
    - a. The hours in "TIME" can be set by using the "Up" or "Down" buttons to change the number that is flashing. Once the desired hour is chosen, press the "Enter" button to move to the minutes. Once the hours and minute are both chosen, the "Enter" button must be held down for 3 seconds to confirm that RTC is meant to be reset to the complete entry.
  10. "Date": Similar to "Time", if a problem occurs and the RTC date is not accurate, it can be reset to the current date using this option.
    - a. The day of the month in "DATE" can be set by using the "Up" or "Down" buttons to change the number that is flashing. Once the desired day of the month is chosen, press the "Enter" button to move to the month of the year. Once the desired month of the year is chosen, press the "Enter" button to move to the year. Once the day, month and year are all chosen, the "Enter" button must be held down for 3 seconds to confirm that RTC is meant to be reset to the complete entry.
  11. "Out of Service" – The control can be put into an Out-of-Service mode via manual programming. When the mode is "ON", the control will scroll "OUT OF SERVICE" on the display. The machine will not react to any vend input and will not operate when in this mode. The factory default is "OFF".

To reset all values in the Settings options to factory default, press "Enter" when the "DEFAULT" prompt is shown. Press "Enter" again when the "RESET" prompt is shown to confirm the action.

The figure below shows the sub menu options for Settings:

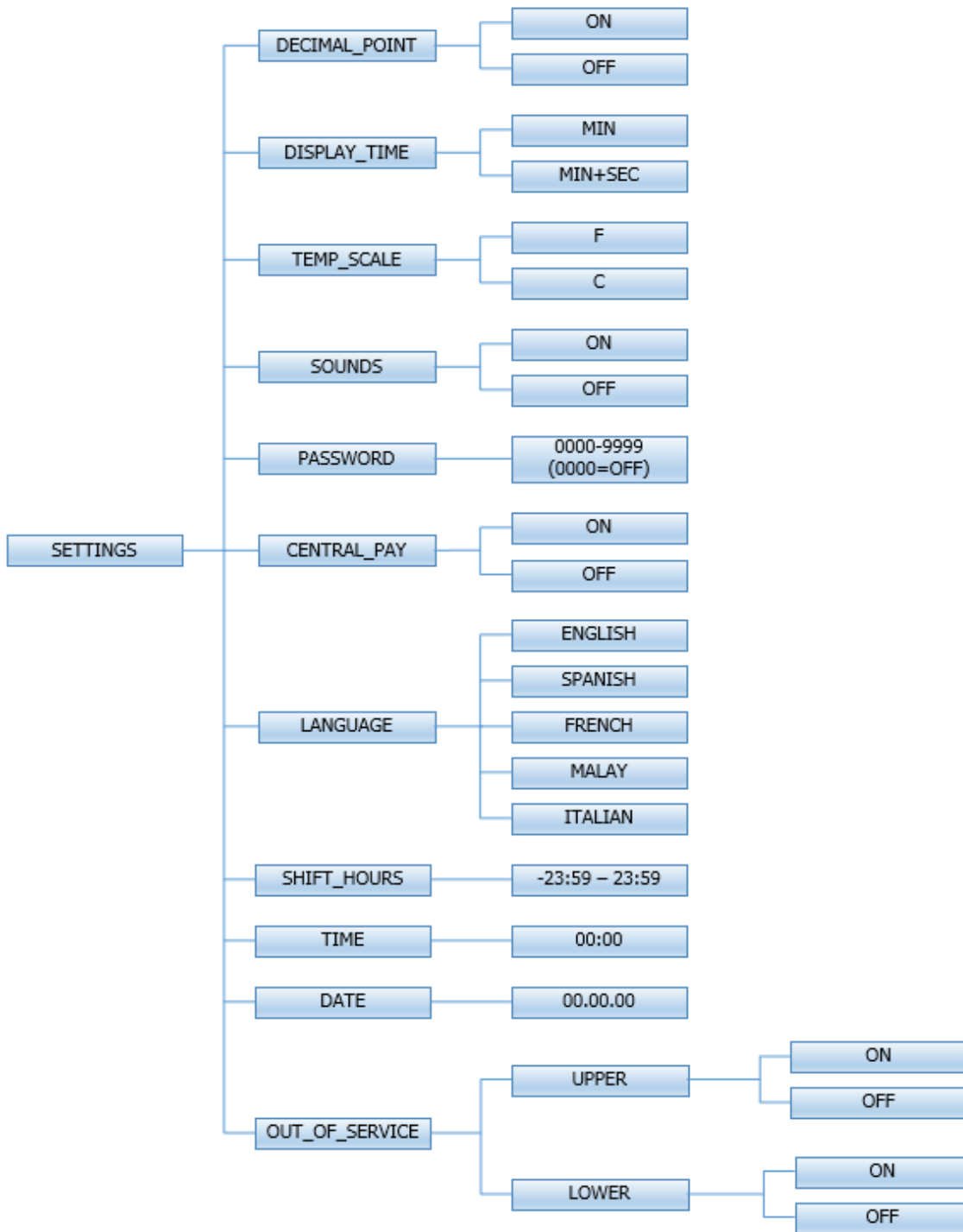

## Usage Menu:

The Usage menu allows for the user to track data about machine usage. See below for detailed information on each sub menu option.

1. "Coin Audit": The coin audit field shows the accumulation of coin pulses that were sent to the control over each of the left and right coin inputs. Note that this is a count of coin pulses, not an accumulated report of vend value.
  - a. The user can also return the coin audit amounts to the factory default setting (zero). To reset all coin audit values, press "Enter" when the "DEFAULT" prompt is shown. Press "Enter" again when the "RESET" prompt is shown to confirm the action.
2. "Motor Hours": The motor hours field shows the accumulated hours of operation for both the upper and lower motors independently. In many cases, it will match the cycle hours of the machine. However, separate fields are provided in the event that a motor is replaced on a machine. The user can set the motor hours to a designated number. For example, if it is necessary to replace the control on a machine, the new control could be programmed to show the motor hours that were recorded by the previously installed control. The individual digits of the hours count can be set by using the "Up" or "Down" buttons to change the number that is flashing. Once the desired digit of the hours is chosen, press the "Enter" button to move to the next digit. Once the complete hours are chosen, the "Enter" button must be held down for 3 seconds to confirm the action.
  - a. The user can also return the motor hours to the factory default setting (zero). To reset the motor hours, press "Enter" when the "DEFAULT" prompt is shown. Press "Enter" again when the "RESET" prompt is shown to confirm the action.
3. "Cycle Hours": The cycle hours field shows the accumulated hours of operation for both the upper and lower dryer dryers independently. In many cases, it will match the motor hours of the machine. However, separate fields are provided in the event that a motor is replaced on a machine. See the Motor Hours description for more information.

The figure below shows the sub menu options for Usage:

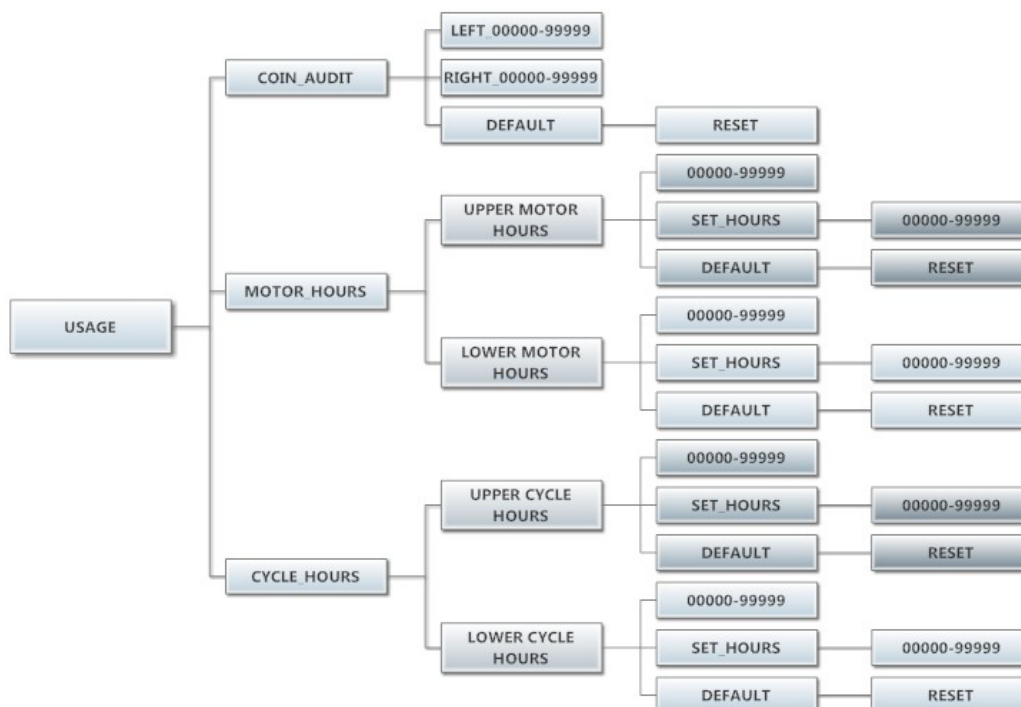

### Control Menu:

The Control menu allows for the user to observe important technical information for the control. No changes can be made at this menu. See below for detailed information on each sub menu.

1. "Serial Number": This is the control serial number.
2. "MAC Address": The MAC Address is a unique identifier designated to the control by the manufacturer. It allows the control to be recognized by network routers.
3. "IP Address": The IP Address is the identifier given to the control by a network system.
4. "M Firmware": The M Firmware is the Main Firmware currently loaded onto the control.
5. "C Firmware": The C Firmware is the Communications Firmware currently loaded onto the control.

The figure below shows the sub menu options for Control:

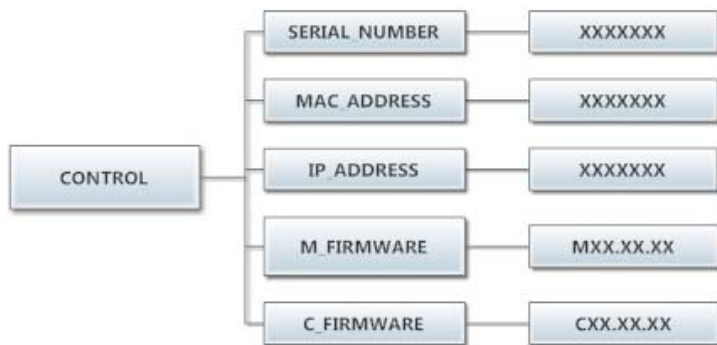



## SERVICING AND TROUBLESHOOTING

**CAUTION:** Label all wires prior to disconnection when servicing controls. Wiring errors can cause improper and dangerous operation. Verify proper operation after servicing.

**IMPORTANT:** Clothes should be removed from the dryer as soon as possible after the cycle is completed and then folded or hung to prevent excessive wrinkling.

If any of the following symptoms occur on this dryer, check the suggested remedies listed below. If all probable causes have been eliminated and the symptom still exists, contact your local Dexter agent for further troubleshooting assistance. See contact information in Preventative Maintenance section. Parts & Service Manuals from Dexter are also available for further troubleshooting assistance.

<b>Symptom</b>	<b>Probable Cause</b>	<b>Suggested Remedy</b>
Tumbler Does not turn	Control	Check that Control Display shows time available for drying. If not, deposit money as needed.
	Loading Door	Check that Loading Door is completely closed
	Lint Compartment Door	Check that Lint Compartment Door is completely closed.
Tumbler Turns, but heating element is off	Drive Belts	Check drive belts for excessive wear. Replace as needed.
	Circuit Breakers	Make sure circuit breakers are on.
	Heating Element Relay	Make sure relay is on and wires are connected.
Slow Drying	Heat Relay	Make sure relay is on and wires are connected.
	Control	Check that proper Temperature setting is chosen.
	Lint Screen	Clean Lint Screen
	Air flow Restrictions/ Make-up Air	Follow installation guidelines for static back pressure and make-up air
"Temp Sensor Short" or "Temp Sensor Open" Error Code displayed on control	Exhaust	Check exhaust for obstructions, follow installation guidelines
	Temperature Sensor	Press programming button to clear Error Code. If Error code persists, contact Dexter agent for assistance
"PCB Error" or "Comm Error" code displayed on control	Control Error	Cycle power to dryer to clear Error Code. If Error Code persists, contact Dexter Agent for Assistance

## **PREVENTIVE MAINTENANCE INSTRUCTIONS**

Note: A key with the markings "6324" is provided for service access to controller and another key with markings "6101" is provided for service access to the lint screens, both by a qualified person. These keys should be stored in a secure place away from the dryer. A different key is required to open the coin box, if provided.

### **DAILY (WARNING: Do not operate the dryer without the lint screen in place.)**

Use service key to gain access to the lint screen compartment.

1. Clean the lint screen. Use a soft brush if necessary.
2. Check the lint screen for tears. Replace if necessary.
3. Clean lint from the lint screen compartment.

Relock lower service door to prevent unauthorized access.

### **MONTHLY**

1. Remove lint accumulation from the end bells of the motor and the front control area.
2. Remove lint and dirt accumulation from the top of the dryer and all areas above, below, and around the heating elements and heater housing. Failure to keep this portion of the dryer clean can lead to a buildup of lint creating a fire hazard.
3. Place a few drops of general purpose lubricating oil on the clothes door hinge.
4. Grease the bearings and the shaft of the intermediate drive pulley. Use an Alemite grease gun and Molykote BR2-S grease and wear safety glasses.

### **QUARTERLY**

1. Check the belts for looseness, wear, or fraying.
2. Inspect the gasket of the door glass for excessive wear.
3. Check tightness of all fasteners holding parts to support channel.
4. Check tightness of all set screws.
5. Inspect the impeller for tightness of the blades to hub.
6. Check the tightness of the tumbler shaft retaining bolt.
7. Remove the air flow switch assembly and check the tumbler thru-bolts for tightness.
8. Apply a few drops of general purpose lubricating oil to each spacer tube on the tension arm assembly.
9. Apply general purpose grease to the pivot pins and the tension arms where in contact with each other.

### **SEMI-ANNUALLY**

1. Check electrical connections for the heating elements. Make sure connections are tight and wires are in good condition.
2. Remove all lint accumulation. Remove the front panel and the lint screen housing to remove lint.

### **ANNUALLY**

1. Check the intermediate pulley bearings for wear.
2. Check and remove any lint accumulation from the exhaust system.

**SERVICE PARTS      PART NUMBER**

**T30X2**

DRIVE BELT, MOTOR	9040-077-001
DRIVE BELT, TUMBLER	9040-073-009
LINT SCREEN FILTER	9555-057-002

For service and parts information, contact your local Dexter agent. If a Dexter agent is not available, contact **Dexter Laundry, Inc.** directly as listed below:

Mailing Address:    2211 West Grimes Avenue    Phone: 1-800-524-2954  
Fairfield, IA 52556 USA  
Website: [www.dexter.com](http://www.dexter.com)

DOW CORNING -- MOLYKOTE BR2-S GREASE -- 9150-00K000170

=====  
Product Identification  
=====

Product ID: MOLYKOTE BR2-S GREASE MSDS Date: 01/01/1985 FSC: 9150

NIIN: 00K000170 MSDS Number: BBZNK

=====  
Responsible Party  
=====

Company Name: DOW CORNING Emergency Phone Number: 517-496-5900

CAGE: 5D028

=====  
Contractor Identification  
=====

Company Name: DOW CORNING CORP Address: 3901 S SAGINAW RD Box: 997

City: MIDLAND State: MI ZIP: 48686-0997 Country: US

Phone: 517-496-6000/517-496-6315 CAGE: 5D028

Company Name: DOW CORNING CORP Address: 2200 W SALZBURG RD Box:

City: AUBURN State: MI ZIP: 48611 Country: US Phone: 517-496-4388 CAGE: 71984

=====  
Composition / Information on Ingredients  
=====

Ingredient Name: LITHIUM SOAP Fraction by Weight: 5%

Ingredient Name: MINERAL OIL (EXPOSURE REGULATED AS 'OIL MIST')CAS: 8012-95-1 RTECS #:

PY8030000 Fraction by Weight: >90% OSHA PEL: 5 MG/M3 ACGIH TLV: 5 MG/M3/10 STEL; 9192

Ingredient Name: ORGANIC LEAD Fraction by Weight: <1%

=====  
Hazards Identification  
=====

Effects of Overexposure: IRRITATES EYES

=====  
First Aid Measures  
=====

First Aid: FLUSH W/WATER

=====  
Fire Fighting Measures  
=====

Flash Point: >250 F OC Extinguishing Media: CARBON DIOXIDE OR FOAM

Fire Fighting Procedures: NONE Unusual Fire/Explosion Hazard: NONE

=====  
Accidental Release Measures  
=====

Spill Release Procedures: MOP, WIPE OR SOAK UP WITH ABSORBENT MATERIAL

=====  
Handling and Storage  
=====

Handling and Storage Precautions: NOTHING SPECIAL

=====  
Exposure Controls/Personal Protection  
=====

Respiratory Protection: NOT NEEDED Ventilation: GENERAL MECHANICAL RECOMMENDED

Protective Gloves: NOT NEEDED Eye Protection: SAFETY GLASSES

Other Protective Equipment: AS REQUIRED

Supplemental Safety and Health MFR STATED THAT PRODUCT IS OBSOLETE.

=====  
Physical/Chemical Properties  
=====

HCC: V6 Boiling Point: B.P. Text: >300 F Vapor Pressure: <5 Spec Gravity: 0.9

Evaporation Rate & Reference: <1, ETHER Solubility in Water : > 0.1 %

Appearance and Odor: PASTE-LIKE, VERY LITTLE ODOR Percent Volatiles by Volume: <5

=====  
Stability and Reactivity Data  
=====

Stability Indicator/Materials to Avoid: YES NONE KNOWN

Hazardous Decomposition Products: MOLYBDENUM & LITHIUM PROD, CO\*2, TRACES OF INCOMP BURNED CARBN

=====  
Disposal Considerations  
=====

Waste Disposal Methods: CAN BE LANDFILLED OR BURNED IN ACCORDANCE WITH LOCAL REGULATIONS.

Disclaimer (provided with this information by the compiling agencies): This information is formulated for use by elements of the Department of Defense. The United States of America in no manner whatsoever, expressly or implied, warrants this information to be accurate and disclaims all liability for its use. Any person utilizing this document should seek competent professional advice to verify and assume responsibility for the suitability of this information to their particular situation.



**EC DECLARATION OF CONFORMITY  
WITH COUNCIL DIRECTIVE 2006/42/EC**

Directive:	Machinery Directive on machinery safety, 2006/42/EC	
Conforming Machinery:	Commercial Drying System Model Numbers: DC30X2E, DC0030E, DC0050E, DC0080E, DCS030E Serial Numbers:	
Manufacturer:	Dexter Laundry, Inc. 2211 West Grimes Avenue Fairfield, IA 52556 USA	
Harmonised Standards Referenced or Applied:	EN ISO 12100:2010	Safety of machinery. General principles for design. Risk assessment and risk reduction.
	EN 349:1993+A1:2008	Safety of machinery. Minimum gaps to avoid crushing of parts of the human body.
	EN 614-1:2006+A1:2009	Safety of machinery. Ergonomic design principles. Terminology and general principles.
	EN 953:1997+A1:2009	Safety of machinery. Guards. General requirements for the design and construction of fixed and movable guards.
	EN 1037:1995+A1:2008	Safety of machinery. Prevention of unexpected start-up.
	EN ISO 13857:2008	Safety of machinery. Safety distances to prevent hazard zones being reached by upper and lower limbs.
	EN ISO 14119:2013	Safety of Machinery. Interlocking devices associated with guards. Principles for design and selection.
	EN ISO 10472-1:2008	Safety requirements for industrial laundry machinery. Common requirements.
	EN ISO 10472-4:2008	Safety requirements for industrial laundry machinery. Air Dryers.
	EN 60335-1:2012/AC:2014	Safety of machinery. Electrical equipment of machines. General requirements.
Specifications with which Conformity is Declared:	Essential Health and Safety Requirements of Annex1 of the Machinery Directive	
We hereby certify that the machinery described above conforms with the essential health and safety requirements of Council Directive 2006/42/EC on the approximation of the laws of the Member States relating to the safety of machinery.		
Date:		
Signed:		
Signatory:	Mark Cox Director of Engineering	



<b>EC DECLARATION OF CONFORMITY WITH COUNCIL DIRECTIVE 2004/108/EC</b>		
Directive:	Electromagnetic Compatibility Directive 2004/108/EC	
Conforming Machinery:	Commercial Drying System Model Numbers: DC30X2E, DC0030E, DC0050E, DC0080E, DCS030E	
Manufacturer:	Dexter Laundry, Inc. 2211 West Grimes Avenue Fairfield, IA 52556 USA	
Harmonised Standards Referenced or Applied:	EN 55014-1:2006/A2:2011 CISPR 14-1:2005/A2:2011	Electromagnetic compatibility. Requirements for household appliances, electric tools and similar apparatus. Emission.
	EN 55014-2:1997/A2:2008 CISPR 14-2:1997/A2:2008	Electromagnetic compatibility. Requirements for household appliances, electric tools and similar apparatus. Immunity. Product family standard.
	EN 61000-3-2:2014	Electromagnetic compatibility (EMC). Limits. Limits for harmonic current emissions (equipment input current $\leq 16A$ per phase).
	EN 61000-3-3:2013	Electromagnetic compatibility (EMC). Limits. Limitation of voltage changes, voltage fluctuations and flicker in public low-voltage supply systems, for equipment with rated current $\leq 16A$ per phase and not subject to conditional connection.
Specifications with which Conformity is Declared:	Electromagnetic Compatibility Directive	
We hereby certify that the machinery described above conforms with the essential health and safety requirements of Council Directive 2004/108/EC on the approximation of the laws of the Member States relating to the safety of machinery.		
Date:		
Signed:		
Signatory:	Mark Cox Director of Engineering	



## Declaration of Noise Emission

The Dexter Laundry Commercial Drying System Models Sound Pressure Levels per EN ISO 11202 as measured on similarly constructed models are as follows:

Model DCBD30KC-64FN	Operating	Idle
$L_{pAm}$ (Operator Position)	61 dB (A)	54 dB (A)
$L_{pAm}$ (Bystander Position)	68 dB (A)	58 dB (A)
Peak C-weight instantaneous SPL in the Operator's position	73 dB (C)	---
Sound power emitted where the equivalent continuous A-weighted SPL exceeds 80 dB (A).	N/A	---
The average difference between the extraneous noise level and the sound intensity level at each measuring point is:	$L_{pAm} \Delta = 9 \text{ dB (A)}$	
Ambient Correction Factor K3A calculated according to EN ISO 11204 Appendix A.	4 dB (A)	
Measurements were made at a height of 1.5 m and 1 m from the Operator Position and all four sides of the equipment.		
<p>The figures quoted are emission levels and are not necessarily safe working levels. While there is a correlation between the emission and exposure levels this cannot be used reliably to determine whether or not further precautions are required.</p> <p>Factors that influence the actual level of exposure of the workforce include characteristics of the work room, the other sources of noise, etc. such as the number of machines and other adjacent processes. Also, the permissible level of exposure can vary from country to country.</p> <p>This information, however, will enable the user of the machine to make a better evaluation of the hazard and risk.</p>		
	Dexter Laundry, Inc. 2211 West Grimes Avenue Fairfield, IA 52556 USA	