

# OPERATOR'S MANUAL

## For DCBD(30/50/80)KC-10/39 Series Dryers

The dryer must not be stored or installed where it will be exposed to water and/or weather.

**WARNING:** For your safety the information in this manual must be followed to minimize the risk of fire or explosion or to prevent property damage, personal injury or loss of life.

Do not store or use gasoline or other flammable vapors and liquids in the vicinity of this or any other appliance.

- WHAT TO DO IF YOU SMELL GAS
  - Do not try to light any appliance.
  - Do not touch any electrical switch; do not use any phone in your building.
  - Clear the room, building or area of all occupants.
  - Immediately call your gas supplier from a neighbor's phone. Follow the gas supplier's instructions.
  - If you cannot reach your gas supplier, call the fire department.
- Installation and service must be performed by a qualified installer, service agency, or the gas supplier.

Post the following "For Your Safety" caution in a prominent location:

### FOR YOUR SAFETY

Do not store or use gasoline or other flammable vapors or liquids in the vicinity of this or any other appliance.

It is important that you read this Manual and retain it for future reference. For service or replacement parts, contact the distributor in your area or the manufacturer.

**AVERTISSEMENT.** Assurez-vous de bien suivre les instructions données dans cette notice pour réduire au minimum le risque d'incendie ou d'explosion ou pour éviter tout dommage matériel, toute blessure ou la mort.

Ne pas entreposer ni utiliser d'essence ni d'autres vapeurs ou liquides inflammables dans le voisinage de cet appareil ou de tout autre appareil.

- QUE FAIRE SI VOUS SENTEZ UNE ODEUR DE GAZ:
  - Ne pas tenter d'allumer d'appareil.
  - Ne touchez à aucun interrupteur. Ne pas vous servir des téléphones se trouvant dans le bâtiment où vous vous trouvez.
  - Évacuez la pièce, le bâtiment ou la zone.
  - Appelez immédiatement votre fournisseur de gaz depuis un voisin. Suivez les instructions du fournisseur.
  - Si vous ne pouvez rejoindre le fournisseur de gaz, appelez le service des incendies.

- L'installation et l'entretien doivent être assurés par un installateur ou un service d'entretien qualifié ou par le fournisseur de gaz.

### POUR VOTRE SÉCURITÉ

Ne pas entreposer ni utiliser d'essence ni d'autres vapeurs ou liquides inflammables dans le voisinage de cet appareil ou de tout autre appareil.

You, the purchaser, must post in a prominent location instructions to be followed in the event the user smells gas. Consult your local gas supplier for procedure to be followed if the odor of gas is present.

## TABLE OF CONTENTS

	<b>PAGE NO.</b>
DRYER DIMENSIONS (Figure 1).....	3
DRYER CAPACITIES.....	6
UNCRATING.....	6
DRYER INSTALLATION.....	6
DRYER EXHAUST SYSTEM (Figure 2).....	10
DRYER SHUTDOWN.....	10
OPERATING INSTRUCTIONS.....	11
SERVICING AND TROUBLESHOOTING DRYER.....	16
PREVENTATIVE MAINTENANCE.....	17

## WARNINGS ABOUT USE AND OPERATION

It is **ABSOLUTELY ESSENTIAL** that the dryer be grounded to a known earth (zero) ground. This is not only for personal safety, but is necessary for proper operation.

**DO NOT MODIFY THIS APPLIANCE. KEEP SHIELDS, GUARDS, AND COVERS IN PLACE.** These safety devices are provided to protect everyone from injury.

**A DRYER SHOULD BE CONNECTED TO POWER FOR THREE (3) MINUTES** before it is operated or before a program change is made. Operation or program changes, which occur during this "power up" period, are subject to loss in case of power interruption. After the initial three minutes, all programmed data is protected from power interruptions of any length and the customer's individual cycle is protected up to 3 seconds. This is done without batteries.

**LEAVE ON THE ELECTRICAL POWER TO THE DRYER AT ALL TIMES** except when necessary for service or other similar activities. The hour meter function adds only full hours to its reading. If the power is shut off every night, any fraction of an hour of time that is on the machine at that time will be lost. Turning the power off every night could also have some effect on the long-term life of the memory after a number of years. Turning power off occasionally won't affect the unit.

**THIS DRYER IS EQUIPPED WITH AN OVER-TEMPERATURE THERMOSTAT** located to the right of the motor on the rear of the cabinet. If the dryer ceases to operate, refer to your "Service Procedure and Parts Data" book for instructions.

**CHECK THIS THERMOSTAT WHEN INSTALLING THE DRYER** to assure it is not tripped. Impacts such as rough handling in shipment, may trip the thermostat.

**DO NOT SPRAY AEROSOLS IN THE VICINITY OF THIS APPLIANCE** while in operation.

**THIS APPLIANCE SHALL NOT BE USED TO DRY OFF CLOTHES CONTAINING SOLVENTS OR DRY CLEANING FLUIDS.**

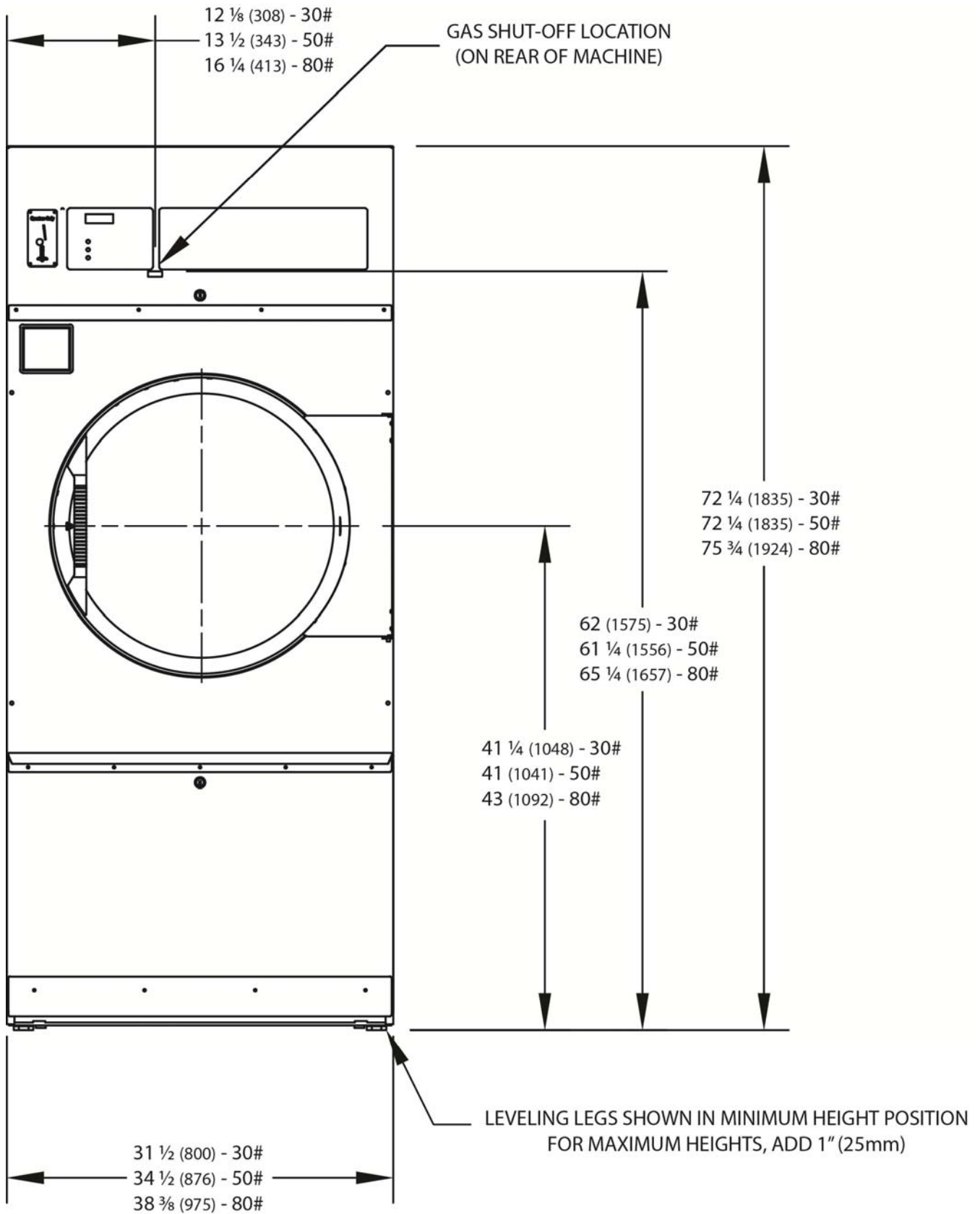

**DRYER DIMENSIONS- FIGURE 1A**

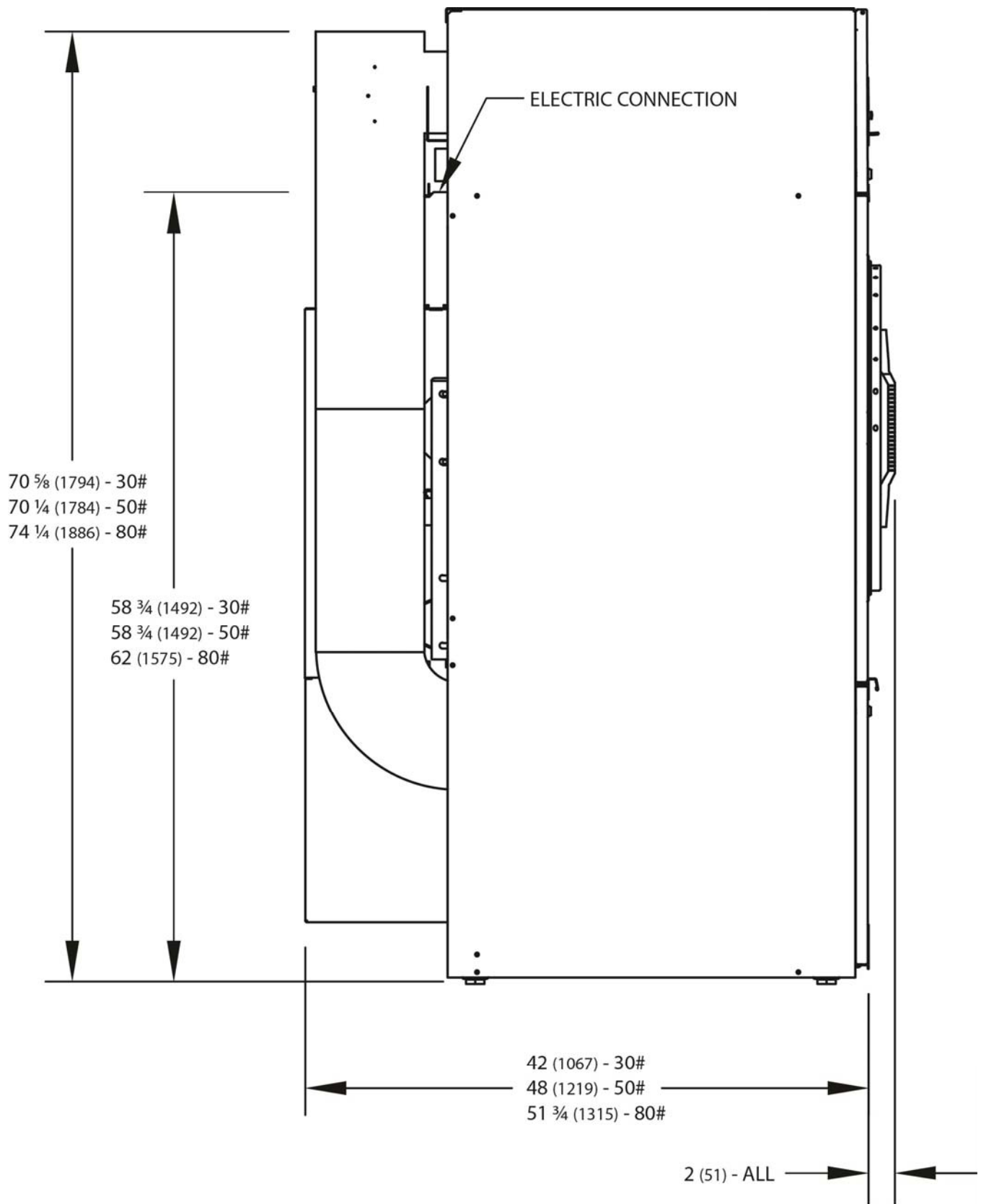

**DRYER DIMENSIONS- FIGURE 1B**

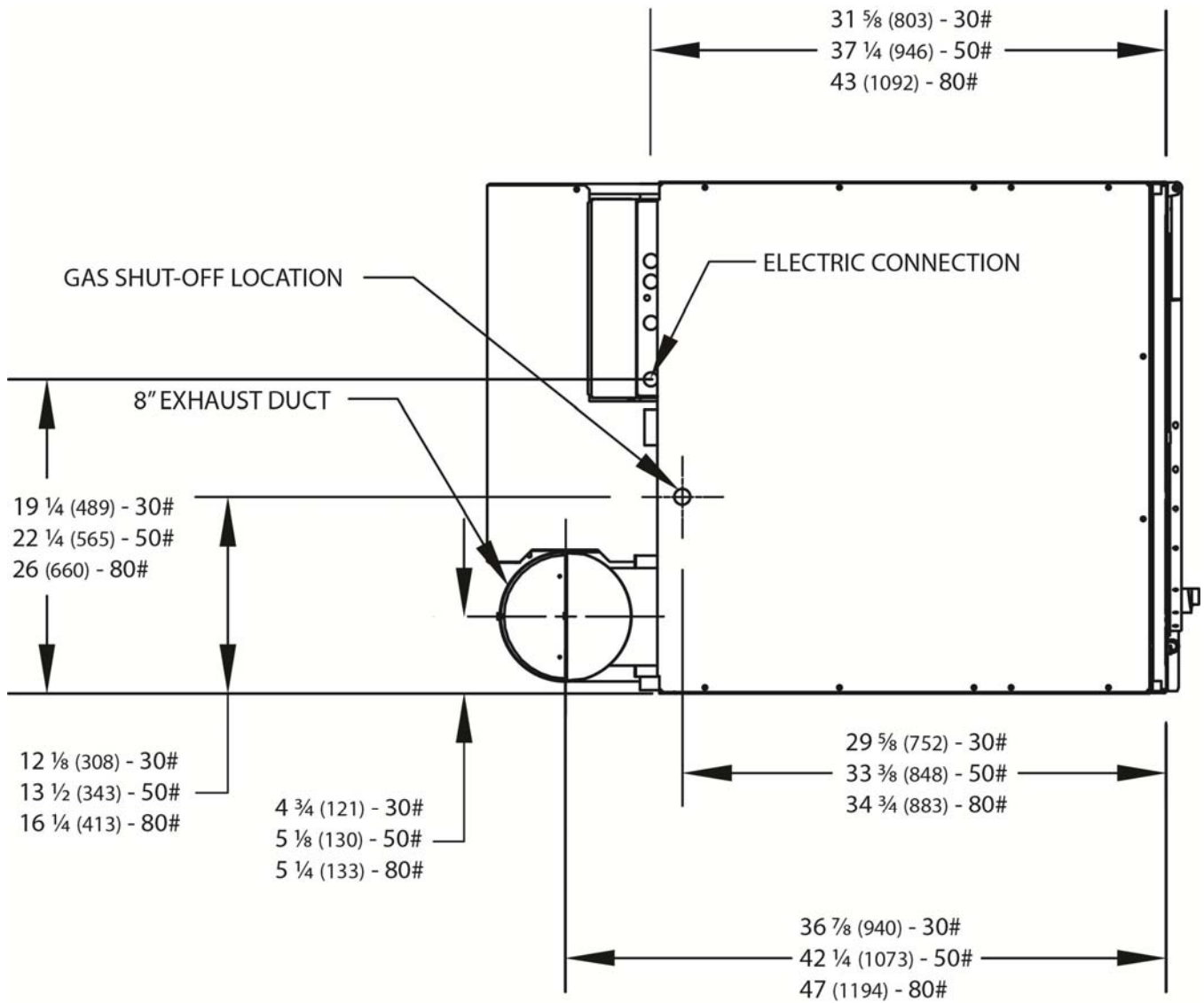

**DRYER DIMENSIONS- FIGURE 1C**

## DRYER CAPACITIES

Dryer Model	Dry Weight Capacity
DCBD30	30 lb (13.6 kg)
DCBD50	50 lb (22.7 kg)
DCBD80	80 lb (36.3 kg)

## INSTALLATION AND OPERATING INSTRUCTIONS COMMERCIAL DRYER

### UNCRATING

Tools required: 3/4" hex socket and ratchet driver, knife, channel-lock wrench that opens to 1 3/8".

1. Remove the plastic wrap with knife. Remove cardboard rails, fillers and top cap.
2. Using a ratchet and a 3/4" socket, remove the (4) bolts attaching the wooden skid to the dryer cabinet. Save the bolts for future moving of the dryer.
3. With a walking motion, move the dryer forward completely off the wooden skid. Save the skid for future moving of the dryer.
4. Using the channel-lock wrench, adjust the leveling legs to align the machine with adjacent units.

Note: If the dryer is ever moved again, the dryer should be re-mounted on its pallet and its crating bolts re-inserted and tightened, in the reverse order as above.

### DRYER INSTALLATION

1. **CODE CONFORMITY.** All commercial dryer installations must conform with local codes, or in the absence of local codes, with the latest edition of the National Fuel Gas Code ANSI Z223.1. Canadian installations must comply with the current Standard CAN/CGA-B149 (.1 or .2) Installation Code for Gas Burning Appliances or Equipment, and local codes if applicable. Australian installations must meet installation requirements and pipe sizing requirements of AS/NZA 5601. The appliance, when installed, must be electrically grounded in accordance with the latest edition of the National Electric Code, ANSI/NFPA70, or, when installed in Canada, with Standard CSA C22.1 Canadian Electrical Code Part 1.

2. **INSTALLATION CLEARANCES:** This unit may be installed at the following alcove clearance. (millimeters)

- I. Left Side 0"
- II. Right Side 0" \*
- III. Back 18" (457) (Certified for 1" (25) clearance; however, 18" (457) clearance is necessary behind the belt guard to allow servicing and maintenance.)
- IV. Front 48" (1220) (to allow use of dryer)
- V. Top Refer to figure on next page labeled "Vertical Clearance Dimensions".  
Certification allows 0" clearance at the top 1" (25) back from the front. However, a 1/4" (6) clearance is required to allow opening the upper service door.  
A 10" (254) clearance is required from the top at all other points.
- VI. Floor This unit may be installed upon a combustible floor.

\*Units may be installed in direct contact with an adjacent dryer, providing allowance is made for opening upper and lower service doors.

Do not obstruct the flow of combustion and ventilation air.

Maintain minimum of 1" (25) clearance between duct and combustible material.

Refer to installation label attached to rear guard for other installation information.

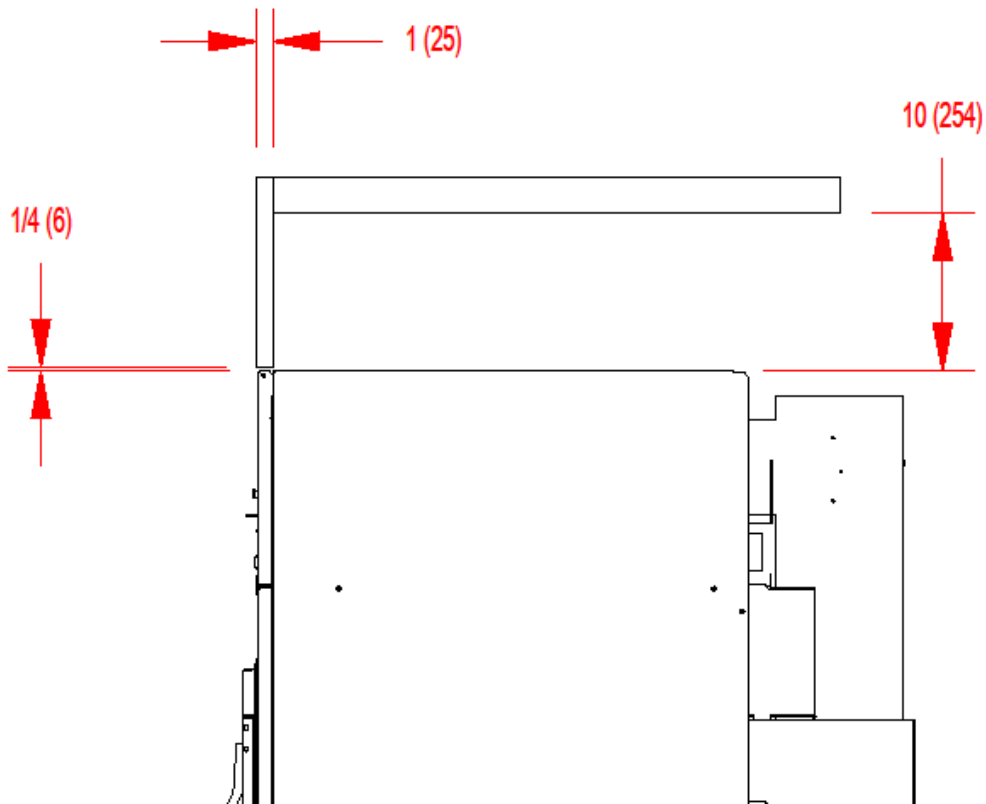

**VERTICAL CLEARANCE DIMENSIONS – ALL DCBD(30/50/80)**

**3. MAKE-UP AIR.** Adequate make-up air must be supplied to replace air exhausted by dryers on all types of installations. Provide a minimum air opening to the outside for each dryer as follows:

Dryer Model	Make-up Air Volume/Time	Make-up Air Opening Area (minimum)
DCBD30KC-10	830 CFM (23.5 m <sup>3</sup> /minute)	1 ft <sup>2</sup> (0.10 m <sup>2</sup> )
DCBD30KC-39	690 CFM (19.5 m <sup>3</sup> /minute)	1 ft <sup>2</sup> (0.10 m <sup>2</sup> )
DCBD50KC-10	850 CFM (23.5 m <sup>3</sup> /minute)	1.25 ft <sup>2</sup> (0.12 m <sup>2</sup> )
DCBD50KC-39	700 CFM (19.8 m <sup>3</sup> /minute)	1.25 ft <sup>2</sup> (0.12 m <sup>2</sup> )
DCBD80KC-10	1200 CFM (34.0 m <sup>3</sup> /minute)	1.5 ft <sup>2</sup> (0.14 m <sup>2</sup> )
DCBD80KC-39	1000 CFM (28.3 m <sup>3</sup> /minute)	1.5 ft <sup>2</sup> (0.14 m <sup>2</sup> )

This is a net requirement of effective area. Screens, grills or louvers, which will restrict the flow of air, must be considered. Consult the supplier to determine the free area equivalent for the grill being used.

The source of make-up air should be located sufficiently away from the dryers to allow an even airflow to the air intakes of all dryers. Multiple openings should be provided.

**NOTE:** The following considerations must be observed for gas dryer installations where dry cleaners are installed. The sources of all make-up air and room ventilation air movement to all dryers must be located away from any dry cleaners. This is necessary so that solvent vapors will not be drawn into the dryer inlet ducts. Dry cleaner solvent vapors will decompose in contact with an open flame such as the gas

flame present in clothes dryers. The decomposition products are highly corrosive and will cause damage to the dryer(s), ducts and clothes loads.

**4. ELECTRICAL REQUIREMENTS.** The electrical power requirements necessary to operate the unit satisfactorily are listed on the serial plate located on the back panel of each dryer. The electrical connection should be made to the terminal block in the rear control box assembly on the rear of the unit, using a wire size adequate to handle the amperage and voltage listed on the serial plate, but never smaller than No.12 AWG wire. It is absolutely necessary that the dryer be grounded to a known ground.

Individual circuit breakers for each unit are recommended. The wiring diagram is located on the belt guard on the back of the machine.

### **IMPORTANT: TRANSIENT VOLTAGE SURGE SUPPRESSORS**

Like most electrical equipment, your new machine can be damaged or have its life shortened by voltage surges due to lightning strikes which are not covered by factory warranty. Local power distribution problems also can be detrimental to the life of electrical components. We recommend the installation of transient voltage surge suppressors for your new equipment. These devices may be placed at the power supply panel for the complete installation and don't require an individual device for each machine.

These surge protectors help to protect equipment from large spikes and also from small ongoing spikes in the power that occur on a day to day basis. These smaller surges can shorten overall life of electrical components of all types and cause their failure at a later date. Although they can't protect against all events, these protective devices have a good reputation for significantly lengthening the useful life of electronic components. Electronic components are helped to have a longer useful life when they are supplied with the clean stable electrical power they like.

We are including the following names and phone numbers of a few suppliers of these devices for those who don't currently have a source.

<u>MANUFACTURER</u>	<u>CONTACT</u>	<u>PHONE</u>
Innovative Technology, Inc	Factory	1-800-647-8877 or <a href="http://www.itvss.com">www.itvss.com</a>
EFI Electronics Corporation	Factory Distributor – Surge Pro	1-800-877-1174 or <a href="http://www.efinet.com">www.efinet.com</a> 1-877-233-0153
MCG Surge Protection	Factory	1-800-851-1508 or <a href="http://www.mcgsurge.com">www.mcgsurge.com</a>
Advanced Protection Technologies Inc.	Factory	1-800-237-4567 or <a href="mailto:info@aptvss.com">info@aptvss.com</a>

**5. GAS REQUIREMENTS.** The complete gas requirements necessary to operate the dryer satisfactorily are listed on the serial plate located on the back panel of the dryer.

The inlet gas connection to the unit is 1/2-inch pipe thread.

A joint compound resistant to the action of liquefied petroleum gases should be employed in making pipe connections.

A 1/8 inch NPT plugged tapping, accessible for test gage connection, must be installed immediately upstream of the gas supply connection to the dryer.

A drip tee should be provided in the gas piping entering the unit to catch dirt and other foreign articles.

All pipe connections should be checked for leakage with soap solution. Never check with an open flame.

For altitudes above 2,000 feet (610m), it is necessary to derate the BTU input. Contact your local distributor for instructions.

L.P. gas conversion kits are available for this dryer. Contact your local distributor.



**CAUTION:** The dryer and its individual shutoff valve must be disconnected from the gas supply piping system during any pressure testing of that system at test pressures in excess of 1/2 psig. The dryer must be isolated from the gas supply piping system by closing its individual manual shutoff valve during any pressure testing of the gas supply piping system at test pressures equal to or less than 1/2 psig.

**6. EXHAUST INSTALLATION.** (Refer to Figure 2 at the end of section 6.) Exhausting of the dryer(s) should be planned and constructed so that no air restrictions occur. Any restriction due to pipe size or type of installation can cause slow drying time, excessive heat, and lint in the room.

From an operational standpoint, incorrect or inadequate exhausting can cause a cycling of the high limit thermostat which shuts off the main burners and results in inefficient drying.

Individual exhausting of the dryers is recommended. All heat, moisture, and lint should be exhausted outside by attaching a pipe of the proper diameter to the dryer adapter collar and extending it out through an outside wall. This pipe must be very smooth on the inside, as rough surfaces tend to collect lint which will eventually clog the duct and prevent the dryer from exhausting properly. All elbows must be smooth on the inside. All joints must be made so the exhaust end of one pipe is inside the next one downstream. The addition of an exhaust pipe tends to reduce the amount of air the blower can exhaust. This does not affect the dryer operation if held within practical limits. For the most efficient operation, it is recommended that no more than 20' (6m) of straight 8" diameter pipe be used with two right angle elbows. When more than two elbows are used, 2' (600mm) of straight pipe should be removed for each additional elbow. No more than four right angle elbows should be used to exhaust a dryer.

Maintain a minimum of 1" (25mm) clearance between duct and combustible material.

If the exhaust pipe passes through a wall, a metal sleeve of slightly larger diameter should be set in the wall and the exhaust pipe passed through this sleeve. This practice is required by some local codes and is recommended in all cases to protect the wall. This type of installation should have a means provided to prevent rain and high winds from entering the exhaust when the dryer is not in use. A hood with a hinged damper can be used for this purpose. Another method would be to point the outlet end of the pipe downward to prevent entrance of wind and rain. In either case, the outlet should be kept clear, by at least 24" (610mm), of any objects, which would cause an air restriction.

Never install a protective screen over the exhaust outlet.

When exhausting a dryer straight up through a roof, the overall length of the duct has the same limits as exhausting through a wall. A rain cap must be placed on top of the exhaust and must be of such a type as to be free from clogging. The type using a cone shaped "roof" over the pipe is suitable for this application.

Exhausting the dryer into a chimney or under a building is not permitted. In either case, there is a danger of lint build-up, which can be highly combustible.

Installation of several dryers, where a main discharge duct is necessary, will need the following considerations for installation (see Figure 2). Individual 8" (200mm) ducts from the dryers into the main discharge duct should be at a 45-degree angle in the direction of discharge airflow.

**NOTE:** Never install the individual 8" (200mm) ducts at a right angle into the main discharge duct. The individual ducts from the dryers can enter at the sides or bottom of the main discharge duct. Figure 2 indicates the various round main duct diameters to use with the individual dryer ducts. The main duct can be rectangular or round, provided adequate airflow is maintained. For each individual dryer, the total exhausting (main discharge duct plus duct outlet from the dryer) should not exceed the equivalent of 20 feet (6m) and two elbows. The diameter of the main discharge duct at the last dryer must be maintained to exhaust end.

**NOTE:** A small diameter duct will restrict airflow; a large diameter duct will reduce air velocity -- both contributing to lint buildup. An inspection door should be provided for periodic clean out of the main duct.

**NOTE:** STATIC BACK PRESSURE should be a maximum of 0.3 at the rear exhaust outlet of the dryer. If multiple dryers are connected to the common duct, ensure the back draft damper is installed properly.

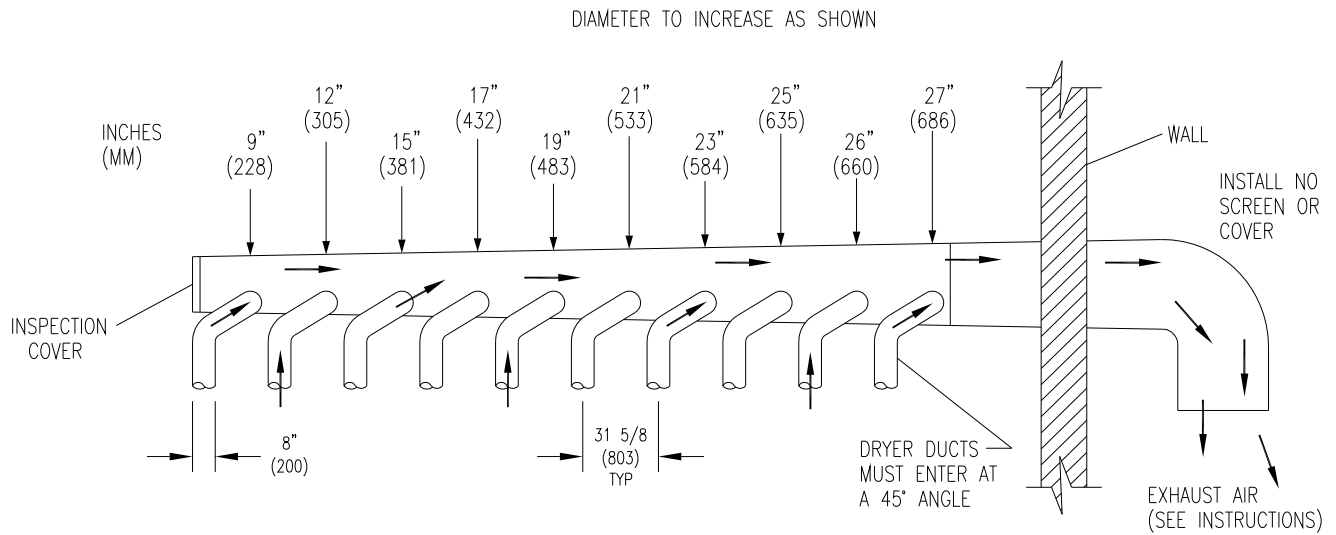

FIGURE 2– Dryer Exhausting Using A Main Discharge Duct.

**7. DRYER IGNITION (SOLID STATE IGNITION).** The solid-state ignition system lights the main burner gas by spark. The gas is ignited and burns only when the gas-valve relay (in the electronic controller) calls for heat. The procedure for first-time starting of a dryer is as follows:

- A. First, review and comply with the “WARNINGS ABOUT USE AND OPERATION” found on the inside front cover of this manual. Be sure the electrical power supply is connected correctly. The white (neutral) wire is to be connected to the N terminal while the black (line) wire to the L1 terminal of the terminal block in the rear control box. The dryer **MUST** be properly grounded.
- B. Make sure all gas supply lines are purged of air. Close the main gas shut-off valve and wait for five minutes before turning the valve back on.
- C. Turn on the main electrical power switch. The dryer may be started by following the “OPERATING INSTRUCTIONS” found later in this manual.
- D. Natural gas and liquefied petroleum gas fired dryers both operate in the same manner. When the gas-valve relay contacts are closed (indicating a demand for heat), the solid-state ignition control will automatically supply energy to the redundant gas valve. Spark will continue until a flame is detected by the sensing probe, but not longer than 10 seconds. If the gas fails to ignite within 10 seconds, the gas will shut off for 15 seconds. The control will attempt to ignite two more times in a similar manner. If the gas fails to ignite after three tries, the gas valve closes and the system will “lock out”. No further attempts at ignition will be performed automatically. It is then necessary to interrupt electrical power to the ignition system before making another attempt at igniting the burners. This can be done by opening the dryer door, allowing the dryer to come to a stop for 15 seconds, closing the door, and pushing the “Start” button. The dryer will then repeat the ignition trial cycle.

**DRYER SHUTDOWN**

To render the dryer inoperative, turn off the main gas shut-off valve and disconnect electrical power to the dryer.

**IT IS RECOMMENDED THAT THE INSTALLER TEST THE DRYER FOR OPERATION AND INSTRUCT THE USER BEFORE LEAVING THE INSTALLATION.**

## OPERATING INSTRUCTIONS

1. Deposit coins or tokens to satisfy vend price display of idle dryer. Each deposit decreases vend price until display changes to show time purchased. LOW light illuminates.

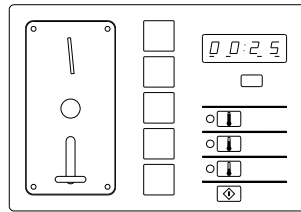

**VEND PRICE**

2. Select drying cycle. Other cycle selections may be made now or later by pressing the appropriate key (button).

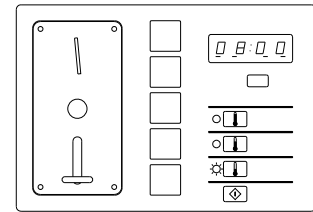

**MINUTES : SECONDS  
PURCHASED**

3. Close the loading door. Press "Start" button and the dryer will start. "Seconds" goes to 00. "Minutes" is rounded up and will count down each minute. The colon flashes on and off indicating the timer is counting down.

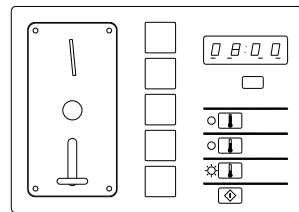

**START**

4. Clothes should be removed promptly after the cycle is completed to prevent excessive wrinkling.

Once started, the "timer" cannot be stopped. However, extra coins or tokens will be acknowledged by adding time to the display. The dryer may be stopped by opening the loading door, which interrupts the drive motor and gas burners. Close the loading door and push "Start" button to restart the dryer.

Cool-down time (owner programmable) is always part of the cycle time and is purchased by the customer. For example, if the cool-down time is 2 minutes, the last 2 minutes of the cycle will have no heat.

## DESCRIPTION OF CONTROLS

Credit for coins or tokens inserted, dryer time, and temperature are controlled by an electronic controller.

The large digital display shows vend price of an idle dryer, time purchased after coins or tokens are deposited, temperature, and program information.

The three red indicator lights show the drying temperature selected. This selection may be made anytime.

The drying temperature will be displayed when the "Start"  button and the temperature button for the selected temperature are pressed at the same time.







All programmed data is protected from power interruption of any length and the customer's individual cycle is protected for up to 3 seconds. This is done without batteries.

The 3 temperature buttons and the "Start"  button become programming switches when the controller is in the program mode as described on page 13.

## PROGRAMMING:

All operating parameters (vend price, temperatures, cool-down times, etc.) are adjustable. In addition, several displays of information are available from the controller (Money audits, hours run, dryer temperature).

The dryer is ready to run, from the factory, with the following pre-programmed data:

Temperature, HIGH 	175°F / 78°C
Temperature, MEDIUM 	150°F / 63°C
Temperature, LOW 	125°F / 48°C
Vend Price:	25¢
Time for Left Coin:	3:20 (doesn't apply to single coin models)
Time for Right Coin:	8:00 (8 minutes for 25¢)
Time of Free Vend:	8:00 ("Free Dry" cycle is 8 minutes)
Cool-down Time, HIGH 	2:00 (Cool-down time in HIGH is 2 minutes)
Cool-down Time, MEDIUM 	2:00 (Same as above, except MEDIUM)
Cool-down Time, LOW 	2:00 (Same as above, except LOW)
Temperature Scale	F degrees
Decimal Point Display	ON
Seconds on Display	OFF



All of the above data can be easily changed by the owner. The changes are made by the 4 keys or buttons on the front of the control panel.

# PROGRAMMING INSTRUCTIONS:

(To switch to program mode.)

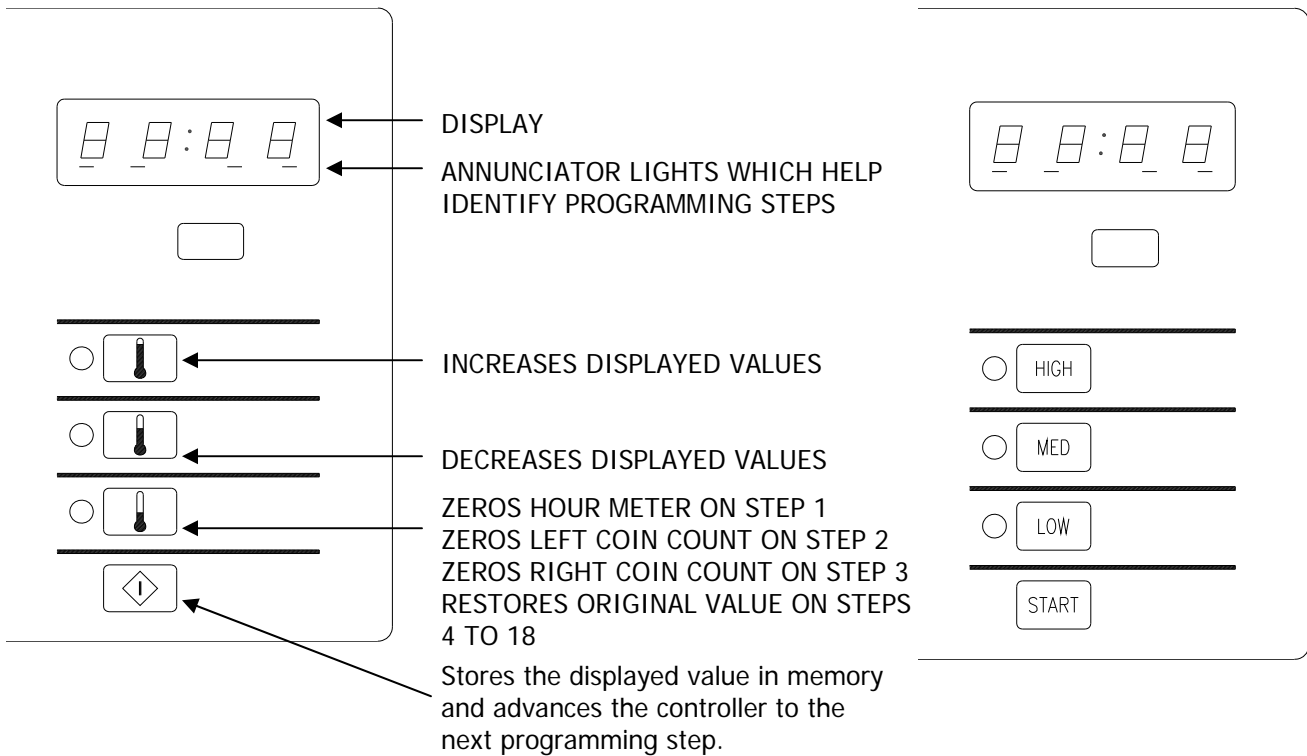
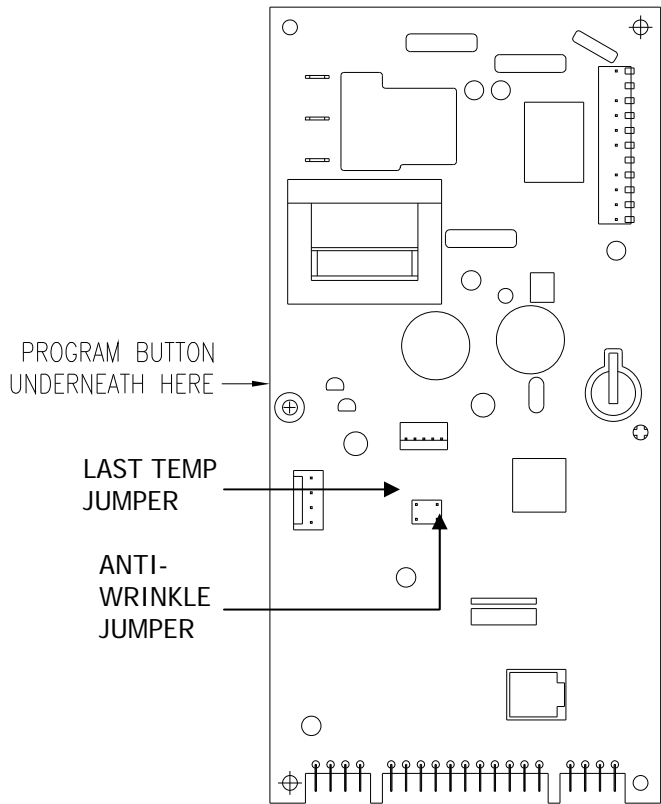
1. Unlock the upper service door and raise it until it can be held in place by the pivoting wire support.
2. Open the loading door and leave open.
3. Push the Program Button found between the service panel and the board. (Follow arrow on label)
4. Lower the upper service door to view the membrane switch keypad.
5. The control changes to PROGRAM mode. In PROGRAM mode, the membrane switch keypad becomes a 4-switch programming tool.
6. The ACTUAL NUMERICAL VALUES desired are keyed in as explained on page 14.



**IMPORTANT:** Please, remember to push "Start"  to actually enter (store in memory) new data. If you merely change the display, memory hasn't yet been changed -- only "Start"  will actually change the memory!





**ORDER OF PROGRAMMING STEPS:**

<b>CYCLE LIGHTS</b>	<b>DISPLAY</b>	<b>PROGRAMMING STEP</b>	<b>DESCRIPTION</b>	<b>OPTIONS/RANGE OF LIMITS</b>
		HOUR METER	Displays the hours of the "timer" operation.	May be reset to zero
HIGH,  MED,  LOW	— —	LEFT MONEY AUDIT	Number of pulses from the left acceptor (dual coin models).	May be reset to zero.
HIGH,  MED,  LOW	— —	RIGHT MONEY AUDIT	Number of pulses from the right acceptor (all models).	May be reset to zero.
HIGH	—	TEMPERATURE: HIGH	Median operating temperature-High (Regular).	150-190°F / 63-87°C
MEDIUM	—	TEMPERATURE: MEDIUM	Median operating temperature-Medium (Permanent Press).	120-170°F / 45-75°C
LOW	—	TEMPERATURE: LOW	Median operating temperature- Low (Delicate).	110-150°F / 39-63°C
	— —	LEFT COIN VALUE	Value of coin or token deposited through the left acceptor (dual coin models) in 1¢ increments.	0 through 9999¢
	— —	RIGHT COIN VALUE	Value of coin or token deposited through the right acceptor (all models) in 1¢ increments.	0 through 9999¢
	—	VEND PRICE	Money required to start the dryer in 1¢ increments.	0 through 9999¢ (0000 causes "Free Vend")
	— — —	TIME FOR LEFT COIN	Minutes and seconds awarded for one coin or token deposited through the left acceptor (dual coin models).	0 through 99:55 (minutes : seconds)
	— — —	TIME FOR RIGHT COIN	Minutes and seconds awarded for one coin or token deposited through the right acceptor (all models).	0 through 99:55 (minutes : seconds)
	—	TIME OF FREE VEND	Minutes and seconds of "Free" dry (If "Free" dry feature is used - see vend price above).	0 through 99:55 (minutes : seconds)
HIGH	— —	COOL-DOWN TIME: HIGH	Minutes and seconds of cool-down: High cycle	0 through 10 minutes
MEDIUM	— —	COOL-DOWN TIME: MEDIUM	Minutes and seconds of cool down: Medium cycle.	0 through 10 minutes
LOW	— —	COOL-DOWN TIME: LOW	Minutes and seconds of cool-down: Low cycle.	0 through 10 minutes
		TEMPERATURE SCALE	Sets Temperature Display to °F or °C	F or C
		DISPLAY: DECIMAL POINT	Displays decimal point in prices.	OFF or ON
		DISPLAY: SECONDS	Displays time remaining in minutes:00 (OFF) or in minutes:seconds (ON).	OFF or ON

## CHANGING PROGRAM DATA

Put the dryer in PROGRAM mode as instructed on page 13. The dryer remains in the PROGRAM mode until one of these actions occur:

- The Program Button is actuated again.
- The eighteenth step is completed and the "Start"  button is pushed following the eighteenth step.
- Programming is stopped for about a minute.
- The loading door is closed.

Observe the displayed value in each step. If no change is required, press "Start"  button to advance to the next program step. If a change is required, the values are made larger by the HIGH  button, smaller by the MED  button. The hour meter and the money audit can be reset to zero if the LOW  button is pressed.

Note that after any reset or program change, it is necessary to advance to the next step by pressing "Start"  button to enter the revision. OTHERWISE, THE VALUE WILL REMAIN AS IT WAS BEFORE THE ALTERATION.

### AVAILABLE OPTIONS



The following two features are available in the dryer. Disconnect power from the machine for two minutes before modifying the machine for either option.

#### Anti-Wrinkle Option

The dryer is shipped with this feature defeated. As shipped, when the machine stops at the end of the cycle, the load will sit motionless in the machine until the user removes the load. The feature is activated by removing the small jumper indicated in the figure of the PROGRAMMING INSTRUCTIONS. When the feature is activated, it comes into operation at the end of every cycle if the door is not opened within five minutes after the cycle finishes. At the end of this five-minute period, the machine will turn on and run for 10 seconds to redistribute the load. This will occur after each 5-minute interval that goes by without the door ever having been opened for up to 16 times. The opening of the door any time during this period will prevent any further occurrences for the particular cycle.

#### Last Temperature Used Option

There is a jumper on the control for this feature as shown in the figure of the PROGRAMMING INSTRUCTIONS. As shipped, from the factory, with the jumper in place, this feature is defeated. This means that at the beginning of each new cycle, the temperature will default to LOW  if another temperature isn't selected by the customer.

If the jumper is removed from the control, the operation is changed, so that when starting a new cycle, the temperature remains at the last temperature selection used in the previous cycle. This would mean if the previous customer has used a HIGH  selection and the next customer didn't select anything different, they also would receive a HIGH  cycle.

## **SERVICING AND TROUBLESHOOTING**

**CAUTION:** Label all wires prior to disconnection when servicing controls. Wiring errors can cause improper and dangerous operation. Verify proper operation after servicing.

**ATTENTION.** Lors des opérations d'entretien des commandes, étiqueter tous les fils avant de les déconnecter. Toute erreur de câblage peut être une source de danger et de panne.

If any of the following symptoms occur on this dryer, check the suggested remedies listed below. If all probable causes have been eliminated and the symptom still exists, contact your local Dexter agent for further troubleshooting assistance. See contact information in Preventative Maintenance section. Parts & Service Manuals from Dexter are also available for further troubleshooting assistance.

<b>Symptom</b>	<b>Probable Cause</b>	<b>Suggested Remedy</b>
Tumbler Does not turn	Control	Check that Control Display shows time available for drying. If not, deposit money as needed.
	Loading Door	Check that Loading Door is completely closed
	Lint Compartment Door	Check that Lint Compartment Door is completely closed.
	Drive Belts	Check drive belts for excessive wear. Replace as needed.
Tumbler Turns, but no burner flame is present	Gas shut-off valve	Make sure gas shut-off valve is in the open position
	Ignition Module	Follow the procedure for checking the ignition cycle listed in Dryer Ignition section of this manual.
Slow Drying	Control	Check that proper Temperature setting is chosen.
	Lint Screen	Clean Lint Screen
	Air flow Restrictions/ Make-up Air	Follow installation guidelines for static back pressure and make-up air
	Exhaust	Check exhaust for obstructions, follow installation guidelines
F1 or F2 Fault Code displayed on control	Temperature Sensor	Contact Dexter agent for assistance
F3, F4, F5 Fault Code displayed on control	Control Error	Cycle power to dryer to clear Fault Code or Contact Dexter Agent for Assistance



# PREVENTIVE MAINTENANCE INSTRUCTIONS

## DAILY

1. Clean the lint screen. Use a soft brush if necessary.
2. Check the lint screen for tears. Replace if necessary.
3. Clean lint from the lint screen compartment.

## MONTHLY

1. Remove lint accumulation from the end bells of the motor.
2. Remove lint accumulation from front control area.
3. Remove lint and dirt accumulation from the top of the dryer and all areas above, below, and around the burners and burner housing. Failure to keep this portion of the dryer clean can lead to a build-up of lint creating a fire hazard.
4. Place a few drops of light oil on the clothes door hinge.
5. Grease the bearings and the shaft of the intermediate drive pulley. Use an Alemite grease gun and Molykote BR2-S grease.

## QUARTERLY

1. Check the belts for looseness, wear, or fraying.
2. Inspect the gasket of the door glass for excessive wear.
3. Check tightness of all fasteners holding parts to support channel.
4. Check tightness of all set screws.
5. Inspect the impeller for tightness of the blades to hub.
6. Check the tightness of the tumbler shaft retaining bolt.
7. Remove the air flow switch assembly and check the tumbler thru-bolts for tightness.
8. Remove lint accumulation from the primary air ports in the burners.
9. Apply a few drops of oil to each spacer tube on the tension arm assembly.
10. Grease the pivot pins and the tension arms where in contact with each other.

## SEMI-ANNUALLY

1. Remove and clean the main burners.
2. Remove all orifices and examine for dirt and hole obstruction.
3. Remove all lint accumulation. Remove the front panel and the lint screen housing and remove lint accumulation.

## ANNUALLY

1. Check the intermediate pulley bearings for wear.
2. Check and remove any lint accumulation from the exhaust system.

<u>SERVICE PARTS</u>	<u>PART NUMBER</u>		
	<b>DCBD30KC-10/39</b>	<b>DCBD50KC-10/39</b>	<b>DCBD80KC-10/39</b>
DRIVE BELT, MOTOR	9040-076-003	9040-076-006	9040-076-011
DRIVE BELT, TUMBLER	9040-073-009	9040-073-011	9040-073-012
LINT SCREEN FILTER	9822-026-002	9822-026-001	9822-031-002

For service and parts information, contact your local Dexter agent. To find your local Dexter agent, use the Distributor Locator at the website shown below. If a Dexter agent is not available, contact **Dexter Laundry, Inc.** directly as listed below:

Mailing Address: 2211 West Grimes Avenue Phone: 1-800-524-2954  
Fairfield, IA 52556  
USA

Website: [www.dexterlaundry.com](http://www.dexterlaundry.com)