



DEXTER
LAUNDRY











Dexter Commercial Vended Dryer

C-Series 120# Single Tumbler

Parts & Service Manual

Equipment Safety Warnings

Symbols and Terminology Used in this Equipment

	Indicates on
	Imminently hazardous situation, which if not avoided, will result in death or serious injury.
	Indicates a potentially hazardous situation, which if not avoided could result in death or serious injury.
	Indicates a potentially hazardous situation which, if not avoided, may result in minor or moderate injury. It may also be used to alert against unsafe practices. Minor burns, pinch points that result in bruises and minor chemical irritation.
	Indicates information or a company policy that relates directly or indirectly to the safety of personnel or protection of property.
	This is the user caution symbol. It indicates a condition where damage to the equipment resulting in injury to the operator could occur if operational procedures are not followed. TO REDUCE THE RISK OF DAMAGE OR INJURY, refer to accompanying documents; follow all steps or procedures as instructed.
	This is the electrical hazard symbol. It indicates that there are DANGEROUS HIGH VOLTAGES PRESENT inside the enclosure of this product. TO REDUCE THE RISK OF FIRE OR ELECTRIC SHOCK, do not attempt to open the enclosure or gain access to areas where you are not instructed to do so. REFER SERVICING TO QUALIFIED SERVICE PERSONNEL ONLY!
	Caution! There are sharp edges on various sheet metal parts internal to the enclosure. Use safety consciousness when placing or moving your hands while working in the interior of this equipment.
	Caution! To reduce the risk of damage to the Water Inlet Valve, do not supply inlet water with a temperature that exceeds 70° C. Caution! To reduce the risk of fire or explosion, do not operate this equipment in any hazardous classified (ATEX) environment.

Equipment Safety Warnings

Symbols and Terminology Used in this Equipment



Warning! Do not operate equipment if door glass is damaged in any way.



Warning! Keep clear of rotating parts.



Prohibited! Do not enter this equipment or space.



Prohibited! Do not step or stand on this equipment.



Prohibited! Do not operate without all guards and covers in place.









Prohibited! Do not operate without all guards and covers in place.



Prohibited! Do not wash or Dry clothing impregnated with flammable liquids (petrochemical).







Prohibited! Do not allow children to play in or around equipment.

	<p>Indicates an imminently hazardous situation, which if not avoided, <u>will result</u> in death or serious injury.</p>
	<p>Indicates a potentially hazardous situation, which if not avoided <u>could result</u> in death or serious injury.</p>
	<p>Indicates a potentially hazardous situation which, if not avoided, <u>may result</u> in minor or moderate injury. It may also be used to alert against unsafe practices. Minor burns, pinch points that result in bruises and minor chemical irritation.</p>
	<p>Indicates information or a company policy that relates directly or indirectly to the safety of personnel or protection of property.</p>
	<p>This is the user caution symbol. It indicates a condition where damage to the equipment resulting in injury to the operator could occur if operational procedures are not followed. TO REDUCE THE RISK OF DAMAGE OR INJURY, refer to accompanying documents; follow all steps or procedures as instructed.</p>
	<p>This is the electrical hazard symbol. It indicates that there are DANGEROUS HIGH VOLTAGES PRESENT inside the enclosure of this product. TO REDUCE THE RISK OF FIRE OR ELECTRIC SHOCK, do not attempt to open the enclosure or gain access to areas where you are not instructed to do so. REFER SERVICING TO QUALIFIED SERVICE PERSONNEL ONLY</p>
	<p>Caution! To reduce the risk of fire or explosion, do not operate this equipment in any hazardous classified (ATEX) environment.</p>



WARNING

	<ul style="list-style-type: none">• All Dryers must be installed in accordance to all applicable electrical, plumbing and all other local codes.• These installation and operation instructions are for use by qualified personnel only. To avoid injury and electrical shock, do not perform any servicing other than that contained in the installation and operation instructions, unless qualified.
	<p>Do not install Equipment in an explosive atmosphere.</p>
	<ul style="list-style-type: none">• Care must be stressed with all foundation work to ensure a stable unit installation, eliminating possibilities of excessive vibration.• Foundation must be level within 13 mm to ensure proper washer operation.
	<p>Do not operate washer or Dryer if door glass is damaged in any way.</p>
	<p>Do not wash or Dry clothing impregnated with flammable liquids (petrochemical).</p>



WARNING





	<p>Children should be supervised to ensure they do not operate or play in or around equipment.</p>
	<p>Keep all panels in place to protect against electrical shock and injury and add rigidity to washer.</p>

This appliance is not intended for use by persons (including children) with reduced physical, sensory or mental capabilities, or lack of experience and knowledge, unless they have been given supervision or instruction concerning use of the appliance by a person responsible for their safety.

A washer should not be allowed to operate if any of the following occur:

- **Excessive high water level.**
- **Machine is not connected to a properly earthed circuit.**
- **Door does not remain securely locked during the entire cycle.**
- **Vibration or shaking from an inadequate mounting or foundation.**

	<p>Warning! Do not operate equipment if door glass is damaged in any way.</p>
	<p>Warning! Keep clear of rotating parts.</p>
	<p>Prohibited! Do not enter this equipment or space.</p>
	<p>Prohibited! Do not step or stand on this equipment.</p>
	<p>Prohibited! Do not operate without all guards and covers in place.</p>
	<p>Prohibited! Do not operate without all guards and covers in place.</p>
	<p>Prohibited! Do not wash or Dry clothing impregnated with flammable liquids (petrochemical).</p>
	<p>Prohibited! Do not allow children to play in or around equipment.</p>

	<p>Prohibited! Do not attempt to open, touch, or proceed before referring to the manual or unless qualified.</p>
	<p>Mandatory! Read all supporting documentation before operating or maintaining equipment.</p>
	<p>Mandatory! Disconnect power before servicing equipment.</p>
	<p>Mandatory! Lock out and tag out before servicing this equipment.</p>
	<p>Mandatory! Children should be supervised to ensure they do not operate equipment.</p>

Dexter Safety Guidelines



WARNING

These washers are equipped with devices and features relating to their safe operation. To avoid injury or electrical shock, do not perform and service, unless qualified to do so.



WARNING

For your safety, the information in this manual must be followed to minimize the risk of fire or explosion or to prevent property damage, personal injury or loss of life.

IF YOU SMELL GAS:

- Do not try to light any appliance.
- Do not touch any electrical switch: do not use any telephone in your building.
- Clear the room, building or area of all occupants.
- Immediately call your gas supplier from a neighbor's telephone.
- Follow the gas supplier's instructions.
- If you cannot reach your gas supplier, call the fire department. Installation and service must be performed by a qualified installer, service agency or the gas supplier.

Dry only fabrics washed in water to avoid the risk of fire, including spontaneous combustions, do not dry:

- Items containing foam rubber, or any similarly textured rubber-like materials.
- Any items on which you have used a cleaning solvent or which contain flammable liquids or solids, such as naphtha, gasoline, or other oils or waxes.

To activate your warranty, be sure to return your red warranty form to the factory. Please have serial number and model ready when calling for assistance.

Table of Contents

Section 1: Specifications & Installation

Specifications, Mounting Dimensions	
Specifications. & Dimensions 30Lb.....	12 & 13
Specifications. & Dimensions 50Lb.....	14 & 15
Specifications. & Dimensions 80Lb.....	16 & 17
Dryer Installation & Clearances.....	18
Dryer Make up air	19
Electrical Requirements.....	19 & 20
Gas Requirements.....	20
Exhaust Installation	20 & 21
Dryer Ignition & Testing	22

Section 2: Operating Instructions

Dryer Operating Instructions	27
------------------------------------	----

Section 3: Dryer Programming Instructions

DexterLive setup & programing USB	30-39
Dryer Programming.....	40-53

Section 4:

Dryer Service, Troubleshooting and Schematics	
Dryer Service Procedures.....	56-65
Dryer Troubleshooting Tips.....	66-68
Dryer Schematics & Diagrams 60hz	70 & 71

Section 5:

Dryer Parts Data	74-105
------------------------	--------

Section 6:

Maintenance	
Dryer.....	108



Section 1:

Dryer

Specifications &
Installation

Machine Specifications: 120Lb

120 lb. Commercial Dryer: T-120 – DC0120NE-10EC2R (60 Hz), DC0120NE-39AB2R (50 Hz)

Cabinet Height	85 5/16"	2167 mm.
(Assumes minimum leveling leg adjustment)		
Cabinet Width	46 3/4"	1187 mm.
Overall Depth	60 3/16"	1528 mm.
Floor to Door Center	34"	864 mm.
Door Opening	30"	762 mm.
Dry Wt. Capacity	120 Lbs.	54.4 kg.
Cylinder Diameter	43"	1092 mm.
Cylinder Depth	43"	1092 mm.
Cylinder Volume	31.6 cu. ft.	1022.2 liters
Lint Screen Area	862 sq. in.	5561 sq. cm.
Gas Input (60 hz)	320,000 Btu/hr	338 MJ/hr (93.8 kW)
Gas Input (50 hz)	300,000 Btu/hr	317 MJ/hr (87.4 kW)
Gas Supply Connection	3/4"	19.1 mm.
Natural Gas Supply (Water Column)	5-8"	127 mm. - 203 mm.
Natural Burner Manifold	3 1/2"	88.9 mm.
L.P. Supply (Water Column)	11.5 -13.5"	292 mm. - 343 mm.
L.P. Burner Manifold	11"	279 mm.
Exhaust Size	10 or 12"	254 or 305 mm.
Make-up Air	2.25 sq. ft.	2090 sq. cm.
Example: 1.0 sq. ft. = 1 ft. long X 1 ft. wide		
Motor Size	1 H.P.	0.746 kW
Airflow (60 hz), 10"	1250 CFM	35.4 m ³ /min
Airflow (60 hz), 12"	1450 CFM	41.1 m ³ /min
Airflow (50 hz), 10 or 12"	1000 CFM	28.3 m ³ /min

Electrical Specifications - 120/60/1

Voltage/Hz/Phase	120VAC/60Hz/1Phase	
Running Amps	15	
Circuit Protection Amps	25	
Wire Size	12 gauge	
Electrical Service	2 wire + ground	

Electrical Specifications - 220-240/50/1

Voltage/Hz/Phase	220-240VAC/50Hz/1Phase	
Running Amps	10	
Circuit Protection Amps	20	
Wire Size	3.5 mm ²	
Electrical Service	2 wire + ground	

Shipping Weight	1090 Lbs.	494 kg.
Net Weight	950 Lbs.	431 kg.
Clearance Behind Machines (min.)	18"	457 mm.

Machine Dimensions: 120Lb

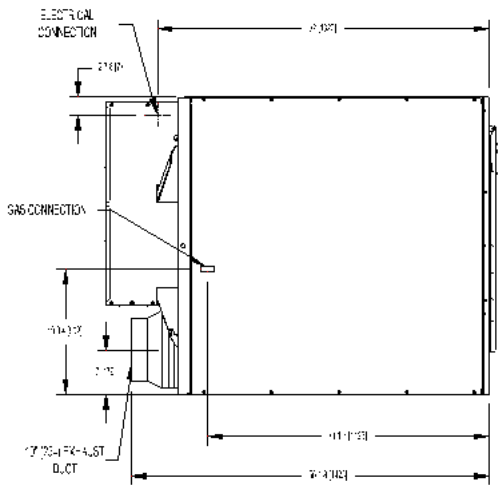
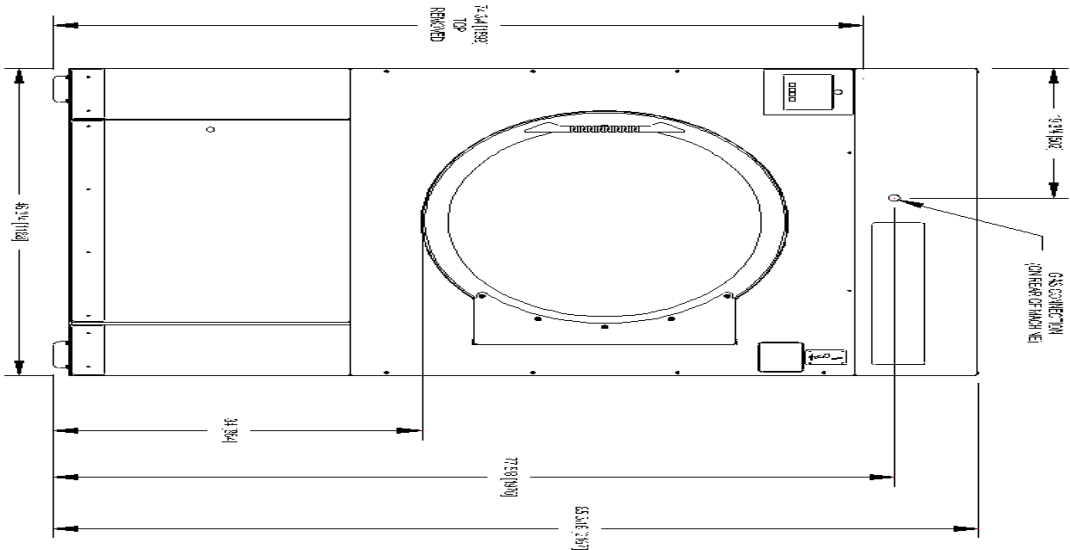
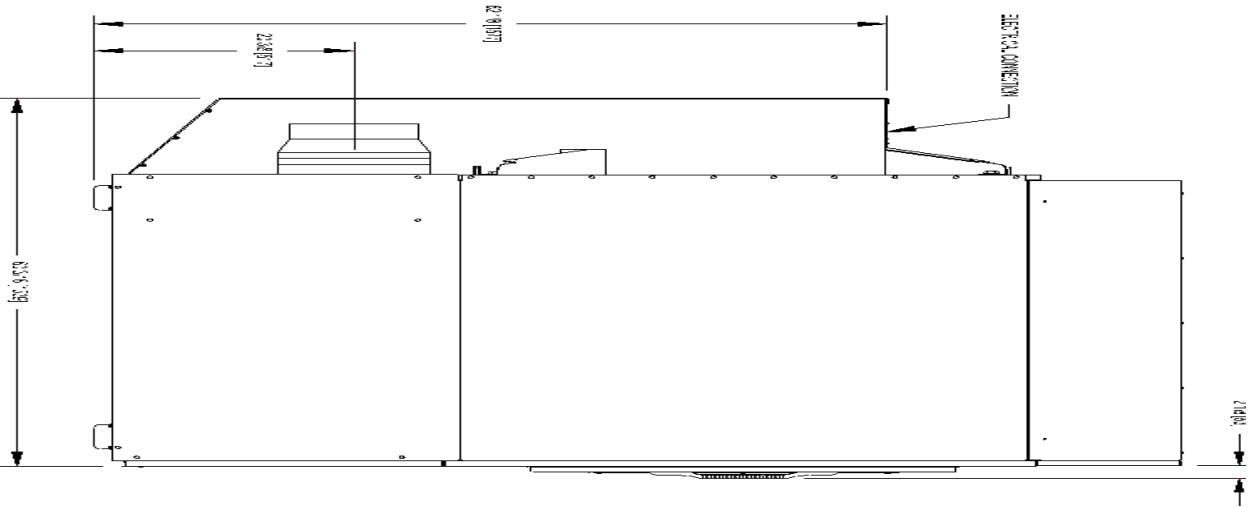

Dryer Installation

All commercial dryer installations must conform with local applicable local codes or in the absence of local codes, with the National Fuel Gas Code ANSI Z223.1A-1988. Canadian installations must comply with current standard CAN/CGA-B149(.1 or .2) Installation Code for Gas Burning Appliances or Equipment, and local codes if applicable. The appliance, when installed, must be electrically grounded in accordance with the National Electric Code, ANSI/NFPA No. 70-1990, or when installed in Canada, with Standard CSA C22.1 Canadian Electrical Code Part 1.

Installation Clearances:

This unit may be installed at the following alcove clearances. (Millimeters)

1. Left side- 0"
2. Right side- 0" *
3. Back- 18" (457) (Certified for 1" (25) clearance; however, 18" (457) clearance is necessary behind the belt guard to allow servicing and maintenance.)
4. Front- 48" (1220) (to allow use of dryer)
5. Top- Refer to figure labelled "Vertical Clearance Dimensions".
Certification allows 0" clearance at the top 1" (25) back from the front. However, a 1/4" (6) clearance is required to allow opening the upper service door. A 10" (254) clearance is required from the top at all other points.
6. Floor- This unit may be installed upon a combustible floor.
*Units may be installed in direct contact with an adjacent dryer, providing allowance is made for opening upper and lower service doors.
Do not obstruct the flow of combustion and ventilation air.
Maintain minimum of 1" (25) clearance between duct and combustible material.

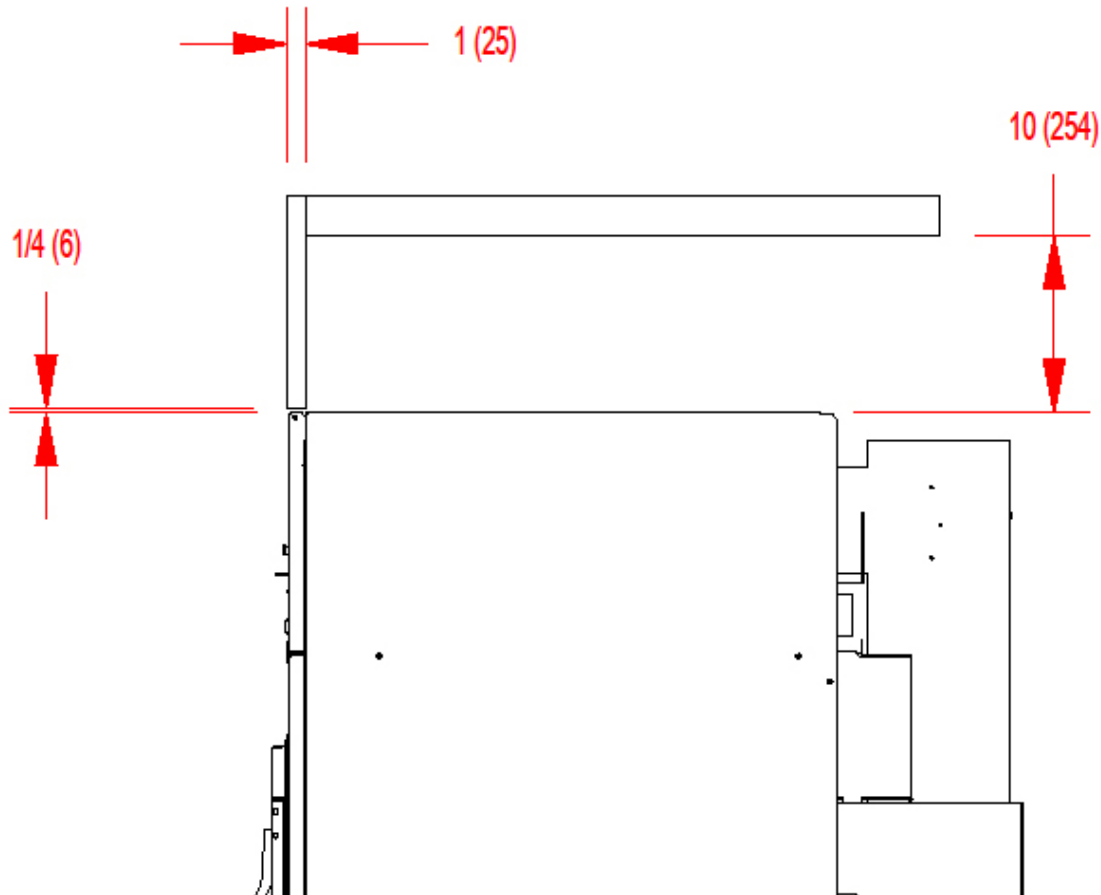

VERTICAL CLEARANCE DIMENSIONS - ALL C Series (30/50/80/120)

MAKE-UP AIR

Adequate make-up air must be supplied to replace air exhausted by dryers on all types of installations. Provide a minimum make-up air opening to the outside for each dryer as follows:

Dryer Model	Make-up Air Volume/Time	Make-up Air Opening Area (minimum)
DC0120NE-10EC2R	1250 or 1450 CFM (35.4 or 41.1 m ³ /minute)	2.25 ft ² (2090 sq. cm.)
DC0120NE-39AB2R	1000 CFM (28.3 m ³ /minute)	2.25 ft ² (2090 sq. cm.)

This is a net requirement of effective area. Screens, grills or louvers, which will restrict the flow of air, must be considered. Consult the supplier to determine the free area equivalent for the grill being used. The source of make-up air should be located sufficiently away from the dryers to allow an even airflow to the air intakes of all dryers. Multiple openings should be provided.

NOTE: The following considerations must be observed for gas dryer installations where dry cleaners are installed. The sources of all make-up air and room ventilation air movement to all dryers must be located away from any dry cleaners. This is necessary so that solvent vapors will not be drawn into the dryer inlet ducts. Dry cleaner solvent vapors will decompose in contact with an open flame such as the gas flame present in clothes dryers. The decomposition products are highly corrosive and will cause damage to the dryer(s), ducts and clothes loads.

ELECTRICAL REQUIREMENTS.

The electrical power requirements necessary to operate the unit satisfactorily are listed on the serial plate located on the back panel of each dryer. The electrical connection should be made to the terminal block in the rear control box assembly on the rear of the unit, using a wire size adequate to handle the amperage and voltage listed on the serial plate, but never smaller than No.12 AWG wire. It is absolutely necessary that the dryer be grounded to a known ground. Individual circuit breakers for each unit are recommended. The wiring diagram is located on the belt guard on the back of the machine.

TRANSIENT VOLTAGE SURGE SUPPRESSORS

Like most electrical equipment your new machine can be damaged or have its life shortened by voltage surges due to lightning strikes which are not covered by factory warranty. Local power distribution problems also can be detrimental to the life of electrical components. We recommend the installation of transient voltage surge suppressors for your new equipment. These devices may be placed at the power supply panel for the complete installation and don't require an individual device for each machine.

These surge protectors help to protect equipment from large spikes and also from small ongoing spikes in the power that occur on a day to day basis. These smaller surges can shorten overall life of electrical components of all types and cause their failure at a later date. Although they can't protect against all events, these protective devices have a good reputation for significantly lengthening the useful life of electronic components.

Electronic Components are helped to have a longer useful life when they are supplied with the clean stable electrical power they like.

GAS REQUIREMENTS.

The complete gas requirements necessary to operate the dryer satisfactorily are listed on the serial plate located on the back panel of the dryer. The inlet gas connection to the unit is 3/4 inch pipe thread. A joint compound resistant to the action of liquefied petroleum gases should be employed in making pipe connections. A 1/8 inch NPT plugged tapping, accessible for test gage connection, must be installed immediately upstream of the gas supply connection to the dryer. A drip tee should be provided in the gas piping entering the unit to catch dirt and other foreign articles. All pipe connections should be checked for leakage with soap solution. Never check with an open flame. For altitudes above 2,000 feet (610m) it is necessary to derate the BTU input. Contact your local distributor for instructions. L.P. gas conversion kits are available for this dryer. Contact your local distributor.

CAUTION: The dryer and its individual shutoff valve must be disconnected from the gas supply piping system during any pressure testing of that system at test pressures in excess of 1/2 psig. The dryer must be isolated from the gas supply piping system by closing its individual manual shutoff valve during any pressure testing of the gas supply piping system at test pressures equal to or less than 1/2 psig.

Burner Set-Up

All gas burner manifolds should be checked for proper gas pressure while burning. Dryer manifold pressure should be set at 3.5 W.C. for Natural Gas while burner operating.

EXHAUST INSTALLATION. (Refer to Figure 2 at the end of section 6.) Exhausting of the dryer(s) should be planned and constructed so that no air restrictions occur. Any restriction due to pipe size or type of installation can cause slow drying time, excessive heat, and lint in the room.

From an operational standpoint, incorrect or inadequate exhausting can cause a cycling of the high limit thermostat which shuts off the main burners and results in inefficient drying.

Individual exhausting of the dryers is recommended. All heat, moisture, and lint should be exhausted outside by attaching a pipe of the proper diameter to the dryer adapter collar and extending it out through an outside wall.

This pipe must be very smooth on the inside, as rough surfaces tend to collect lint which will eventually clog the duct and prevent the dryer from exhausting properly. All elbows must be smooth on the inside. All joints must be made so the exhaust end of one pipe is inside the next one downstream. The addition of an exhaust pipe tends to reduce the amount of air the blower can exhaust. This does not affect the dryer operation if held within practical limits. For the most efficient operation, it is recommended that no more than 20' (6m) of straight 8" diameter pipe be used with two right angle elbows. When more than two elbows are used, 2' (600mm) of straight pipe should be removed for each additional elbow. No more than four right angle elbows should be used to exhaust a dryer.

Maintain minimum 1" (25) clearance between duct and combustible material.

If the exhaust pipe passes through a wall, a metal sleeve of slightly larger diameter should be set in the wall and the exhaust pipe passed through this sleeve. This practice is required by some local codes and is recommended in all cases to protect the wall. This type of installation should have a means provided to prevent rain and high winds from entering the exhaust when the dryer is not in use. A hood with a hinged damper can be used for this purpose. Another method would be to point the outlet end of the pipe downward to prevent entrance of wind and rain. In either case, the outlet should be kept clear, by at least 24" (610), of any objects which would cause an air restriction.

Never install a protective screen over the exhaust outlet. When exhausting a dryer straight up through a roof, the overall length of the duct has the same limits as exhausting through a wall. A rain cap must be placed on top of the exhaust and must be of such a type as to be free from clogging. The type using a cone shaped "roof" over the pipe is suitable for this application.

Exhausting the dryer into a chimney or under a building is not permitted. In either case there is a danger of lint build-up which can be highly combustible.

Installation of several dryers, where a main discharge duct is necessary, will need the following considerations for installation (see Fig. 2). Individual 8" (200mm) ducts from the dryers into the main discharge duct should be at a 45 degree angle in the direction of discharge air flow.

NOTE: Never install the individual 8" ducts at a right angle into the main discharge duct. The individual ducts from the dryers can enter at the sides or bottom of the main discharge duct. Figure 2 indicates the various round main duct diameter to use with the individual dryer ducts. The main duct can be rectangular or round, provided adequate air flow is maintained. For each individual dryer, the total exhausting (main discharge duct plus duct outlet from the dryer) should not exceed the equivalent of 20 feet (6m) and two elbows. The diameter of the main discharge duct at the last dryer must be maintained to exhaust end.

NOTE: A small diameter duct will restrict air flow; a large diameter duct will reduce air velocity – both contributing to lint build up. An inspection door should be provided for periodic clean-out of the main duct.

NOTE: STATIC BACK PRESSURE should be a maximum of 0.3 in. w.c (7.6 mm w.c) at the rear exhaust outlet of the dryer. If multiple dryers are connected to the common duct, ensure the back draft damper is installed properly.

NOTE: The following illustration shows the various round main duct diameters to use with the individual dryer ducts. The main duct can be rectangular or round, provided adequate air flow is maintained. For each individual cylinder the total exhausting (main discharge duct plus duct outlet from the dryer) should not exceed the equivalent of 14 feet and two elbows. The diameter of the main discharge duct at the last dryer must be maintained to exhaust end.

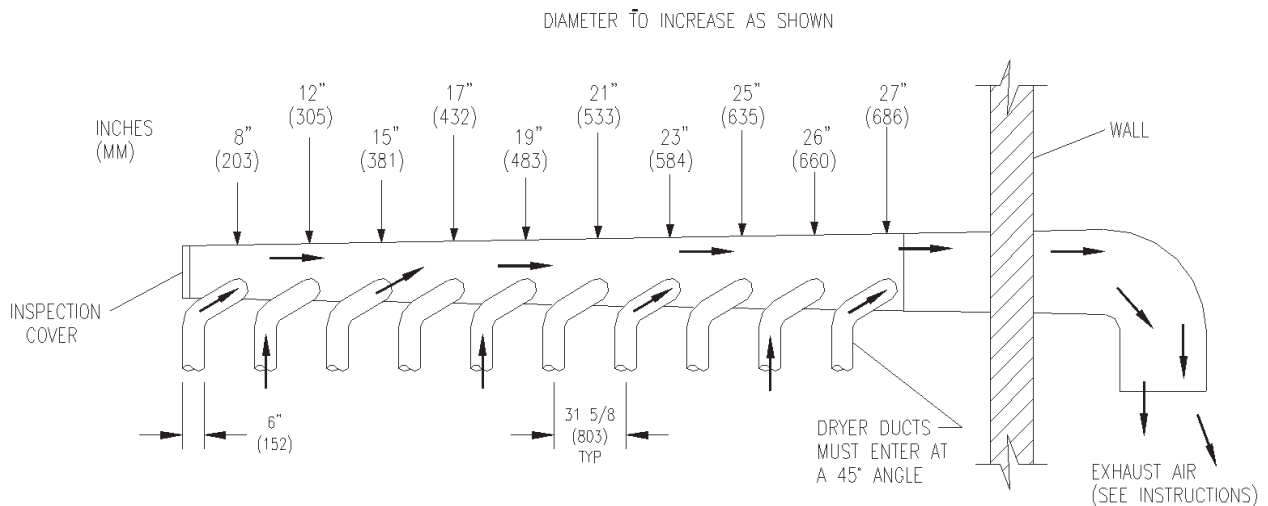

DRYER IGNITION (SOLID STATE IGNITION).

The solid state ignition system lights the main burner gas by spark. The gas is ignited and burns only when the gas-valve relay (in the electronic controller) calls for heat. The procedure for first-time starting of a dryer is as follows:

A. First, review and comply with the "WARNINGS ABOUT USE AND OPERATION" found on the inside front cover of this manual. Be sure the electrical power supply is connected correctly. The white (neutral) wire is to be connected to the N terminal while the black (line) wire to the L1 terminal of the terminal block in the rear control box. The dryer MUST be properly grounded.

B. Make sure all gas supply lines are purged of air. Close the main gas shut-off valve and wait for five minutes before turning the valve back on.

C. Turn on main electrical power switch. The dryer may be started by following the "OPERATING INSTRUCTIONS" found later in this manual.

D. Natural gas and liquefied petroleum gas fired dryers both operate in the same manner. When gas-valve relay contacts are closed (indicating a demand for heat), the solid state ignition control will automatically supply energy to the redundant gas valve. Spark will continue until a flame is detected by the sensing probe, but not longer than 10 seconds. If the gas fails to ignite within 10 seconds, the gas will shut off for 15 seconds. The control will attempt to ignite two more times in a similar manner. If the gas fails to ignite after three tries, the gas valve closes and the system will "lock out". No further attempts at ignition will be performed automatically. It is then necessary to interrupt electrical power to the ignition system before making another attempt to light the burners.

This can be done by opening the dryer door, allowing the dryer to come to a stop for 15 seconds, closing the door, and pushing the "Start" button. The dryer will then repeat the ignition trial cycle.

DRYER SHUTDOWN

To render the dryer inoperative, turn off the main gas shut-off valve and disconnect electrical power to the dryer.

IT IS RECOMMENDED THAT THE INSTALLER TEST THE DRYER FOR OPERATION AND INSTRUCT THE USER BEFORE LEAVING THE INSTALLATION.



Section 2:

Dryer Operating Instructions

OPERATING INSTRUCTIONS

STARTING THE DRYER

1. The display on the dryer control will show the required vend amount when in idle mode. Once the door is opened it will prompt the user to add money. Load clothes into the dryer. Close the door completely.
2. Deposit coins equal to or greater than the displayed vend price. The display on the control will prompt the user to choose a drying temperature.
3. Select the drying temperature by pressing the appropriate button for "high", "med" (medium) or "low". This will turn on the red indicator light showing the selected temperature.
4. Press the "start" button to start dryer. This will turn on the green indicator Light. The drying time purchased is now displayed. The colon begins flashing to indicate that the timer is counting down.

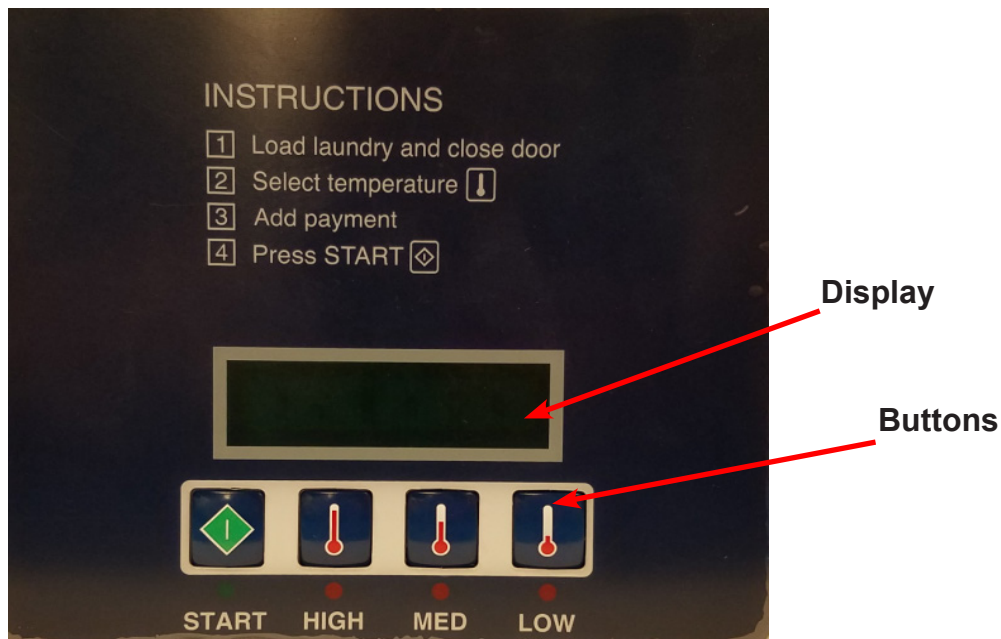

RUNNING THE DRYER

-Opening the door will stop the dryer, but the timer will continue to count down. The dryer will restart, if time has not expired, upon closing the door and pressing the "start" button.

-Selected temperature may be changed at any time (unless Temperature Pricing feature is activated).

-Running time may be extended by depositing coins and pressing the "start" button. Unless time has expired, the controller will accept coins whether or not the original vend price is equaled.

-If time has run out, the dryer must be restarted as if it was at the beginning of drying the load, which requires meeting or exceeding the vend price.

-Clothes should be removed promptly after the cycle is completed to prevent excessive wrinkling.

-Cool-down time (owner programmable) is always part of the cycle time purchased by the customer. For example, if the cool-down time is 2 minutes, then the last 2 minutes of the cycle will have no heat.



Section 3:

Dryer Programing Instructions

DexterLive

The new DexterLive controls were created for you to be able to interface easier with your equipment and create variable pricing cycles to increase your profitability in the same floor space.

First, log into DexterLive, create your location and equipment list and then create your cycle and pricing information by the particular type of washer and dryer at the location. Once the information is saved, download the "AllUser.xml" file to a USB device which will be used to program the machines from the USB port.

Keep it simple or use the marketing features such as temperature pricing, plus cycle or an additional final rinse that the customer can select for a value added wash. Utilize time of day pricing to help move people from heavy use periods to special value times of day or days of the week.

Through the easy to use USB programing so you can download all special pricing and cycles from DexterLive to set up your store quickly and easily.



Accessible

Available anytime, anywhere, on any internet capable device. Once you have set up your free account all of your custom settings and store information are saved making it quick and easy to make future changes.

Simple

View and customize equipment settings to fit your business model. Download your unique user file and quickly transfer it to your equipment via USB.

Profitable

Create exciting promotions to attract new customers. Offer extra prewash, plus cycles, Extra rinse and temperature pricing to drive more revenue in your store.

First Time Creating an Account at Dexter Live

- 1) Log into DexterLive
At the bottom, select "Create your DexterLive account."

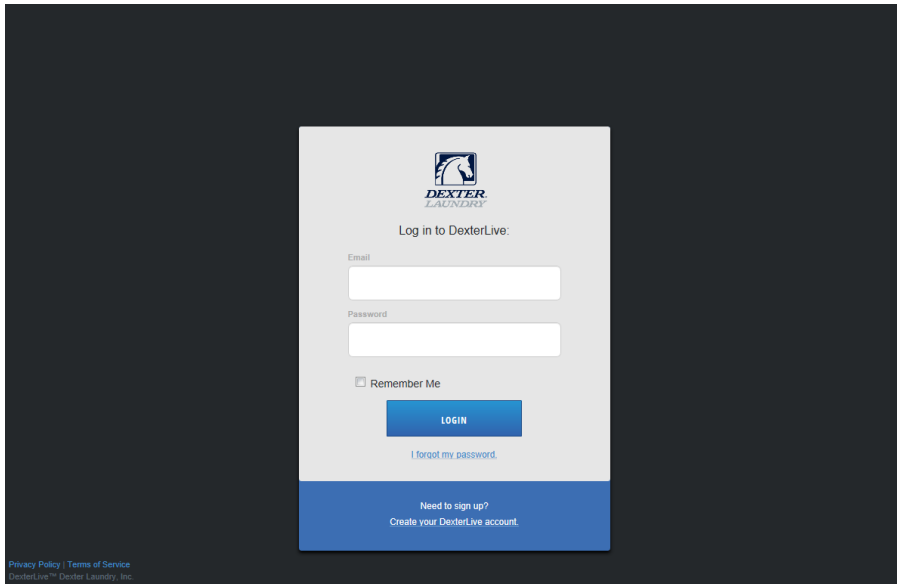

The screenshot shows the DexterLive login interface. At the top is the Dexter Laundry logo. Below it, the text "Log in to DexterLive:" is displayed. There are two input fields for "Email" and "Password". A "Remember Me" checkbox is located below the password field. A blue "LOGIN" button is centered below the fields. A link "I forgot my password." is positioned below the login button. At the bottom of the form, there is a link "Need to sign up? Create your DexterLive account." and a footer with "Privacy Policy | Terms of Service" and "DexterLive™ Dexter Laundry, Inc."

DexterLive gives an owner the ability to manage multiple locations.

- 2) At the "Create a DexterLive Account" screen.
 - A. First time users must create an account.

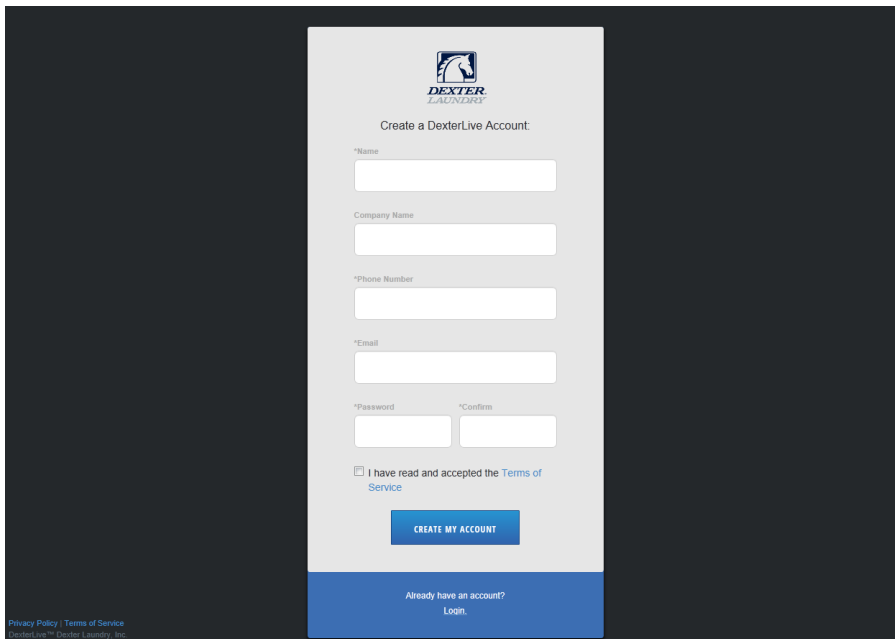

The screenshot shows the "Create a DexterLive Account" form. It features the Dexter Laundry logo at the top. The heading "Create a DexterLive Account:" is followed by several input fields: "*Name", "Company Name", "*Phone Number", "*Email", "*Password", and "*Confirm". A checkbox labeled "I have read and accepted the Terms of Service" is located below the password fields. A blue "CREATE MY ACCOUNT" button is centered at the bottom of the form. Below the button, there is a link "Already have an account? Login." and a footer with "Privacy Policy | Terms of Service" and "DexterLive™ Dexter Laundry, Inc."

An account must be created to use the DexterLive features.

- B.** Fill in the required fields and click on "Create My Account".

The screenshot shows the "Create a DexterLive Account" form. At the top is the Dexter Laundry logo. Below it, the text "Create a DexterLive Account:" is followed by several input fields: "Name" (with an asterisk), "Company Name", "Phone Number" (with an asterisk), "Email" (with an asterisk), "Password" (with an asterisk), and "Confirm" (with an asterisk). A checkbox labeled "I have read and accepted the Terms of Service" is checked. A blue "CREATE MY ACCOUNT" button is at the bottom. In the bottom left corner, there are links for "Privacy Policy" and "Terms of Service" and the text "DexterLive™ Dexter Laundry, Inc."

When creating a new user account make sure to fill in all fields marked with asterisks and check the "Terms of Service" box.

- C.** After selecting to "Create My Account", you will see the log in screen advising you to go to your e-mail and activate your account.

The screenshot shows the "Log in to DexterLive:" screen. It features the Dexter Laundry logo, the text "Log in to DexterLive:", and input fields for "Email" and "Password". There is a "Remember Me" checkbox and a blue "LOGIN" button. Below the button is a link that says "I forgot my password." At the bottom, there is a blue box with the text "Need to sign up? Create your DexterLive account." A green callout box on the right side of the form contains the text: "A message with a confirmation link has been sent to your email address. Please open the link to activate your account." In the bottom left corner, there are links for "Privacy Policy" and "Terms of Service" and the text "DexterLive™ Dexter Laundry, Inc."

After creating your account you will need to use the e-mail link to gain first access. The account will not be active until you confirm your account.

- 3) Open the e-mail sent from Dexterlive and select "CONFIRM MY ACCOUNT".

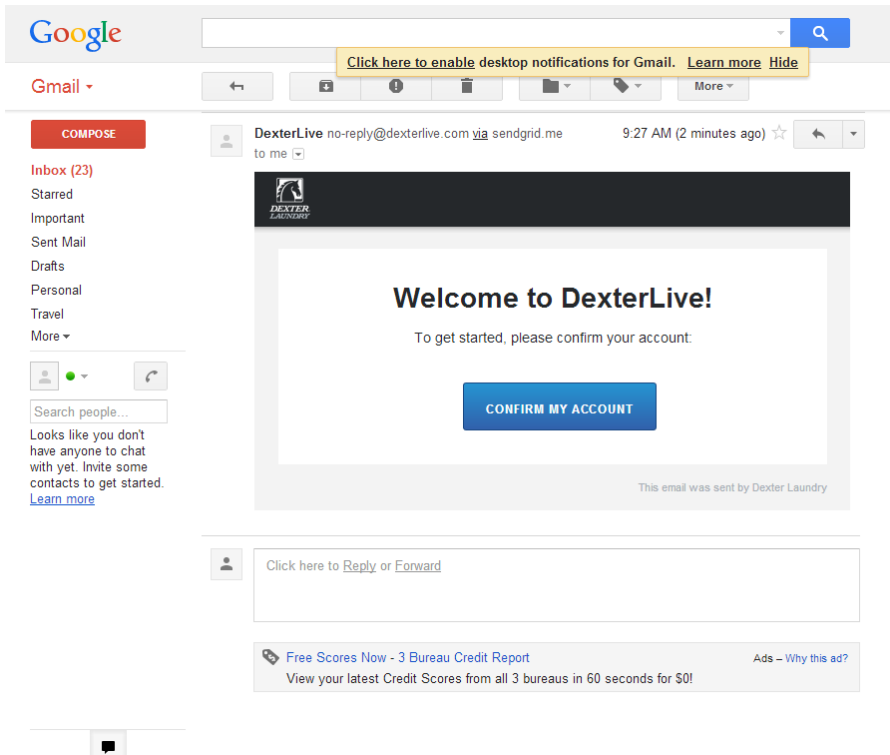

Selecting the "Confirm My Account" hyperlink will take you back to the DexterLive log in page.

- 4) At the "Log into DexterLive" screen, enter your e-mail/user name and password to access DexterLive.

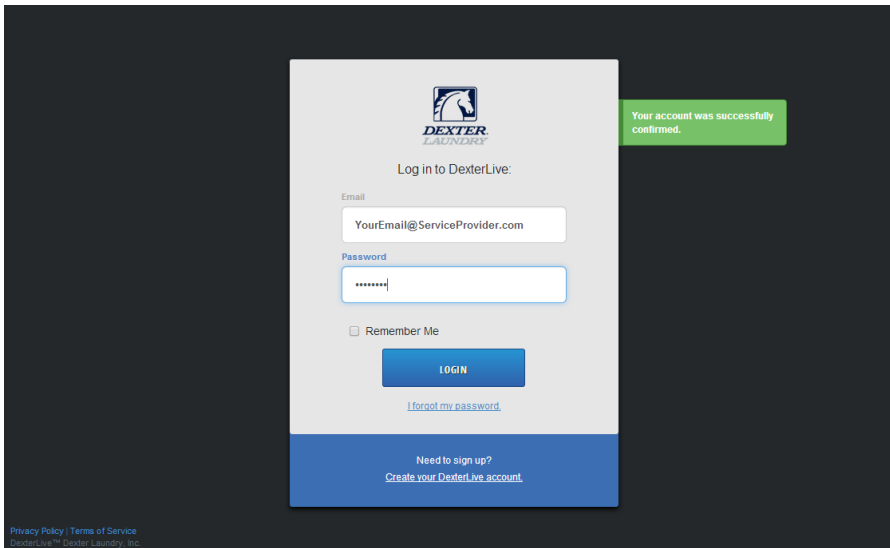

Welcome to DexterLive. Proceed to the step to create your location information.

Programming

- 5) To configure your settings with DexterLive.com:
 - A. Add or select a location to program.

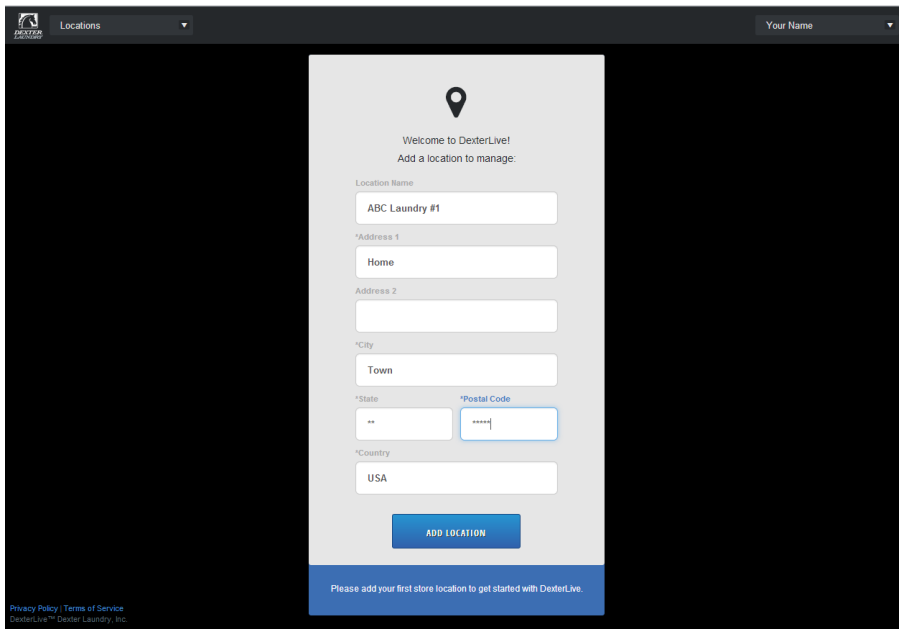

DexterLive gives an owner the ability to manage multiple locations and machines.

- B. On the left side of the screen, select the "Programming" tab.

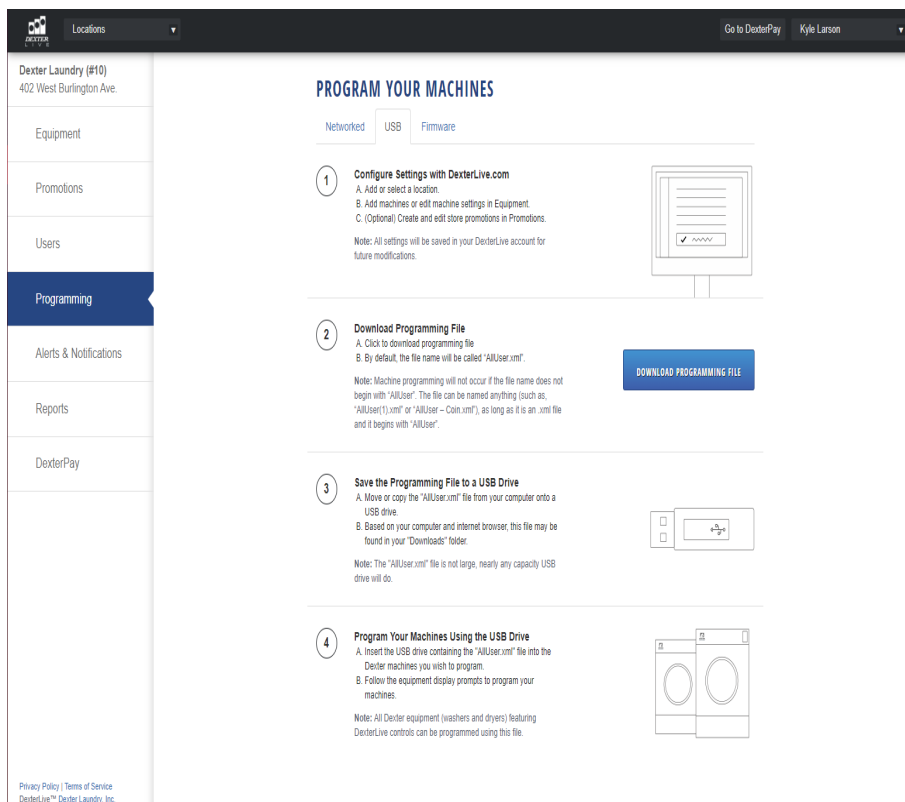

Follow instructions in the programming tab.

C. Edit the "General Settings" (Equipment Tab).

The screenshot shows the 'EQUIPMENT' settings page for Dexter Laundry (#10). The 'General Settings' tab is selected, and the 'General Settings - All Machine Types' section is visible. The settings are organized into three categories: Washers and Dryers, Washers Only, and Dryers Only. The 'Washers and Dryers' section includes: Machine Display Language (English), Display Currency (United States Dollar - \$), Display Decimal Point (On), Sounds (On), and Password (0000). The 'Washers Only' section includes: View Non-Critical Errors (Off). The 'Dryers Only' section includes: Display Temperature Scale (°F), Display Time (Minutes only displayed), and Central Pay (Off). A blue 'SAVE SETTINGS' button is located at the bottom center of the settings area, with a 'Cancel' link below it.

Adjust setting and offset time to match your location. (Time is set for Central Standard Time)

D. Next select the "+Add Equipment" (Equipment Tab), located in the upper right hand corner.

The screenshot shows the 'EQUIPMENT' page with an 'ADD MACHINE' modal window open. The modal has a title bar with 'ADD MACHINE' and a close button. It contains four input fields: 'My Machine Name', 'Serial Number', 'Machine Type' (a dropdown menu), and 'DexterLive ID' (with a placeholder 'XXXX-XX-XX-XX-XX'). Below the fields is a blue 'SAVE & CONTINUE' button. At the bottom of the modal, it says 'Done adding machines'. The background shows the 'EQUIPMENT' page with a '+ Add Equipment' button in the top right corner and a table with columns 'MACHINE ID' and 'SERIAL NUMBER' containing the values 'T-1450' and 'W11111111'.

Name of the machine. (Example: Dryer 1) Enter serial number and machine type then select "Save and Continue."

- E.** When all of the equipment has been added, select “Edit” on the machine type you wish to modify, and then select “Pricing”. (Equipment Tab and Machine Settings Tab)

The screenshot shows the 'Pricing' tab for a T-80 SINGLE DRYER. The settings are as follows:

Section	Setting	Value
Pricing	Base Vend Price	2.50
	Extend Vend Price	0.25
Temperature Adders	Medium Temp Adder	FREE
	High Temp Adder	FREE
Promotional Pricing	Base Vend Price (A)	2.50
	Extend Vend Price (A)	0.25
	Base Vend Price (C)	FREE
	Extend Vend Price (C)	0.25
Coin Values	Left Coin Value	0.25
	Right Coin Value	0.25

Buttons: SAVE FOR ALL T-80S, Cancel

Program the price of the machine and the extra pricing adders.

- F.** Cycle changes can be made by selecting the “Cycles” tab.

The screenshot shows the 'Cycles' tab for a T-80 SINGLE DRYER. The settings are as follows:

Section	Setting	Value
Cycle Settings	Cycle Time	35 min
	Free Vend Time	35 min
	Extend Vend Time	7 min
Temperature Settings	High Temperature	175°F
	High Cool Down Time	5 min
	Medium Temperature	150°F
Options	Default Dry Temp	Medium
	End-of-Cycle Extend Dry	Yes

Buttons: SAVE FOR ALL T-80S, Cancel

Adjust cycle programming set the length of time and extracts speed as needed.

- G. If desired, you may create and edit optional store promotions from the "Promotions" Tab.

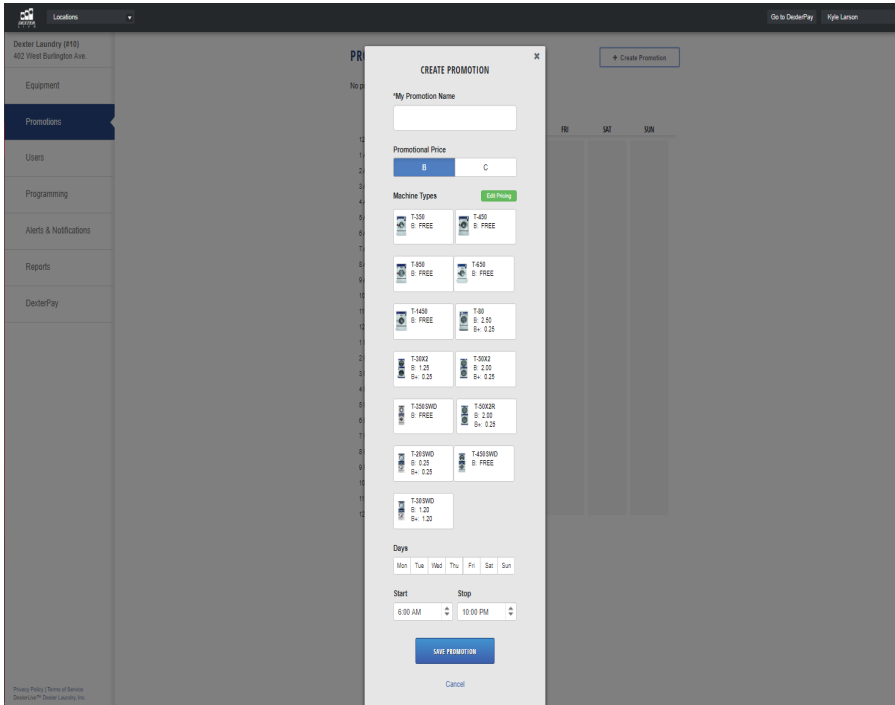

Select "Save Promotion" once your changes have been made.

- 6) Create and download the Programming File.
 A. Once all preferred prices, cycles and promotions have been modified and saved, select **"DOWNLOAD PROGRAMMING FILE"**.

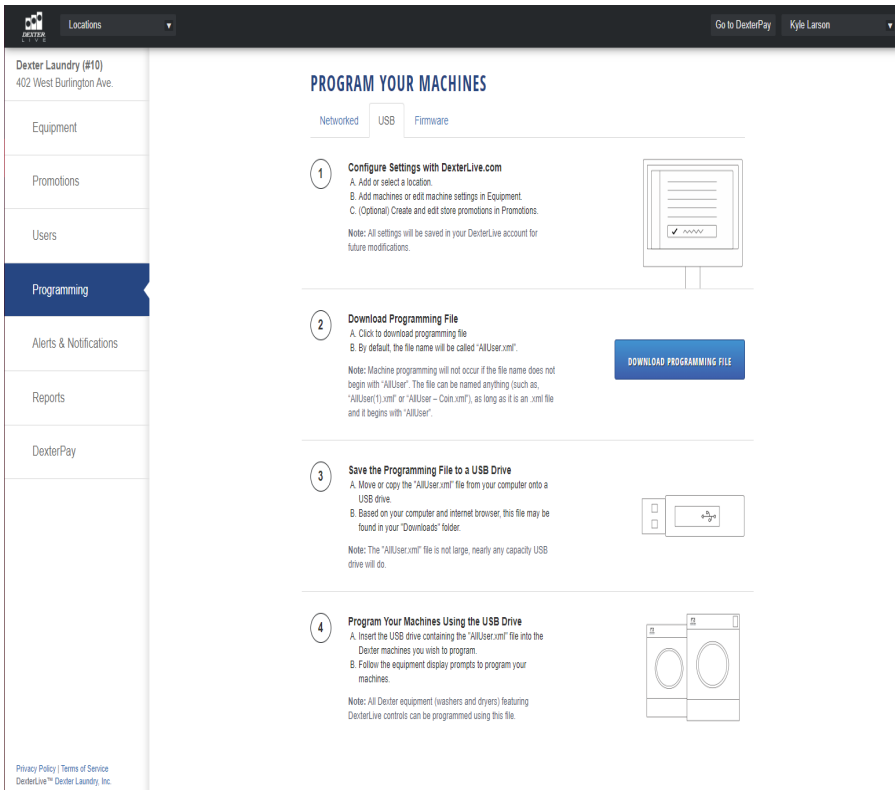

- B.** Based on your internet browser the file needs to be saved as "AllUser.xml". Depending on your Internet browser you may need to retrieve the file from your "Downloads" folder, which is located under "Computer".

Note: The newly created programming file may have changed from the proper "AllUser.xml" Machine programming will not occur using a different file name than "AllUser.xml". Any extra extension names will require the file to be renamed back to "AllUser.xml" for the machine to recognize the file.

7) To save the Programming File to a USB Drive:

- A.** Move or Copy the "AllUser.xml" file from your computer onto a USB drive.
- B.** Based on your computer and internet browser, this file may be found in your "Downloads" folder, which is located under the "Computer" area.

Note: The "AllUser.xml" file size is small, nearly any capacity USB drive will do.

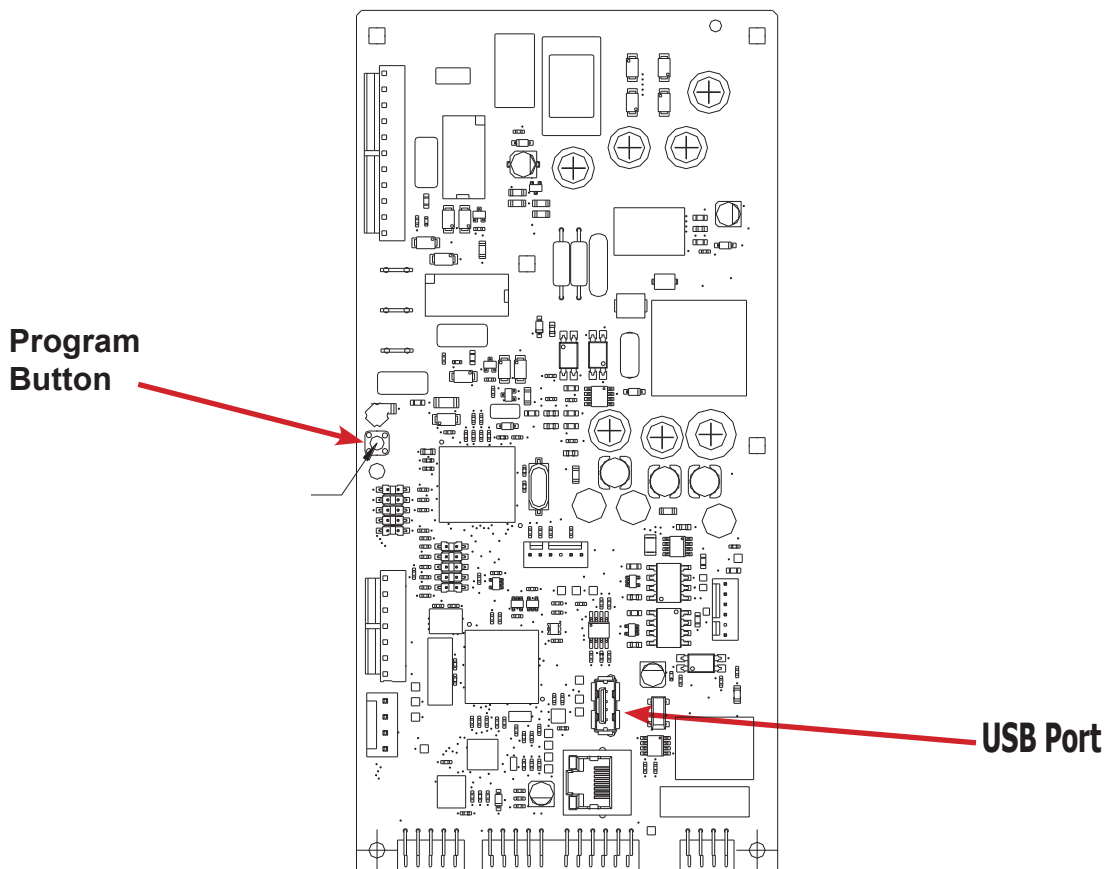

8) Program Your Machines Using the USB Drive

CAUTION!!! Be sure that any loose keys or other items that are connected to the USB device are removed from the USB stick to prevent any possible metal contact with the control board.

- A.** Insert the USB drive containing the "AllUser.xml" file into the Dexter machines you wish to program. The control will scroll "....." while identifying the program on the USB. Once identified, the display will scroll "INSTALL USER FILE FROM USB". At this prompt press the green start button on the front panel.

-
- B.** The machine will scroll "TO INSTALL – PRESS START". At this prompt, press the green "Start" again.

 - C.** Once the program is uploaded successfully the control will scroll "DONE REMOVE USB". The USB drive can be safely removed at this point.

Note: All Dexter equipment (washers and dryers) featuring DexterLive controls can be programmed using this file once the equipment has been configured.

PROGRAMMING THE DRYER CONTROL

The dryer control can be programmed to prompt the user for alternate vend prices, change dryer cycle times, temperatures and many other options. This can be accomplished in two ways:

1. Manual programming utilizing the "Start", "High", "Medium" and "Low" buttons for the bottom dryer.
2. USB download of a customizable User File. For instructions on using the USB download feature, please contact your local Dexter distributor or visit DexterLive.com.

MANUAL PROGRAMMING:

The dryer must be in idle mode for the manual programming menus to be accessed. Idle mode is when the dryer is not actively running a drying cycle and the vend price is displayed on the screen (for both upper and lower dryers).

To enter the manual programming mode, the control tray on the dryer must be unlocked and pulled out to reveal the programming button. The programming button is then pressed for 1 second. The control should display "DRYER PROGRAMMING".

See the figure below for the location of the programming button on the control tray.

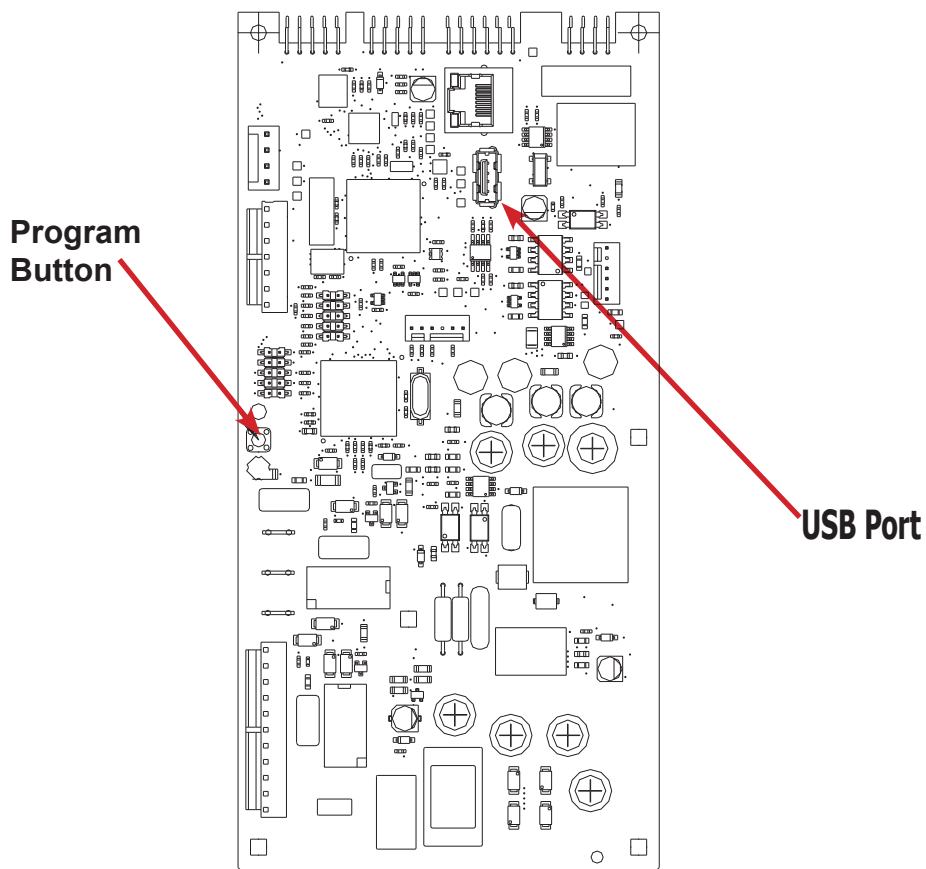

When manual programming mode is entered, the "Start", "High", "Medium" and "Low" buttons for the lower dryer perform alternate functions. Please note that the changes made using the lower dryer buttons affect both upper and lower dryers.

Button Name	Alternate Function in Programming Mode
Start	Becomes the action to accept the displayed option or the "Enter" key
High	Becomes the action to move UP through displayed options (Press & hold for accelerated scrolling)
Medium	Becomes the action to move DOWN through displayed options (Press & hold for accelerated scrolling)
Low	Becomes the action to move back a step (1 press) or EXIT from programming mode (press for 3 seconds)

These alternate functions allow the user to move through a menu of options to choose various programmable settings. The figure below shows the top level menu. Choosing an option from the top level menu will then display the next level of options (the sub menu).

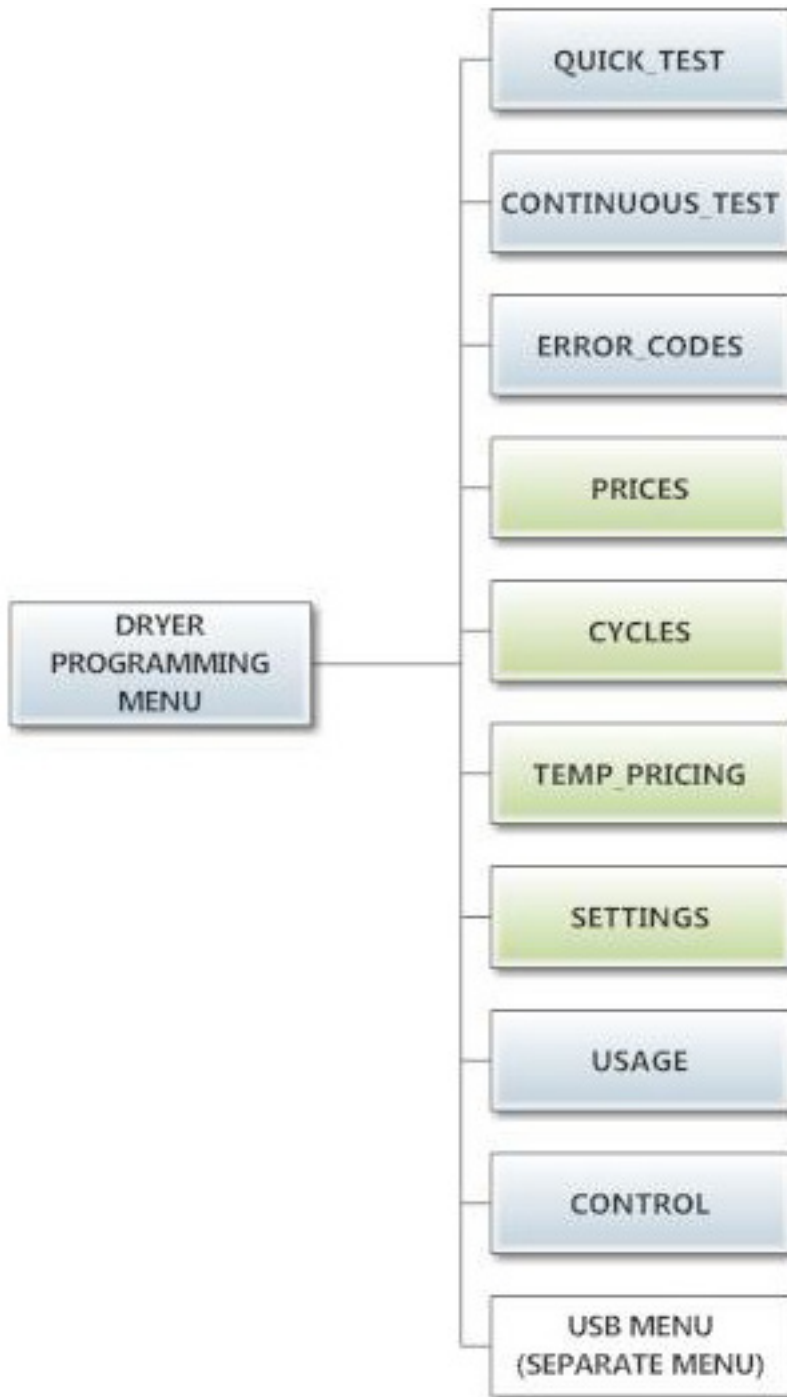

Quick Test Option:

When the Quick Test Option is chosen, the dryer will begin a shortened dry cycle without the displayed vend price being met. The purpose of this shortened cycle is to test all major components for proper operation.

Error Codes should all function normally during this test. The display will show customer prompts in a similar way to a normal dry cycle.

Continuous Test Option:

Similar to the Quick Test, when the Continuous Test Option is chosen, the dryer will begin a dry cycle without the displayed vend price being met. However, in this case, it will be a continuously-running cycle. It will not time out after any designated amount of time.

CAUTION: This option is meant for factory use only. Do not operate the dryer with this cycle active without factory authorization.

Error Code Historical Log:

The last five occurring error codes will be stored in the control with a time and date stamp. The purpose of this option is only to observe the history of these code occurrences (no changes can be made).

The time is based off the Real Time Clock, but potentially shifted by the user's manual programming changes (Shift Hours option) and/or network time override. As additional error codes occur, the oldest of the five logged codes is cleared from memory.

Prices Option:

This option allows the user to set values for coin acceptor inputs, vend price & time and extend dry price & time. It also allows the user to return the values to factory defaults. After changing prices using the "Up" or "Down" buttons, the "Enter" button must be pressed again for the control to store the changes that have been made. Note that, in general, time values are set in 1 minute increments. This can be changed to 30 second increments, by changing the "Display Time" to "MIN+SEC" (refer to the "Settings" section").

1. "RIGHT COIN" and "LEFT COIN" are the two possible inputs from coin acceptors.
2. "PRICE SET VEND" is the actual Base Vend Price (or Vend Price A) that is shown on the control display. The value can be increased or reduced even down to "0". In this case, the displays will prompt "FREE" and the cycle will start as soon as the "Start" button is pressed (without any vend price being met).
3. "TIME SET VEND" is the cycle time that the customer has available once they've met the Base Vend Price.
4. "FREE SET TIME" is the cycle time that the customer has available if the Base Vend Price is set to "FREE".
5. "EXTEND DRY" sets the price and time for additional drying time that becomes available after the customer has already met the Base Vend Price.

To reset either the coin acceptor inputs or the vend price to factory default, press "Enter" when the "DEFAULT" prompt is shown. Press "Enter" again when the "RESET" prompt is shown to confirm the action.

Example- A store owner has programmed the control for the following values:

Base Vend Price	\$1.00
Base Vend Time	30 minutes
Extend Dry Price	\$.25
Extend Dry Time	8 minutes

In this case, the customer adds 4 quarters to satisfy the \$1.00 Vend Price. The display shows 30 minutes of drying time. At this point, if an additional quarter is added, the customer display shows an additional 8 minutes of drying time (38 minutes total) as per the Extend Dry Price & Time.

The customer starts the drying cycle and at 25 minutes into the cycle (13 minutes displayed), they add an additional quarter. The controller adds 8 minutes to the displayed time again (21 minutes total) as per the Extend Dry Price & Time.

"AFTER CYCLE" allows the user to choose whether a customer is allowed to add "EXTEND DRY" time for up to 30 seconds after the dryer door is opened after a completed cycle.

Prices Option:

This option allows the user to set values for coin acceptor inputs, vend price & time and extend dry price & time. It also allows the user to return the values to factory defaults. After changing prices using the "Up" or "Down" buttons, the "Enter" button must be pressed again for the control to store the changes that have been made. Note that, in general, time values are set in 1 minute increments. This can be changed to 30 second increments, by changing the "Display Time" to "MIN+SEC" (refer to the "Settings" section).

1. "RIGHT COIN" and "LEFT COIN" are the two possible inputs from coin acceptors.
2. "PRICE SET VEND" is the actual Base Vend Price (or Vend Price A) that is shown on the control display. The value can be increased or reduced even down to "0". In this case, the displays will prompt "FREE" and the cycle will start as soon as the "Start" button is pressed (without any vend price being met).
3. "TIME SET VEND" is the cycle time that the customer has available once they've met the Base Vend Price.
4. "FREE SET TIME" is the cycle time that the customer has available if the Base Vend Price is set to "FREE".
5. "EXTEND DRY" sets the price and time for additional drying time that becomes available after the customer has already met the Base Vend Price.

To reset either the coin acceptor inputs or the vend price to factory default, press "Enter" when the "DEFAULT" prompt is shown. Press "Enter" again when the "RESET" prompt is shown to confirm the action.
Example- A store owner has programmed the control for the following values:

Base Vend Price	\$1.00
Base Vend Time	30 minutes
Extend Dry Price	\$.25
Extend Dry Price	8 minutes

In this case, the customer adds 4 quarters to satisfy the \$1.00 Vend Price. The display shows 30 minutes of drying time. At this point, if an additional quarter is added, the customer display shows an additional 8 minutes of drying time (38 minutes total) as per the Extend Dry Price & Time.

The customer starts the drying cycle and at 25 minutes into the cycle (13 minutes displayed), they add an additional quarter. The controller adds 8 minutes to the displayed time again (21 minutes total) as per the Extend Dry Price & Time.

"AFTER CYCLE" allows the user to choose whether a customer is allowed to add "EXTEND DRY" time for up to 30 seconds after the dryer door is opened after a completed cycle.

The figure below shows the sub menu options for Prices:

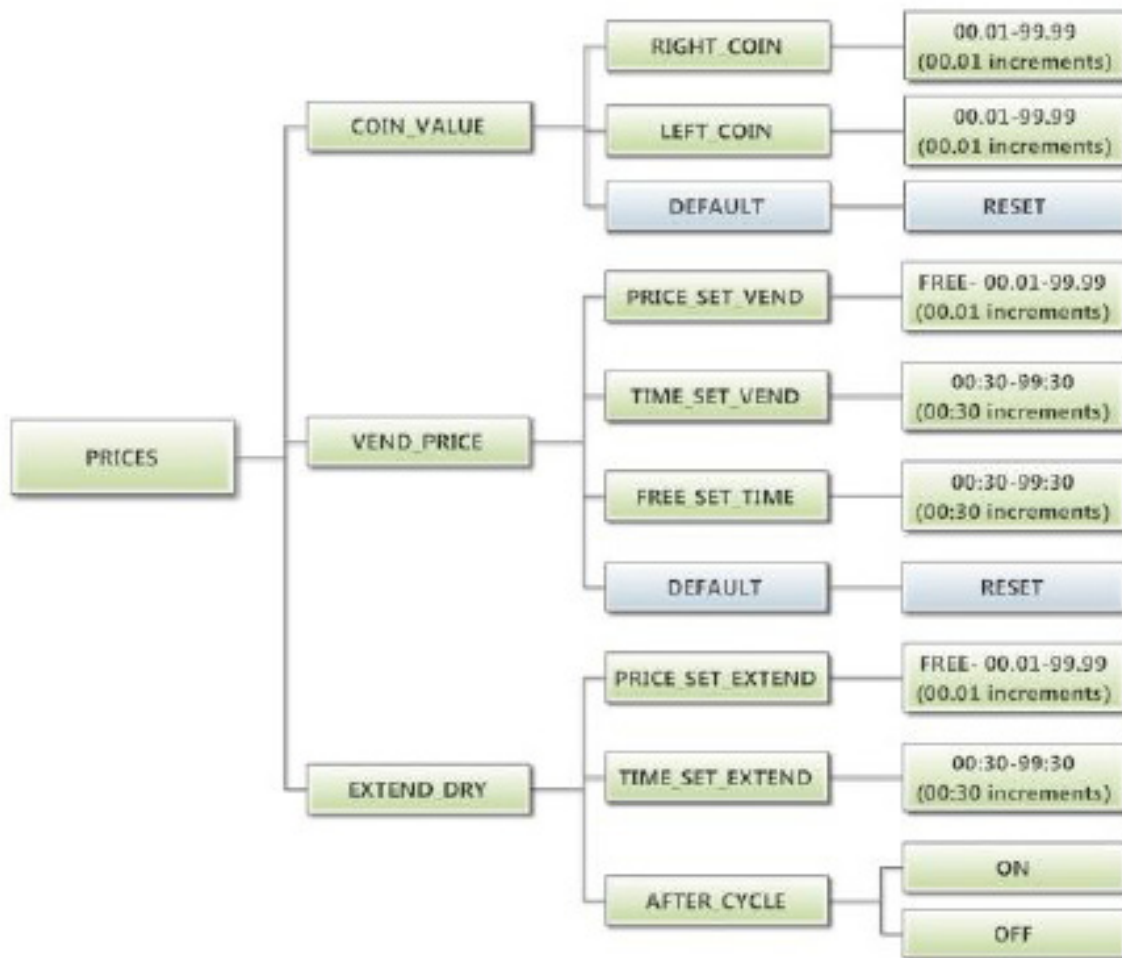

Cycles Option:

This option allows the user to set temperature and cooldown information for the drying cycle. It also allows the user to return the values to factory defaults.

1. "TEMP SETTINGS" allows the user to make adjustments, within a designated range, to the cycling temperature for each of the "Low", "Medium" and "High" customer choices.
2. In addition, on the "Low" setting, the user can reduce the cycling temperature below 110 degrees F. In this case, when the customer chooses the "Low" setting, the dryer will not turn on the gas valve. When checked, the displayed temperature will read "NO HEAT".
3. "COOLDOWN" allows the user to change the designated time at the end of a cycle where the gas valve relay is turned off. On "High" and "Medium" temperature settings, the designated time cannot be reduced to less than 2 minutes.
4. "DEFAULT TEMP" allows the user to choose which general temperature setting, "High", "Medium" or "Low", the control will default to at the beginning of each cycle if the customer does not make a choice.
5. "ANTI WRINKLE" is a feature that periodically rotates the dryers after a cycle is complete. If the door was closed at the end of the cycle, and is left closed for 5 minutes, the enunciator will sound and the display begins scrolling "ANTI WRINKLE". 5 seconds later, the dryer motor will turn on for 60 seconds and then turn off. The gas valves will not be turned on. The "ANTI WRINKLE" message will continue throughout the time that the motor is turned on. The user can choose to enable or disable this feature.

To reset all values in the Cycles option to factory default, press "Enter" when the "DEFAULT" prompt is shown. Press "Enter" again when the "RESET" prompt is shown to confirm the action.

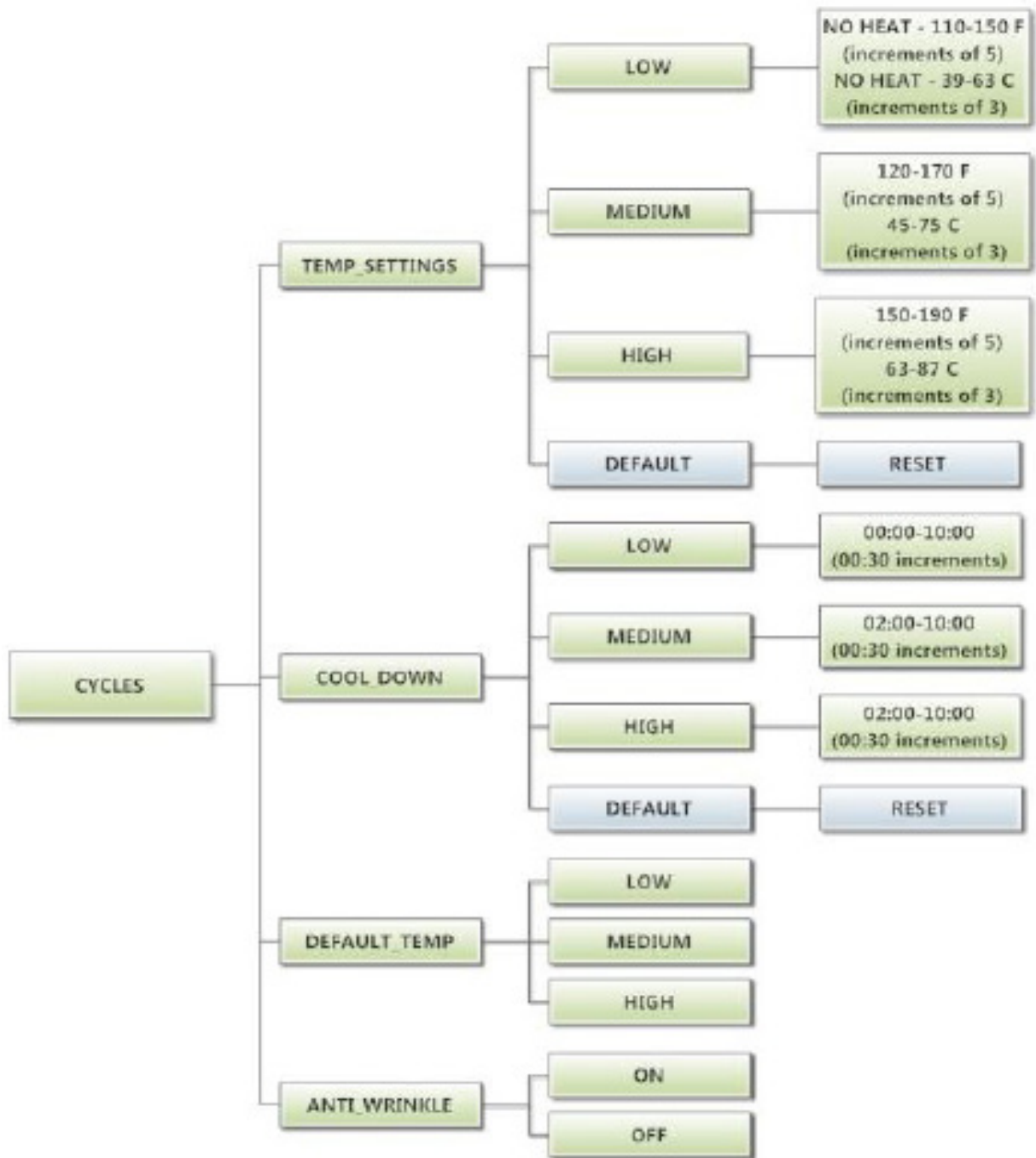

Temperature Pricing Option:

This option allows the user to require additional vend amounts be added based on the drying temperature chosen by the customer. This pricing adder is effective only for the Base Vend Price (it does not affect the Extend Dry Price). It allows a pricing adder separate for "Medium" and "Hot" temperature settings.

Example- A store owner has programmed the control for the following:

Vend Price	\$1.00
Vend Time	30 minutes
Extend Dry Price	8 minutes
Medium Adder	\$.25
Hot Adder	\$.50

In this case, the Vend Price is displayed as:

\$1.00 if Low Temperature is chosen

\$1.25 if Medium Temperature is chosen

\$1.50 if Hot Temperature is chosen

When Temperature Pricing Adders are in place (user has chosen a higher value than \$0.00), if the customer attempts to change their temperature selection from a lower temperature to a higher one during a drying cycle, there will be no change in the temperature selection. The higher temperature buttons are disabled until the drying cycle is complete and a new Vend Price is required.

The figure below shows the sub menu options for Temperature Pricing:

The figure below shows the sub menu options for Temperature Pricing:



Settings Options:

The Settings options allow for the user to make various programming changes to change how the control operation affects the customer. See below for detailed information on each next level option.

1. "Decimal Point": If the user programs the Decimal Point to "OFF", control display will not show a decimal point on any vend price values. The factory default is "ON".
2. "Display Time": If the user programs this value to "MIN", then minutes only will be shown for the cycle time. If it is programmed to "MIN+SEC", then minutes and seconds will be shown. This also allows other programming changes, involving time, to be made in either minute increments or minutes & seconds increments, as desired.
3. "Temp Scale": If the user programs this value to "F", then the temperatures will be displayed in Fahrenheit units. If it is programmed to "C", then the temperature will be in Celsius units.
4. "Sounds": If the user programs the Sounds to "OFF", the control will not sound the enunciator at the end of a dry cycle. The factory default is "ON".
5. "Password": If the user programs the password to any value other than 0000, the control will prompt the user to enter a password (the programmed value) before manual programming can be accessed. The factory default is "0000" (no password).
 - a. Note that if the user forgets the Password, it can be reset to factory default (no password), by performing a hard reset on the control. Please refer to the appropriate section of this manual to understand how to perform a hard reset.
 - b. The individual digits of the Password can be set by using the "Up" or "Down" buttons to change the number that is flashing. Once the desired number is chosen for a single digit, press the "Enter" button to move to the next one. Once all four desired digits are chosen, the "Enter" button must be held down for 3 seconds to confirm that the complete password should be set.
6. "Central Pay": If the user programs this value to "ON", the left and right coin inputs become upper and lower dryer coin inputs.

Central Pay "OFF"	Central Pay "ON"
Left Coin Input	Upper Dryer Input
Right Coin Input	Lower Dryer Input

A system can then be installed that will register coin inputs per individual dryer remotely from a Central Pay kiosk. The left and right coin prices must be appropriately programmed. When this option is enabled, the controller will only display customer prompts for a designated dryer. This designated dryer is determined when coins are inserted at the Central Pay kiosk.

7. "Language": The control uses English for the default language of the customer prompts. Alternatively, the user can choose Spanish or French for the customer display prompts. However, all other prompts, such as Manual Programming, USB Programming and any Error Codes will still display in English.

-
8. "Shift Hours": This feature allows the user to shift the time used by the control from the time kept internally by the control. The control uses a Real Time Clock (RTC) to internally track the time and date. The RTC continues operation even if the control loses external power. The RTC is set for Central Standard Time and no daylight savings. Because the machine may be located in another time zone, the user can choose to create an alternate time & date that tracks in parallel to the RTC. When this alternate time is chosen, or shifted from the RTC, the alternate time will be used to, for example, track error code occurrences and set time-of-day pricing changes.
 - a. The hours in "SHIFT HOURS" can be set by using the "Up" or "Down" buttons to change the number that is flashing. Once the desired hour shift is chosen, press the "Enter" button to move to the minutes. Once the hours and minute shift are both chosen, the "Enter" button must be held down for 3 seconds to confirm that the complete shifted time is set.
 9. "Time": The control uses a Real Time Clock (RTC) to internally track the time and date. The RTC continues operation even if the control loses external power. The RTC is set for Central Standard Time and no daylight savings. However, if a problem occurs and the RTC time is not accurate, it can be reset to the current time using this option.
 - a. The hours in "TIME" can be set by using the "Up" or "Down" buttons to change the number that is flashing. Once the desired hour is chosen, press the "Enter" button to move to the minutes. Once the hours and minute are both chosen, the "Enter" button must be held down for 3 seconds to confirm that RTC is meant to be reset to the complete entry.
 10. "Date": Similar to "Time", if a problem occurs and the RTC date is not accurate, it can be reset to the current date using this option.
 - a. The day of the month in "DATE" can be set by using the "Up" or "Down" buttons to change the number that is flashing. Once the desired day of the month is chosen, press the "Enter" button to move to the month of the year. Once the desired month of the year is chosen, press the "Enter" button to move to the year. Once the day, month and year are all chosen, the "Enter" button must be held down for 3 seconds to confirm that RTC is meant to be reset to the complete entry. To reset all values in the Settings options to factory default, press "Enter" when the "DEFAULT" prompt is shown. Press "Enter" again when the "RESET" prompt is shown to confirm the action.

The figure below shows the sub menu options for Settings:

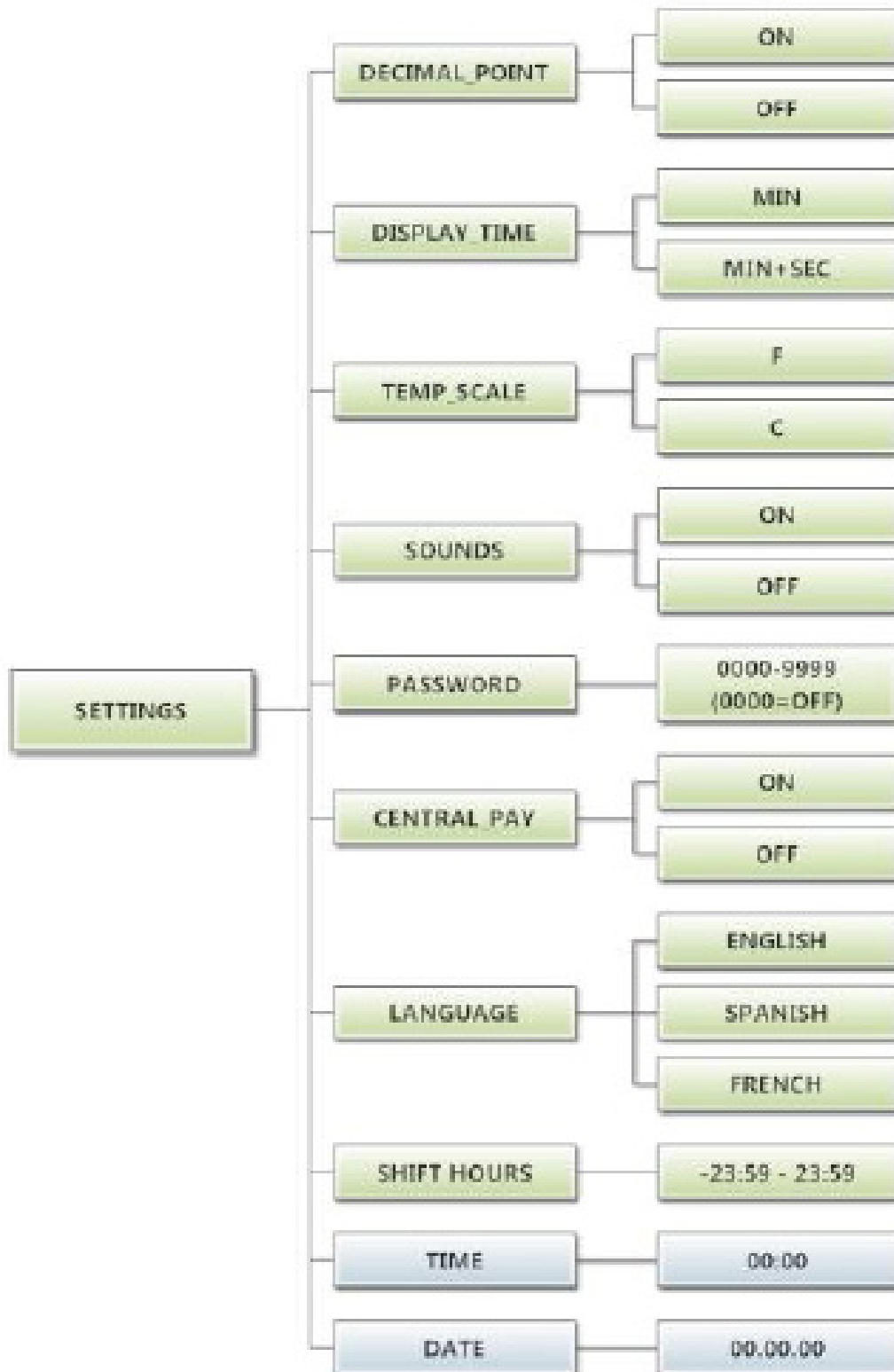

Usage Menu:

The Usage menu allows for the user to track data about machine usage. See below for detailed information on each sub menu option.

1. "Coin Audit": The coin audit field shows the accumulation of coin pulses that were sent to the control over each of the left and right coin inputs. Note that this is a count of coin pulses, not an accumulated report of vend value.
 - a. The user can also return the coin audit amounts to the factory default setting (zero). To reset all coin audit values, press "Enter" when the "DEFAULT" prompt is shown. Press "Enter" again when the "RESET" prompt is shown to confirm the action.

2. "Motor Hours": The motor hours field shows the accumulated hours of operation for both the upper and lower motors independently. In many cases, it will match the cycle hours of the machine. However, separate fields are provided in the event that a motor is replaced on a machine. The user can set the motor hours to a designated number. For example, if it is necessary to replace the control on a machine, the new control could be programmed to show the motor hours that were recorded by the previously installed control. The individual digits of the hours count can be set by using the "Up" or "Down" buttons to change the number that is flashing. Once the desired digit of the hours is chosen, press the "Enter" button to move to the next digit. Once the complete hours are chosen, the "Enter" button must be held down for 3 seconds to confirm the action.
 - a. The user can also return the motor hours to the factory default setting (zero). To reset the motor hours, press "Enter" when the "DEFAULT" prompt is shown. Press "Enter" again when the "RESET" prompt is shown to confirm the action.

3. "Cycle Hours": The cycle hours field shows the accumulated hours of operation for both the upper and lower dryer dryers independently. In many cases, it will match the motor hours of the machine. However, separate fields are provided in the event that a motor is replaced on a machine. See the Motor Hours description for more information.

The figure below shows the sub menu options for Usage:



Control Menu:

The Control menu allows for the user to observe important technical information for the control. No changes can be made at this menu. See below for detailed information on each sub menu.

1. "Serial Number": This is the control serial number.
2. "MAC Address": The MAC Address is a unique identifier designated to the control by the manufacturer. It allows the control to be recognized by network routers.
3. "IP Address": The IP Address is the identifier given to the control by a network system.
4. "M Firmware": The M Firmware is the Main Firmware currently loaded onto the control.
5. "C Firmware": The C Firmware is the Communications Firmware currently loaded onto the control.

The figure below shows the sub menu options for Control:

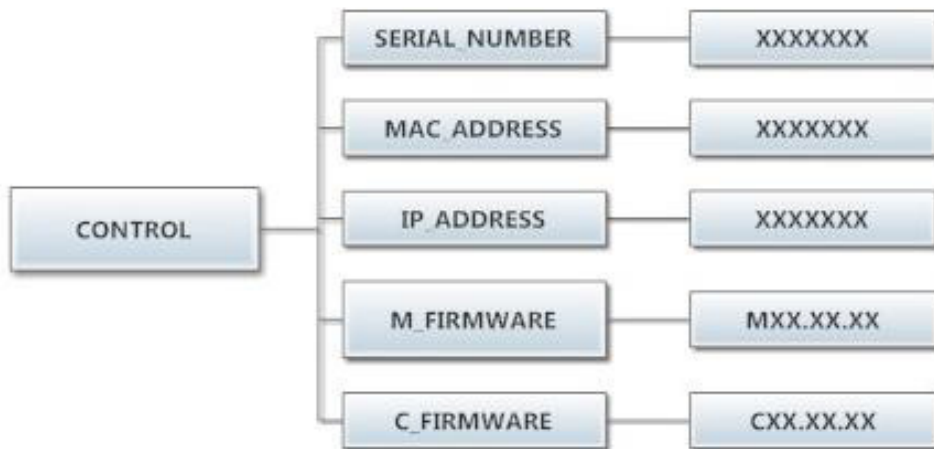



Section 4:

Dryer Service Procedures

Trouble Shooting and Schematics

Service Procedures

Removing Top for Low Clearance Entrances

1. Remove front upper service panel by removing the four Phillips head screws.



Phillips head screws

Phillips head screws

2. Remove top cover by removing the sixteen 5/16 screws holding the top cover, five on each side and the center six holding the cover to the burner housing.
3. Top side removal, remove the two 5/16 screws holding each side.

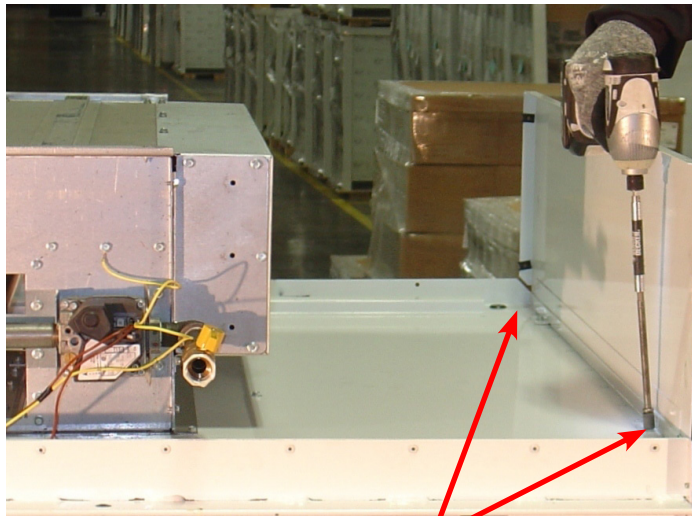

5/16 head screws

4. Remove Burner Assembly.
 - A. Disconnect wires from gas valve, brown and yellow wires and remove yellow ground wire bolted to the burner housing. Remove brown and orange wires from high limit thermostat. Remove igniter high voltage lead and the black heat senscs probe wire.

Removing Top for Low Clearance Entrances Continued.

- B. Remove the three 5/16 screws holding left side of burner.

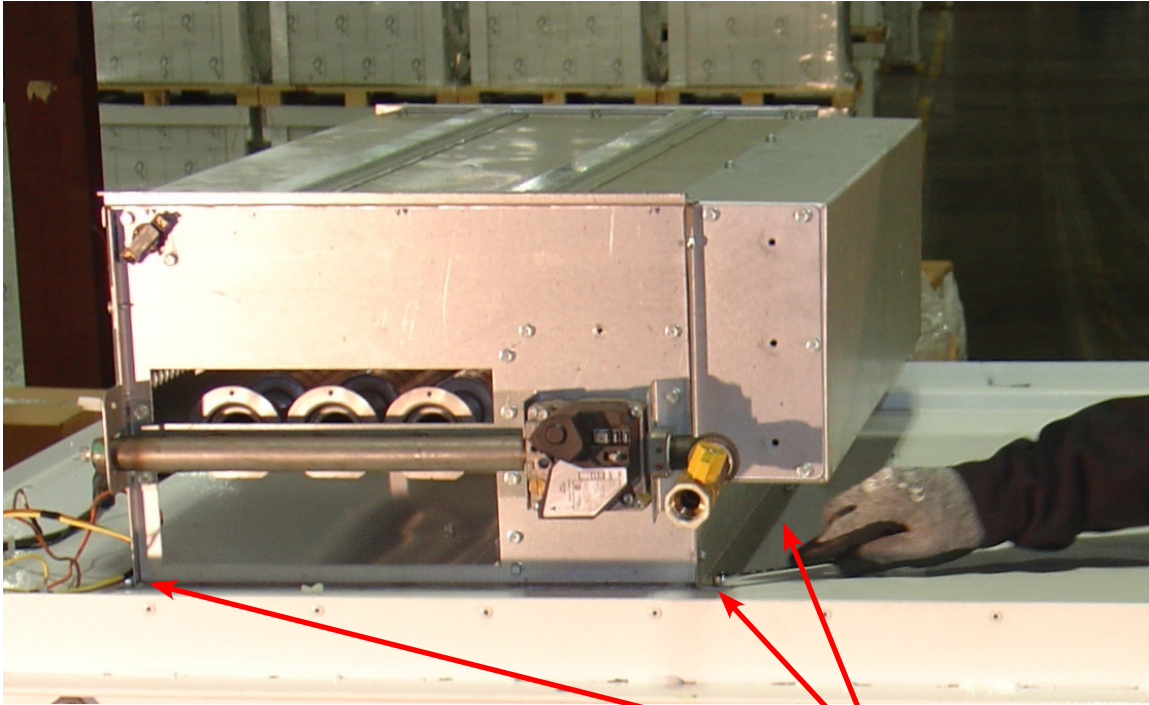

5/16 head screws

- C. Remove the two front 5/16 screws holding burner to top deck.
- D. Remove one Right rear 5/16 screw holding burner to top deck.
5. Next lift left side of the burner 1/2" and slide to the left to free it from the right hold down bracket.
6. After freeing burner from hold down bracket slide burner assembly to the rear and with two people lift burner assembly from top deck.

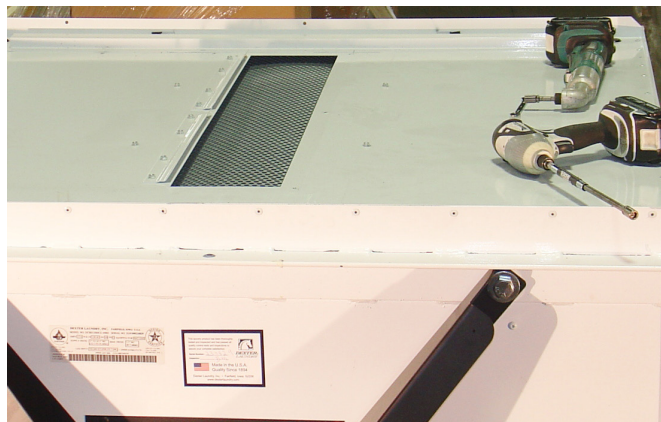

7. Re-assemble in reverse order

Pressure Testing

The dryer and its individual shutoff valve must be disconnected from the gas supply piping system during any pressure testing of that system at test pressures in excess of 1/2 psig (14" water column). The dryer must be isolated from the gas supply piping system by closing its individual manual shutoff valve during any pressure testing of the gas supply piping system at test pressures equal to or less than 1/2 psig.

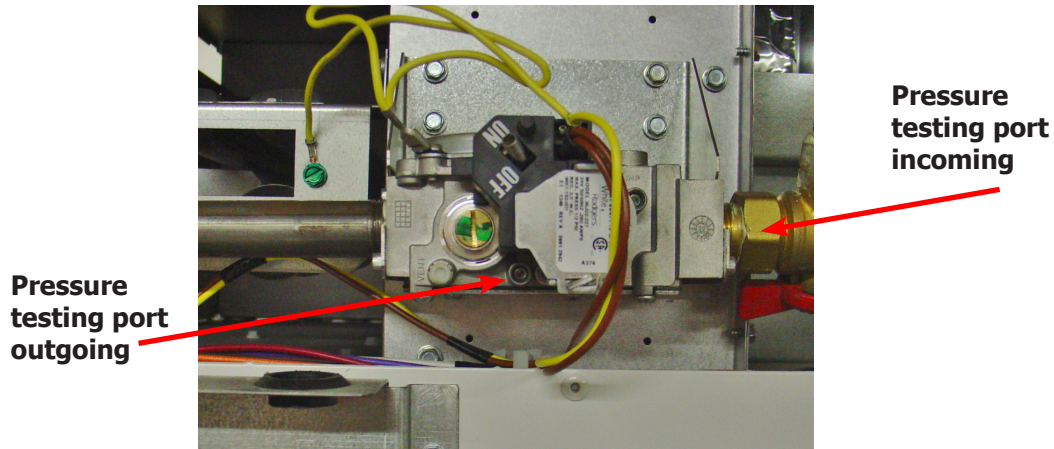

Clothes Door Removal

Step 1: Open door and remove inner hinge plate cover by removing the two Phillips screws.
Step 2: The clothes door may be removed from the hinge bracket by unscrewing and removing the top 3/16 allen head pivot screw located at the door upper hinge point, you will also need to use a 1/4 allen wrench in the lower fastener.
Step 3: Next lean the door out of the top of the hinge bracket and lift the door from the bottom hinge pin.

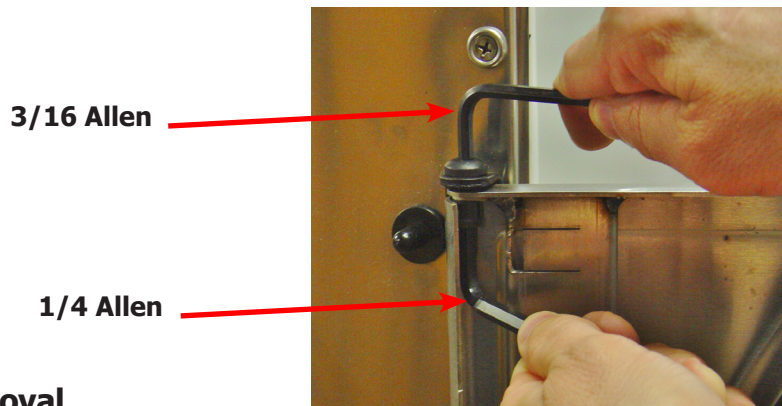

Front Panel Removal

Step 1: Remove the loading door from the panel (optional, the front panel may be removed without taking off the door).
Step 2: Open upper service door, and remove lint door.
Step 3: Then remove the two left side phillips screws w/ beveled washers and the two right side phillips w/ beveled washers screws. Next disconnect door switch wires from back of loading door switch.

Door Switch Removal & Installation

Step 1: Remove front panel (see front panel removal).

Step 2: Next disconnect door switch wires from back of loading door switch. Remove door switch by depressing the bottom tab on the switch with a flat head screw driver. Then slide the bottom of the switch toward the front panel. Pull the switch out at a 45° angle.

Note: For the 80Lb., you will have to remove the door switch cover first by removing the two 3/8" nuts.

Step 3: reassemble in reverse order.

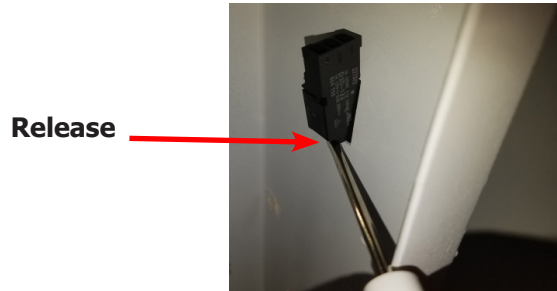

Door Switch Operation & Testing

The normally open door switch must be closed (0 ohms resistance) for the motor and heat circuits to operate. When the door is opened, the door switch opens the 24 volt control circuit.

Clothes Door Latch Adjustment

Step 1: Loosen the lock nut on the latching stud. It is located directly behind the door handle.

Step 2: Open the loading door.

Step 3: Screw the door catch stud in or out as necessary and then retighten the lock nut.



Installation of Clothes Door Window & Gasket

Step 1: Remove the loading door.

Step 2: Place the clothes door, with its face down, on a solid surface.

Note: Pre-warming the gasket under a heat lamp makes the installation much easier.

Step 3: Put the door glass gasket on the loading door with the ridges in the wide side up. Locate the seam at the door latching stud.

Note: The gasket has one narrow opening on one side and a wide opening on the other. The narrow side mounts to the door. The wide side holds the glass. The wide side has ridges on one interior lip. This ridged side should go up with the door lying face down.

Step 4: Coat the inside and outside of the gasket with rubber lubricant or liquid soap.

Step 5: Slide the glass into the middle of the gasket with half of the glass above the door and half below the door.

Step 6: While pressing on the glass, use a modified screwdriver (grind the end off so that it is round and put a slight bend in it) and run it around half of the glass.

Step 7: With half of the glass installed, turn the door over and repeat step 6.

Step 8: Insert the modified screwdriver at the 6 o'clock position and pry the glass up enough to install the door glass support spacer (small diameter rubber tube).



Glass inserted half way

High Limit Thermostat Locations & Functions Burner Housing

This hi-limit is located on the rear of the burner housing.

STEP 1: The thermostat opens the circuit to the main burners in the event of malfunction in the gas control area or temperature control. This thermostat will open quickly if there is a significant loss of air flow over the burner area.

STEP 2: It is held in place by two screws. There are spacers between the thermostat and bracket which must be used to give proper operation.

Removal : To remove the hi-limit thermostat on the side of the burner housing, remove the terminal of each wires attached to the thermostat. Lastly, remove the mounting screws holding the thermostat to the burner housing.

High Limit Thermostat

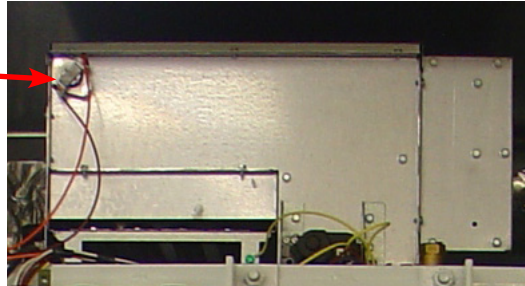

Manual Resettable Over Temperature Safety Thermostat

The second hi-limit thermostat is located outside the rear exhaust opening mounted on the left side of the exhaust duct at the rear outlet height.

Step 1: The manually resettable thermostat limits the operating temperature a dryer can reach should some abnormal situation occur.

Step 2: Should the thermostat be tripped, the dryer will cease to heat until the thermostat is reset. Once the dryer cools, the thermostat may be reset by pushing the button in.

REMOVAL: To remove the manual resettable over temperature safety thermostat next to the exhaust duct. First, remove the terminals of each wire attached to the thermostat. Next, remove mounting screws holding the thermostat to the dryer cabinet.

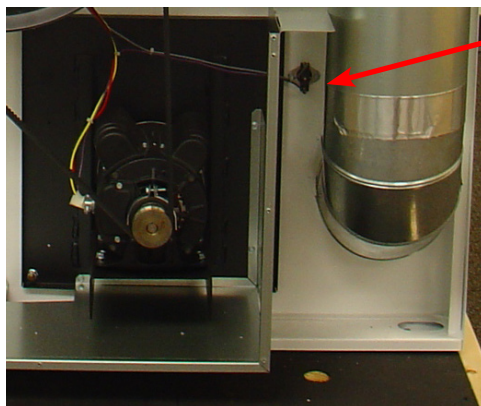

Overtemp Thermostat

Pressure Regulator Adjustment

Use the following procedure whenever it is necessary to check the pressure regulator setting. NOTE: Any adjustment of the pressure regulator must be made with a manometer attached at the plug in the main burner manifold.

Step 1: Shut off the gas supply to the dryer.

Step 2: Remove the 1/8" pipe plug from the end of the main burner manifold.

Step 3: Attach a manometer to the manifold end.

Step 4: Remove the pressure regulator cover screw on the gas valve.

Step 5: Open the shut-off valve, and operate the dryer.

Step 6: Adjust the pressure for a manometer reading of 3.5" water column gas pressure.
(11.0" for L.P.)

NOTE: The main burners must be operating when adjusting the pressure regulator.

Step 7: Shut off the gas supply to the dryer. Remove the manometer and install the 1/8" pipe plug in the manifold.

Step 8: Open the shut off valve, start the dryer and check for gas leaks while the burners are ignited.

NOTE: Always remove power from the machine before changing drive belts or working with the drive and fan system.

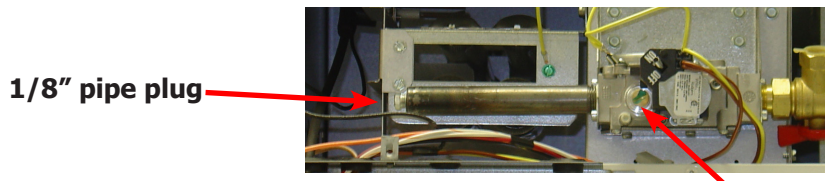

Adjustment Screw Under Plug

Final Drive Belt Replacement

To replace the final drive belt turn the cylinder slowly by hand and work the belt off of the large pulley.

Motor Drive Belt Replacement

To replace the motor drive belt the final drive belt should be removed as above. Next turn the intermediate drive pulley and work the belt off of it similarly to the above belt.

Blower Motor Removal

Step 1: Remove Rear upper and lower Belt pulley guards.

Step 2: Remove rear electrical box cover.

Step 3: Remove left and bottom side guard.

Step 4: Remove belts.

Step 5: Disconnect wires from the over temperature switch and cut the two wire ties securing gray wire to motor harness.

Step 6: Remove the wire clamp holding motor wire loom to cross member by removing the 5/16 screw.

Step 7: Remove the two beaded ties securing harness behind pulleys.

Step 8: Remove last wire tie connecting gray wire to motor harness.

Step 9: Next, inside the rear control box disconnect red wire, 1/4 inch quick connect inside splice connector.

Step 10: Remove black and yellow wires from R1 relay.

Step 11: Remove motor harness from control box.

Step 12: Next remove blower motor, back plate, and impeller from machine by removing the four 9/16 nuts.

Reassemble in reverse order.

Blower Impeller Removal

Remove Blower motor assembly. Take notice of the location of the impeller location on the shaft. Remove the two set screws that hold the motor to the shaft.

Airflow switch removal and adjustment

The air switch assembly is part of the ignition safety circuit and insures that the burner doesn't operate unless there is airflow. If this doesn't happen, ignition will not occur. The air switch assembly is located on the back of the Dryer.

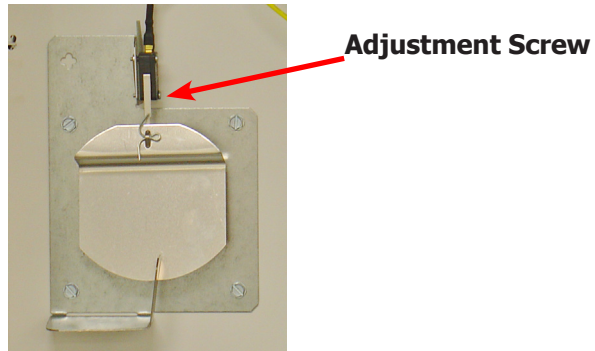

Electronic Ignition Module

This machine uses an electronic spark ignition system to directly light the burners.

Step 1: The electronic ignition module (gray box) is located inside the rear control box.

Step 2: The red wire from the transformer provides 24 VAC through the 1.5 amp fuse and into the module to operate the entire direct ignition system.

Step 3: The black colored hi-voltage wire (spark plug type) plugs onto the post connector on the module, and the multi-wire plug fits into the side of the module.

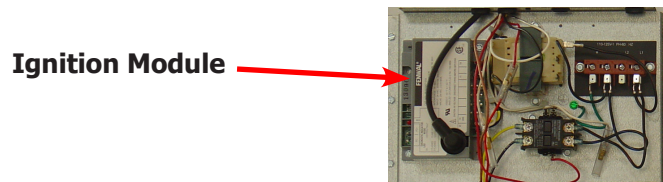

Spark Electrode Assembly-Removal

Step 1: Disconnect wires to electrodes.

Step 2: Remove two screws to detach electrode assembly.

NOTE: Proper grounding of the ignition system (yellow wires) is very critical for proper ignition sequence.

If there is no spark or intermittent spark, check black hi-voltage lead wire for damage or cracks in insulation. This lead wire must not be taped or connected to any metal edges along its length to prevent pinching and arcing. Also, do not bundle this wire with other wires.

Note : Spark gap and electrode location are important. If the electrode is damaged or mounting is changed the spark gap may not be correct for ignition to occur. Check for cracks in the ceramic insulator. Replace electrode assembly if necessary. Also check for carbon or foreign material on the electrodes and clean if necessary.

Gas Valve & Manifold Removal

Step 1: Disconnect union at gas valve and disconnect wires from gas valve operator coils.

Step 2: Remove Gas Valve mounting bracket by removing the 4 5/16 screws.

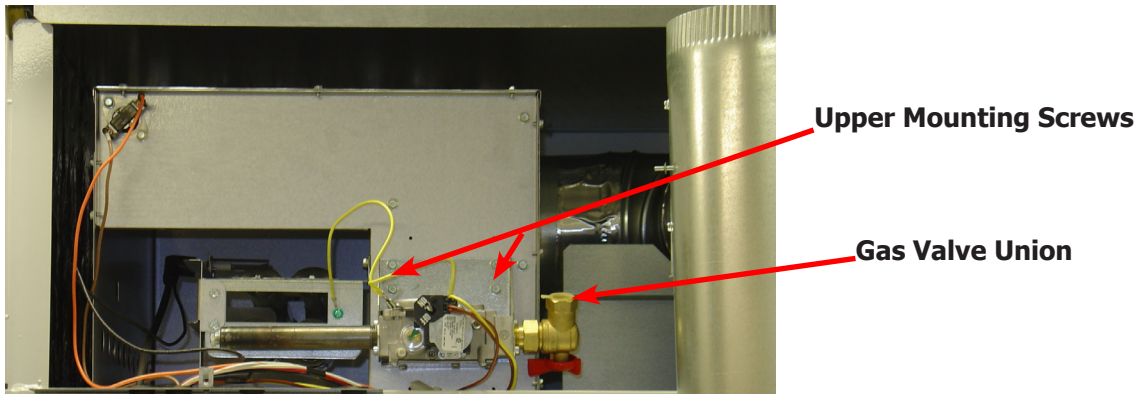

Main Burner Orifice Removal

Step 1: Remove manifold and gas valve assembly as above.

Step 2: Using an open end wrench, remove orifices from manifold.

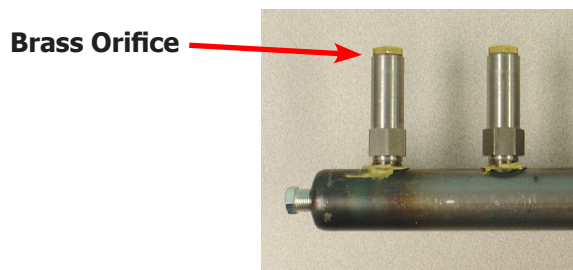

Main Burner Removal

Remove manifold & gas valve assembly as previously discussed. Remove the four 9/16 screws securing the front of the burner to the support bracket. The burners may now be removed.

Cylinder Pulley Removal

30Lb

Remove bolt and washers holding pulley to cylinder shaft. Reinsert bolt then using two or three jaw puller Pull pulley straight off of shaft.

50Lb & 80Lb

Remove bolt and washers holding pulley to cylinder shaft. Reinsert bolt then using "T" puller w/ 3/8-16UNC bolts, Pull pulley straight off of shaft.

Intermediate Pulley Removal

30Lb & 50Lb

The intermediate pulley can be removed by removing the snap ring holding the pulley to the tension arm.

Note: Cylinder pulley must be removed first.

80Lb

The intermediate pulley can be removed by removing the nut holding the pulley to the tension arm.

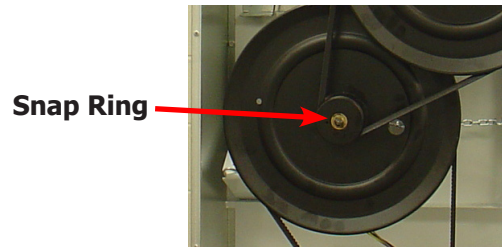

Tension Arm Assembly Removal

The tension arm assembly may be removed by removing the snap ring that holds it to the tension arm support assembly pin. If it is necessary the arm assembly is replaced as a complete unit.

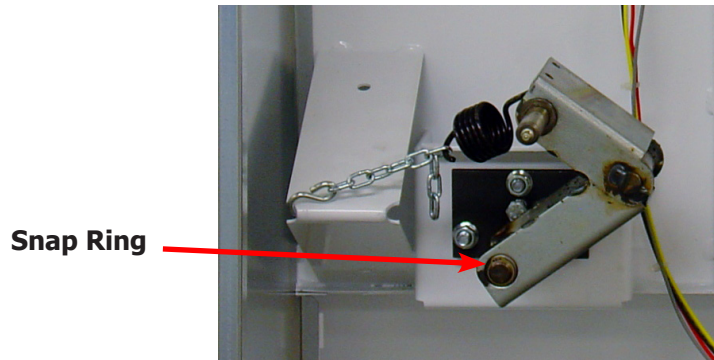

Tension Arm Support Assembly Adjustment

The tension arm support assembly may be adjusted for alignment of the intermediate pulley and also to align the belts. The three outer nuts allow the alignment of the pin to be adjusted by pivoting the assembly on the center bolt. The center bolt can be screwed in to allow bringing the complete assembly farther back if necessary for belt alignment.

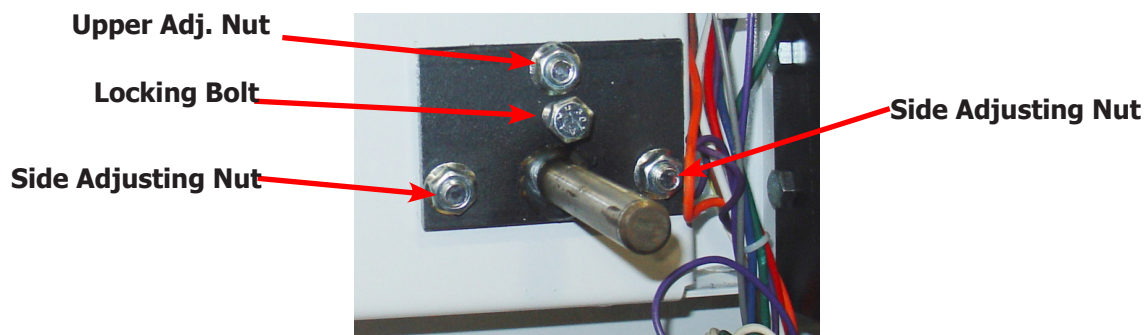

Cylinder Removal

Step 1: Remove the front panel in front of the cylinder.

Step 2: Remove drive belt, bolt, washers, and pulley.

Step 3: Pull the cylinder from the front of the machine.

Adjustment of Cylinder Assembly

- Step 1:** Loosen the two top adjusting bolts and two bottom adjusting nuts and lock nuts holding the bearing housing to the drive plate.
- Step 2:** Loosen the four mounting bolts on the side channels.
- Step 3:** Open the clothes door and insert a 1/2" thick shim at the 3 and 9 o'clock positions and a 1/4" thick shim at the 6 o'clock position.
- Step 4:** Tighten the two bottom adjusting nuts and tighten locking nuts.
- Step 5:** Tighten the bottom right mounting bolt, then the top left mounting bolt. Tighten the remaining two bolts. (Shim where and if necessary.)
- Step 6:** Tighten the two top adjusting bolts.
- Step 7:** Remove all the shims from between the front panel flange and cylinder. (3,6,9 and 12 o'clock).
- Step 8:** Spin the cylinder to check for rubbing baffles, pressing down hard while rotating. If rubbing is detected, repeat procedure paying particular attention to placement of shims between bearing housing and side channels.

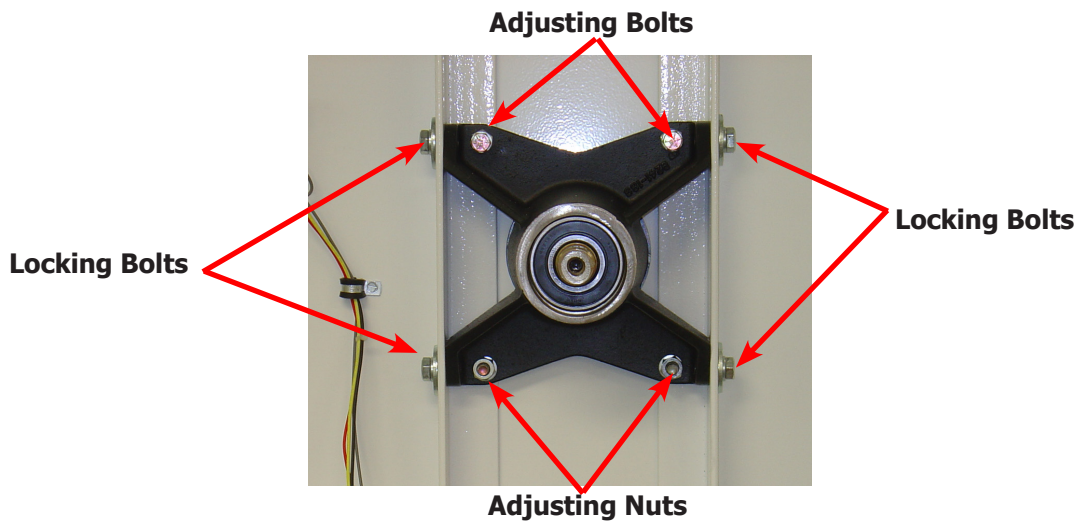

Bearing Housing Removal

After removing cylinder as previously outlined, simply unbolt the four outside bolts and the two lower nuts and remove the bearing housing.

Spark Electrode Assembly-Function

Step 1: The spark electrode and sensing electrodes are located directly at the side of the burner housing.

Step 2: The electrode with the black hi-voltage wire conducts the spark to the center grounding probe, directly over the burner.

Step 3: The electrode with the black sensing wire detects ignition and monitors flame by signaling the module.

NOTE: Proper grounding of the ignition system (yellow wires) is very critical for proper ignition sequence.

Ignition System-Function & Sequence

During normal dryer operation, the following occurs:

1. The dryer electronic control calls for heat.

2. From the 24VAC control transformer, voltage for the heat circuit is applied to the control through the door switch. If the control detects that the heat should be on, a circuit is closed providing power through the over-temp thermostat, the air damper switch, the high limit switch and the motor centrifugal switch to the Ignition Module. Once the 24VAC reaches the ignition module on the red wire, sparking occurs at the ignition electrode and 24VAC is applied to open the Gas Valve.

3. Once the flame is established, the sensing electrode detects the presence of flame and the sparking stops.

4. If for any reason the flame is not established in a period of 10 seconds, the electronic control will try this sequence for 3 tries. Normally the 10 seconds "Trial For Ignition" period is ample to establish and prove flame.

5. If the flame is shutdown or blown out during operation, the ignitor will immediately go into "Trial. For Ignition" again for 10 seconds.

6. However, at the end of 3 separate retries of 10 seconds "Trial for Ignition", the flame is not established, the ignition system goes into "Safety Lock-Out" and will not reactivate the "Trial for Ignition" until there is a current interruption for a period of 15 seconds. This interruption can be provided by opening the dryer loading door and allowing the machine to come to a complete stop for 15 seconds.

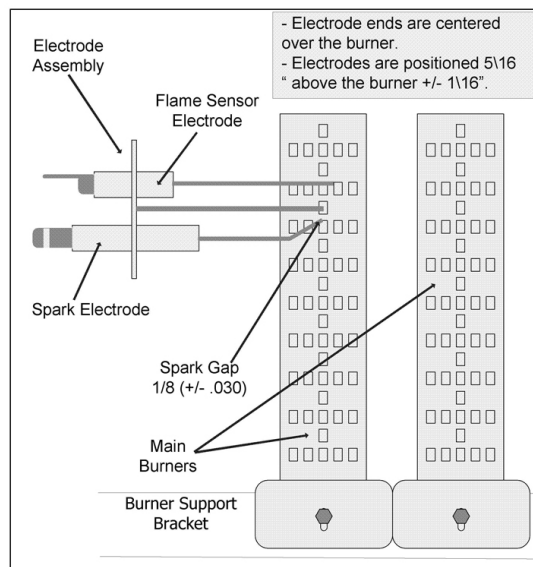

Dryer Trouble Shooting

Symptom	Probable Cause	Suggested Remedy
Tumbler does not turn	Drive belts	Check both drive belts. Replace if failed.
	Tumbler does not turn	Check capacitor and motor. Replace if failed.
	Door switch	Check door switch contacts and adjustment. Adjust or replace door switch.
	Timer Tumbler does not turn	Check to see if heat timer is turned on.
Tumbler turns but no spark at burner	Glass fuse	Check small glass control fuse in back of dryer. Replace if failed.
	Thermostat	Check if voltage is passing through the two wires attached to the temperature thermostat
	Ignition	Check for 24VAC output from transformer.
	Transformer	Replace if have 120VAC between black & white and no 24VAC between red and yellow.
	Over temperature	Check to see if manually resettable thermostat. Thermostat is kicked out. Reset by pushing red reset button.
	Ignition control	Check for 24VAC coming into the control on the at burner red wire. If voltage, then check for 24VAC out on the brown wire. Also check for spark at the ignitor. If no 24VAC output or no spark to the ignitor, replace ignition control.
	Air Flow Switch	Check air flow switch to be sure it closes when dryer is running. If not, adjust or replace switch.
	Hi-limit	Check for continuity. Should be 0 ohms resistance when cold. If not, replace thermostat.
Gas supply	No gas can cause system lockout.	

Dryer Trouble Shooting

Symptom	Probable Cause	Suggested Remedy
Tumbler turns, ignition sparks, no flame	Gas supply	Make sure gas supply is working.
	Gas pressure	Make manometer check of gas pressure. Adjust if necessary.
	Spark Electrode Sensor	Check for damage to electrode or mounting. Replace if necessary.
	Gas valve	Check coil continuity, replace valve if failed.
	Ignition Control	Check for 24VAC to gas valve coils. If no voltage replace ignition control.
Burner Lights, but goes on and off	Electrodes	Check low voltage harness for possible wire break or cuts to allow no signal back to ignition control.
Slow drying	Temperature Setting	Check thermostat for correct high temperature setting. Adjust if necessary.
	Air flow restrictions necessary	<ol style="list-style-type: none"> 1. Check lint screen and clean if necessary. 2. Check exhaust for correct length and clean if necessary. 3. Check exhaust damper to insure that it opens when dryer is running and closes when dryer is not in use. 4. Check makeup air to insure that it is adequate. Increase makeup air if necessary. 5. Check static Back pressure no more than .3
Manual overtemp Tripping Frequently	Recirculating chamber Lint Accumulation	Remove manual overtemp thermostat and inspect in chamber for excessive lint build up. Access also gained to this chamber by removing recirculation duct mounted at bottom of chamber, or the panel inside burner chamber between burners and rear back panel.
	Exhaust ducting Excessive lint buildup	Remove exhaust duct at rear of dryer and inspect for excessive lint build up in complete duct from dryer to where duct exits building.
	Clean lint from top heat air chamber above tumbler	Remove front panel completely. Be careful of any wiring attached. Remove heated air chamber cover and clean above tumbler back to burner housing.

Error Codes

Symptom	Probable Cause	Suggested Remedy
TEMP SENSOR SHORT	Shorted Temperature Sensor or wire.	The dryer control shall not start until the detected short circuit is removed. Regardless of condition of short circuit, Error Code will be displayed until programming button is pressed to return machine to idle mode.
TEMP SENSOR OPEN	Open Temperature Sensor or wire	The dryer control shall not start until the detected short circuit is removed. Regardless of condition of short circuit, Error Code will be displayed until programming button is pressed to return machine to idle mode.
PCB ERROR1	Memory corrupted	Power machine down and try to reset control. Verify voltage to the control board. Check ground to board. Replace control board if error can not be cleared.
PCB ERROR2	Analog/ Digital Error	Power machine down and try to reset control. Verify voltage to the control board. Check ground to board. Replace control board if error can not be cleared.
COMM ERROR1	Communication Bus Error	Power machine down and try to reset control. Verify voltage to the control board. Check ground to board. Replace control board if error can not be cleared.
COMM ERROR2	No Dryer Model Selected	This error occurs when a pin combination on the model selection header is used that does not have a model designated for it. Check connector marked Jumpers on the control board.
COMM ERROR7	Communication Bus Error	If connected to DexterLive, Disconnect cable, and preform a soft restart by holding down the program button on power up. Preform Soft restart. Contact your Dexter factory representative.
Fuse Error	Internal Control program Error.	Internal IC issue. Replace control.
CRC ERROR	Firmware Corrupted	The error is fatal. The control must be replaced.

Wiring Diagram for 60hz Dryer -10BD

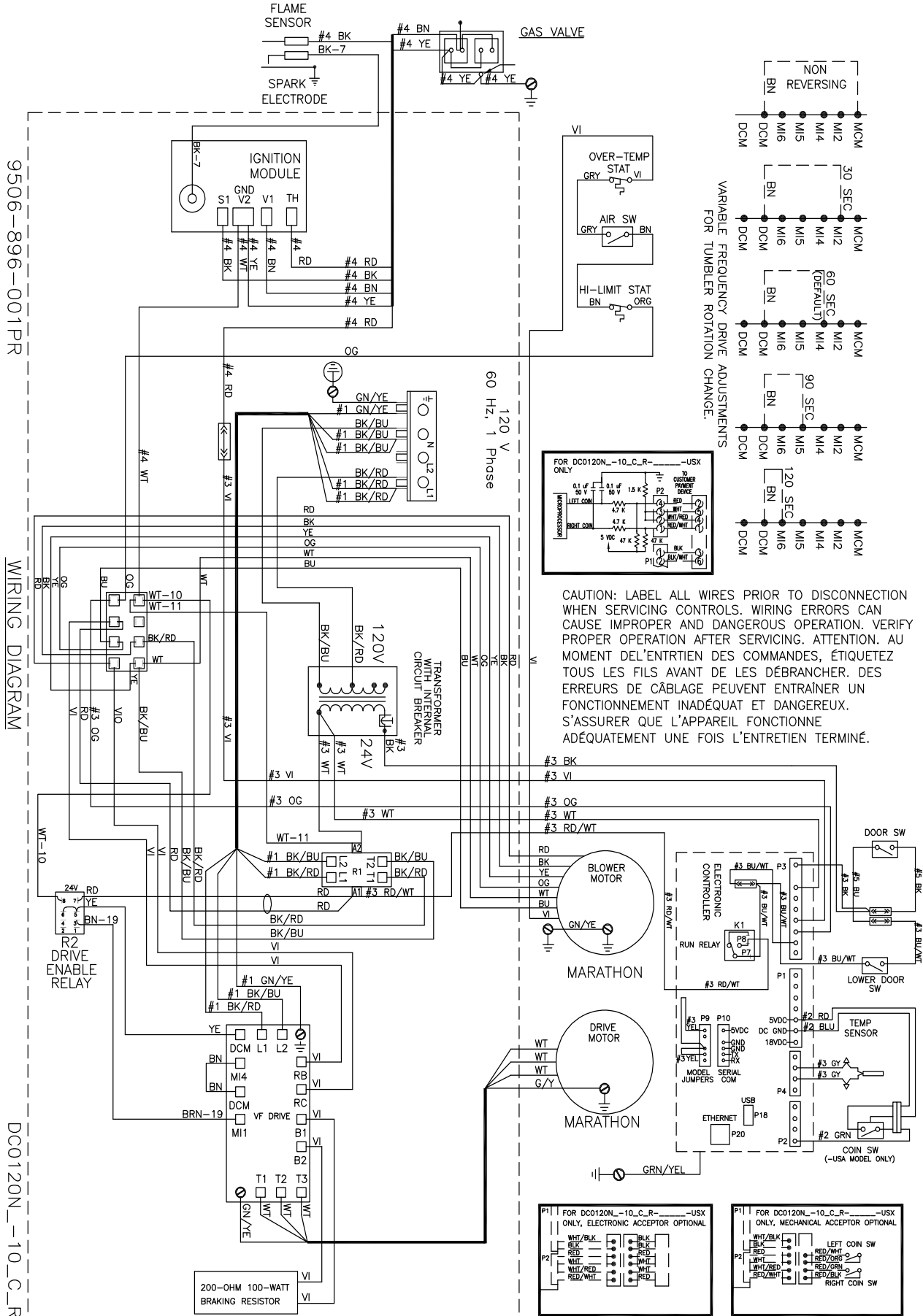

Wiring Schematic for 60hz Dryer -10BD

9506-896-001PR

SCHEMATIC

DC0120N-10_C_R

CAUTION: LABEL ALL WIRES PRIOR TO DISCONNECTION WHEN SERVICING CONTROLS. WIRING ERRORS CAN CAUSE IMPROPER AND DANGEROUS OPERATION. VERIFY PROPER OPERATION AFTER SERVICING. ATTENTION: AU MOMENT DEL'ENTRIEN DES COMMANDES, ETIQUETEZ TOUTS LES FILS AVANT DE LES DERANCHER. DES ERREURS DE CABLAGE PEUVENT ENTRAINER UN FONCTIONNEMENT INADEQUAT ET DANGEREUX. S'ASSURER QUE L'APPAREIL FONCTIONNE ADEQUATEMENT UNE FOIS L'ENTRIEN TERMINE.

IMPORTANT: RETAIN THIS ELECTRICAL SCHEMATIC FOR SERVICE.

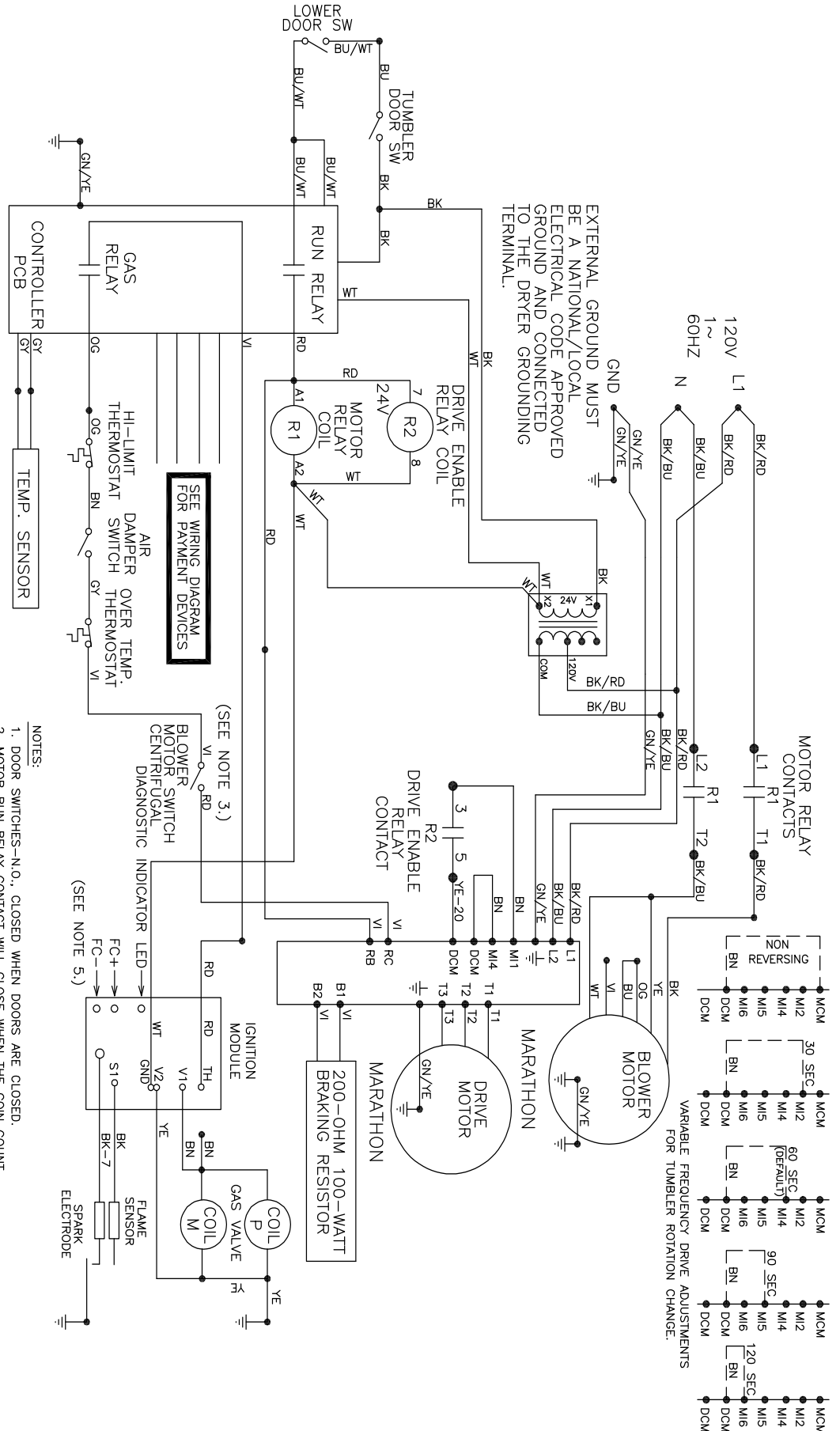



DC0120NE-10EC2R

Section 5:

Dryer Parts Data

Dryer Cabinet Front Panel

Key	Description	T-120	
*	Loading Door Complete Wht/Brushed SS/Blk	9960-331-001	1
1	Door Assy, Loading (Ring only) Brushed SS	9960-331-001	1
*	Doorassy-load,ss/chr/blk (Chrome)	9960-331-002	1
2	Plate Assy, Hinge	9982-398-001	1
*	Cover-Hinge Back, Black	9982-397-001	1
*	Screw-10Bx3/8, Black	9545-008-010	2
*	Screw Hinge to Door	9545-012-015	4
*	Nut, Hinge to Door	8640-413-002	4
3	Glass, Door	9212-002-006	1
*	Adhesive-Door Glass, 10.3 oz. tube (24-Hour Cure Time)	8561-138-002	1
4	Optical Coin Acceptor	9021-094-001	1
*	Optical Coin Acceptor Extension Harness	9627-916-004	1
*	Retainer-coinacceptor	9486-145-001	1
*	Electronic Coin Acceptor Kit (Optional)	9732-303-004	1
*	Nut, Elastic Stop	8640-413-004	*
*	Electronic Coin Acceptor Extension Harness (Optional, NOT included in Kit above)	9627-909-006	1
5	Gasket, Door Outer Rim (Black)	9206-420-007	1
6	Handle, Loading Door	9244-093-001	1
*	Screw, Handle	9545-018-017	2
7	Stud Door Catch 7/8"	9531-033-002	1
8	Nut-Hex, #10-32	8640-413-001	1
9	Nut, Acorn	8640-413-003	1
*	Catch, Loading Door	9086-015-002	2
*	Rivet	9491-009-004	2
10	Strap, Hinge (Black)	9966-023-002	1
*	Channel Assy.-Front Panel	9947-024-001	1
*	Screw-Phillips, 10-32x1/2 Chrome	9545-012-028	4
*	Screw-Phillips-Counter sink, 10-32x1/2 Chrome	9545-012-003	2
11	Screw-Special, Hinge to Door	9545-052-001	1
*	Nut-Allen, 1/4-20S	8640-439-001	1
12	Washer-Fiber/Plastic	8641-436-006	1
13	Front Panel Assy (Blk) Round Switch	9989-688-001	1
13	Front Panel Assy (Blk) Square Switch	9444-011-001	1
*	Insulation-Front Panel	9277-065-001	1
*	Label-Warning	8502-758-001	1
14	Screw-Phillips, 10Bx1 3/4	9545-008-014	10
15	Washer-Finish	8641-585-001	10
*	Nut-Spring	8640-399-001	10
*	Switch-Door (Round)	9539-492-001	1
*	Switch-Door (Square)	9539-501-001	1
17	Vaultassy-coin,black	9942-039-002	1
18	Controlasy-t120coin, 1.5,24 (Blk)	9857-199-006	1
*	Controlasy-t120coin, 1.5,24 (Blu)	9858-199-005	1
19	Overlay-Controltrim,-t-120, (Blk)	9435-067-001	1
	Overlay-Controltrim,-t-120, (Blu)	9435-067-002	1
*	Door switch harness	9627-948-001	1
*	Cabinet Touch Up Paint (White)	9472-001-013	1

Dryer Cabinet Group

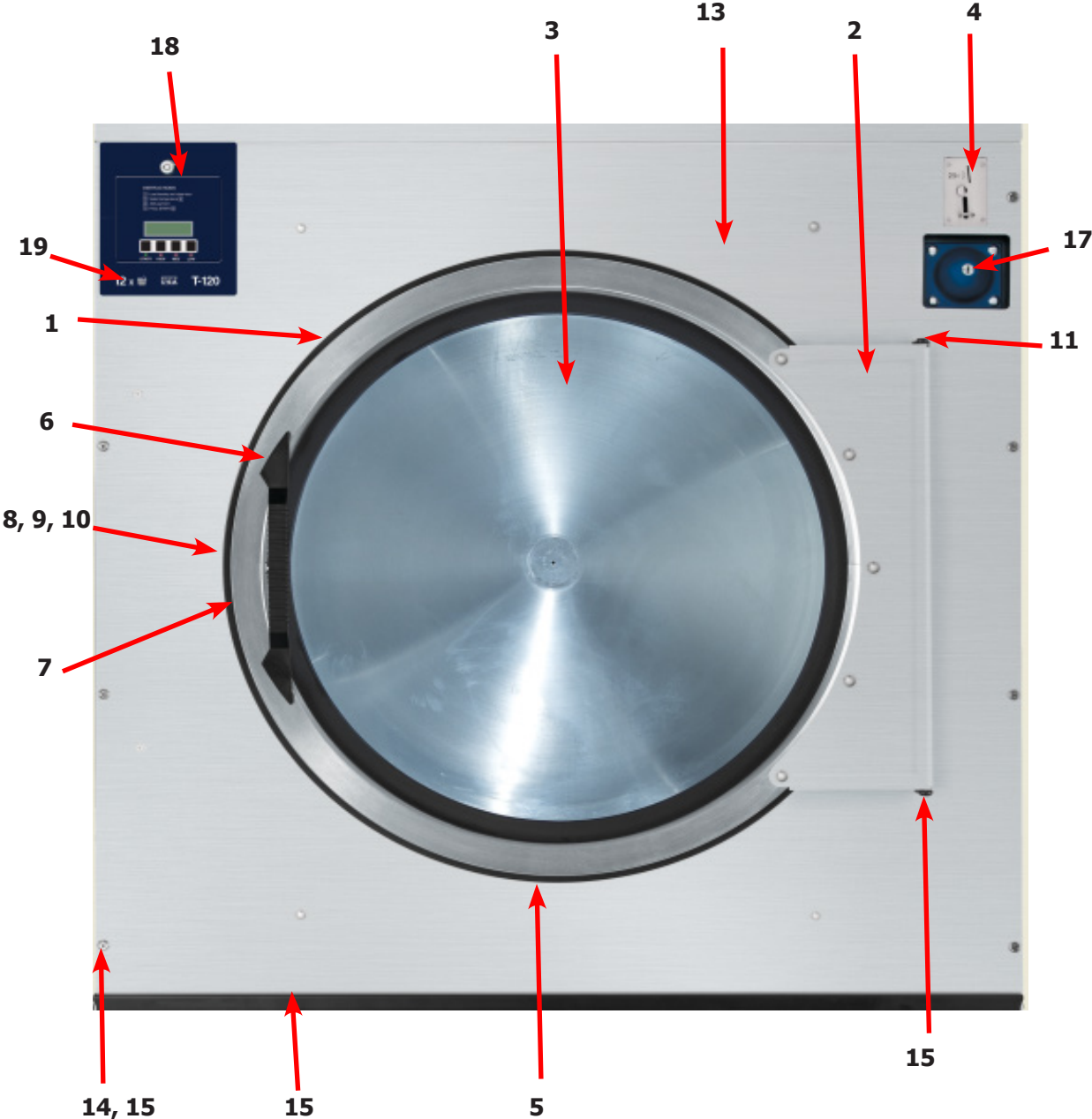

Dryer Cabinet Group Continued

Key	Description	T-120	QTY
1	Nameplate - Dexter Dryer Black	9412-216-001	1
2	Panel Assy-Upper	9960-328-007	1
3	Screw-Phillips, 10Bx1 3/4	9545-008-014	4
4	Washer-Finish	8641-585-001	4
*	Nut-Spring	8640-399-001	4
5	Lockassemblyandkey	8650-012-003	1
*	Cam-lock	9095-041-001	1
*	Washer-flat	8641-851-041	1
*	Key, 6324	6292-006-007	4
6	Overlay-Controltrim,-t-120, (Blk)	9435-067-001	1
*	Overlay-Controltrim,-t-120, (Blu)	9435-067-002	1
7	Controlasy-t120coin,1.5,24 (Blk)	9857-199-006	1
*	Controlasy-t120coin, 1.5,24 (Blu)	9858-199-005	1
8	Front Panel Assembly Round Switch	9989-688-001	1
8	Front Panel Assembly Square Switch	9444-011-001	1
*	Insulation front panel	9277-065-001	1
*	Switch-Door (Round)	9539-492-001	1
*	Switch-Door (Square)	9539-501-001	1
*	Screw, #10-32 x1/2 Green	9545-008-027	1
9	Escutcheon Assemble-coin, t-120	9994-052+001	1
10	Optical Coin Acceptor	9021-094-001	1
*	Optical Coin Acceptor Extension Harness	9627-916-001	1
*	Retainer-coinacceptor	9486-145-001	1
*	Electronic Coin Acceptor Kit (Optional)	9732-303-004	1
*	Electronic Coin Acceptor Extension Harness (Optional, NOT included in Kit above)	9627-909-006	1
11	Vaultassy-coin,black	9942-039-002	1
*	Harness-Control	9627-770-002	1
*	Door switch wireharness	9627-948-001	1
*	Harness-Temp Probe	9627-679-002	1
*	Label-Warning	8502-758-001	1
*	Wiringharness-optcoin,t-120	9627-916-004	1
*	Wiringharness-main,t-120	9627-949-001	1
*	Wireasy-grn/ylw,#16,24"	8220-137-001	1



Dryer Cabinet Group Continued

Key	Description	T-120	QTY
*	Assembly-Door-Lower Service, OPL, Wht (Number 1 thru 14)	9960-307-001	1
1	Door-Lower Service, OPL, Wht	9108-148-003	1
2	Handle-Door, Lower Service, Black	9244-090-002	1
*	Screw-Phillips, 10Bx3/8, Black	9545-008-010	5
*	Cam-lock	9095-041-001	1
*	Washer-flat	8641-851-041	1
*	Key, 6324	6292-006-007	1
3	Lockassemblyandkey	8650-012-003	2
4	Trim-Lower Kick, Black	9578-100-002	1
5	Screw-Phillips, 10Bx3/8, Black	9545-008-010	5
6	Bracket, Lower door switch, (Hinge Bracket)	9029-226-001	2
7	Rivet, 1/8 Low Profile	9491-009-004	4
8	Nut, Elastic Stop, 10-32 UNF	8640-413-007	2
9	Screw. 10-32 x 1/2"	9545-012-003	1
*	Screw. 10-32 x 1/2"	9545-012-003	1
10	Insulation	9277-059-001	1
11	Switch-Door (Round)	9539-492-001	2
*	Switch-Door (Square)	9539-501-001	1
12	Screen Assy, Lint	9822-033-001	1
*	Leg, Leveling 1/2"	8544-006-001	4
*	Leveling Leg Wrench	8545-061-002	1

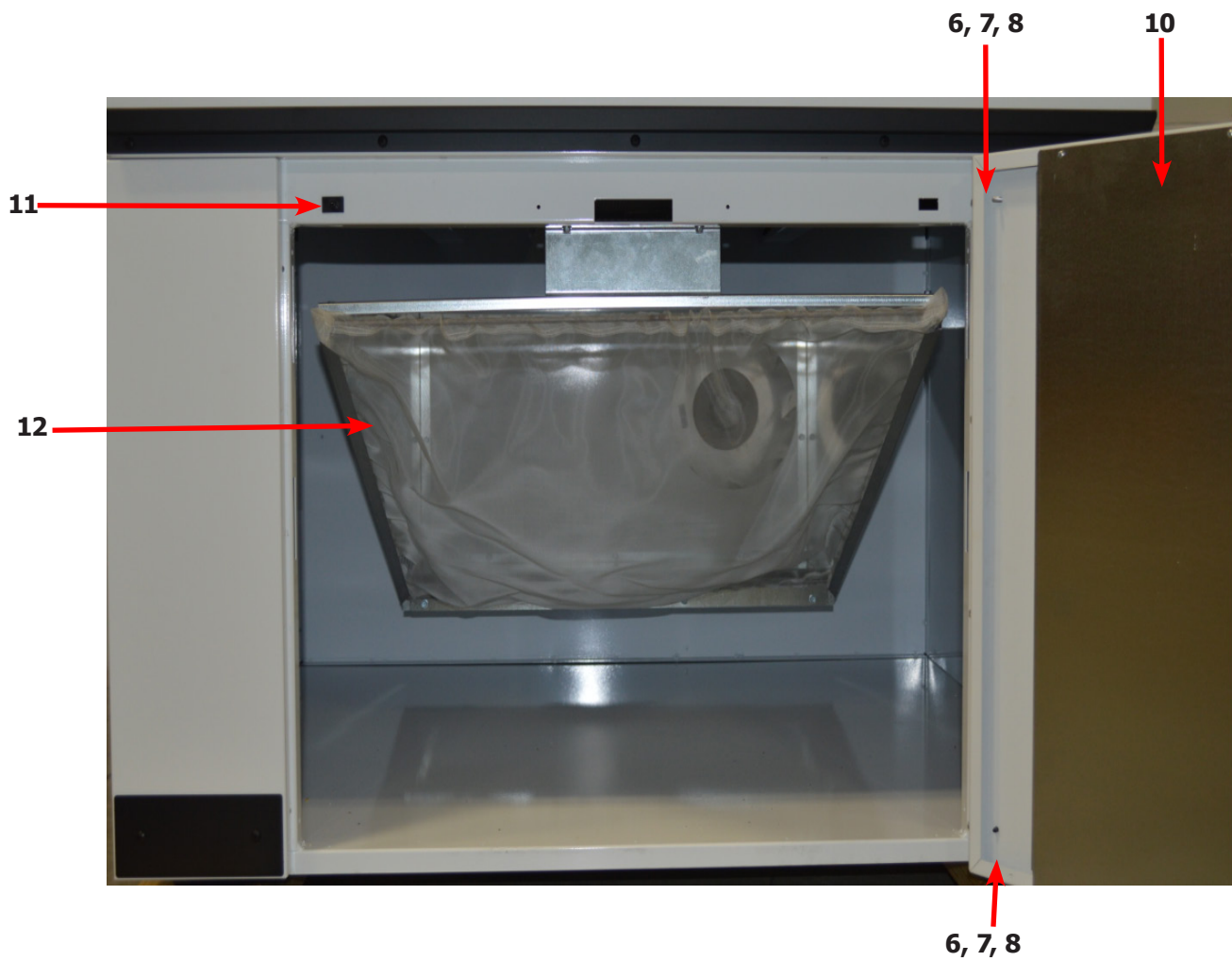
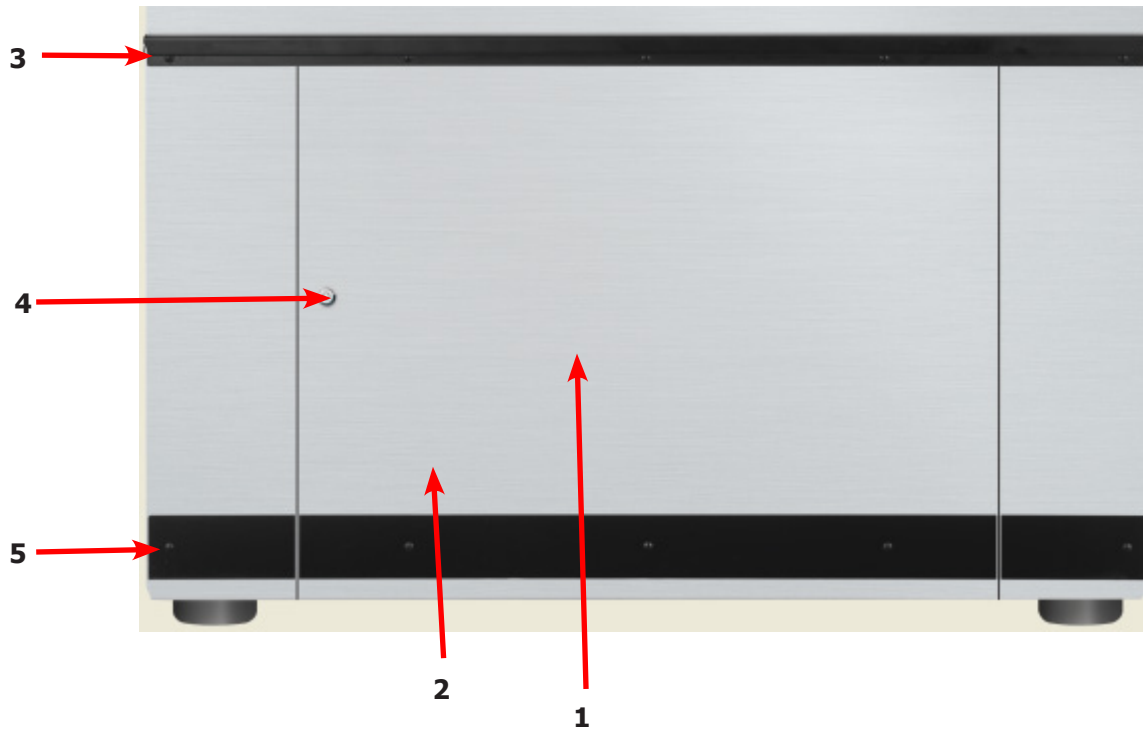

Dryer Cabinet Group Continued

Key	Description	T-120	QTY
1	Panel Assy.-Upper Right	9989-549-002	1
*	Screw, 5/16- 10ABx3/8	9545-008-024	2
2	Insulation-Right Upper, Burner Area	9277-041-022	1
3	Panel Assy.-Upper Left	9989-550-002	1
*	Screw, 5/16- 10ABx3/8	9545-008-024	2
4	Insulation Tumbler Area, Right (Front & Back)	9277-051-005	2
4	Insulation Tumbler Area, Right (Center)	9277-051-006	1
5	Insulation Tumbler Area, Left (Front & Back)	9277-051-005	2
5	Insulation Tumbler Area, Left (Center)	9277-051-006	1
6	Switch-Door (Round)	9539-492-001	2
*	Switch-Door (Square)	9539-501-001	
*	Screen Assy, Lint	9822-033-001	1
*	Lint Hood Assembly	9834-012-001	1
7	Lint Hood, Top	9240-048-001	1
*	Lint Hood, side left	9240-049-001	1
*	Link Hood, side right	9040-049-002	1
8	Lint Hood, Bottom	9058-030-001	1
9	Lint Hood, Angle	9003-333-001	1
10	Screw, 5/16- 10ABx3/8	9545-008-024	22
11	Hinge-Door, Lower	9243-083-002	1
*	Screw-5/16, 10ABx3/8	9545-008-024	5
12	Impeller, w/set screws	9278-041-001	1
13	Harness -Temp Probe	9627-949-001	1
14	Wire Nut, #71B	8640-276-005	2
15	Temp Probe	9501-004-003	1
16	Screw-Phillips, 8Bx1/4	9545-045-005	1
17	Bracket, Temp Probe	9029-111-001	1
18	Screw, 8AB x 3/8	9545-045-008	4
19	Trim-Edge, Lint Hood	9578-092-003	2
20	Lowerservicedoor-Hinge, black	9243-084-003	
21	Strapasy-hinge, lwrservdr	9966-022-001	11

120Lb. Temp Probe

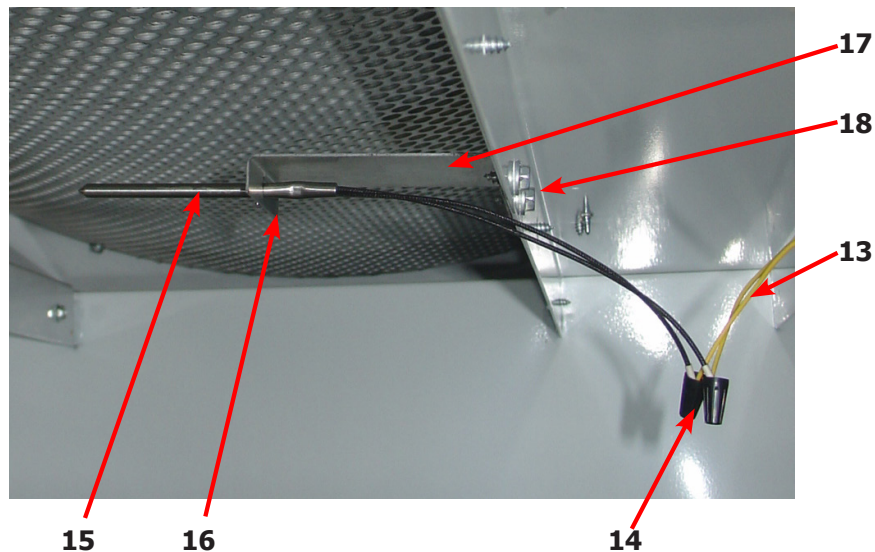

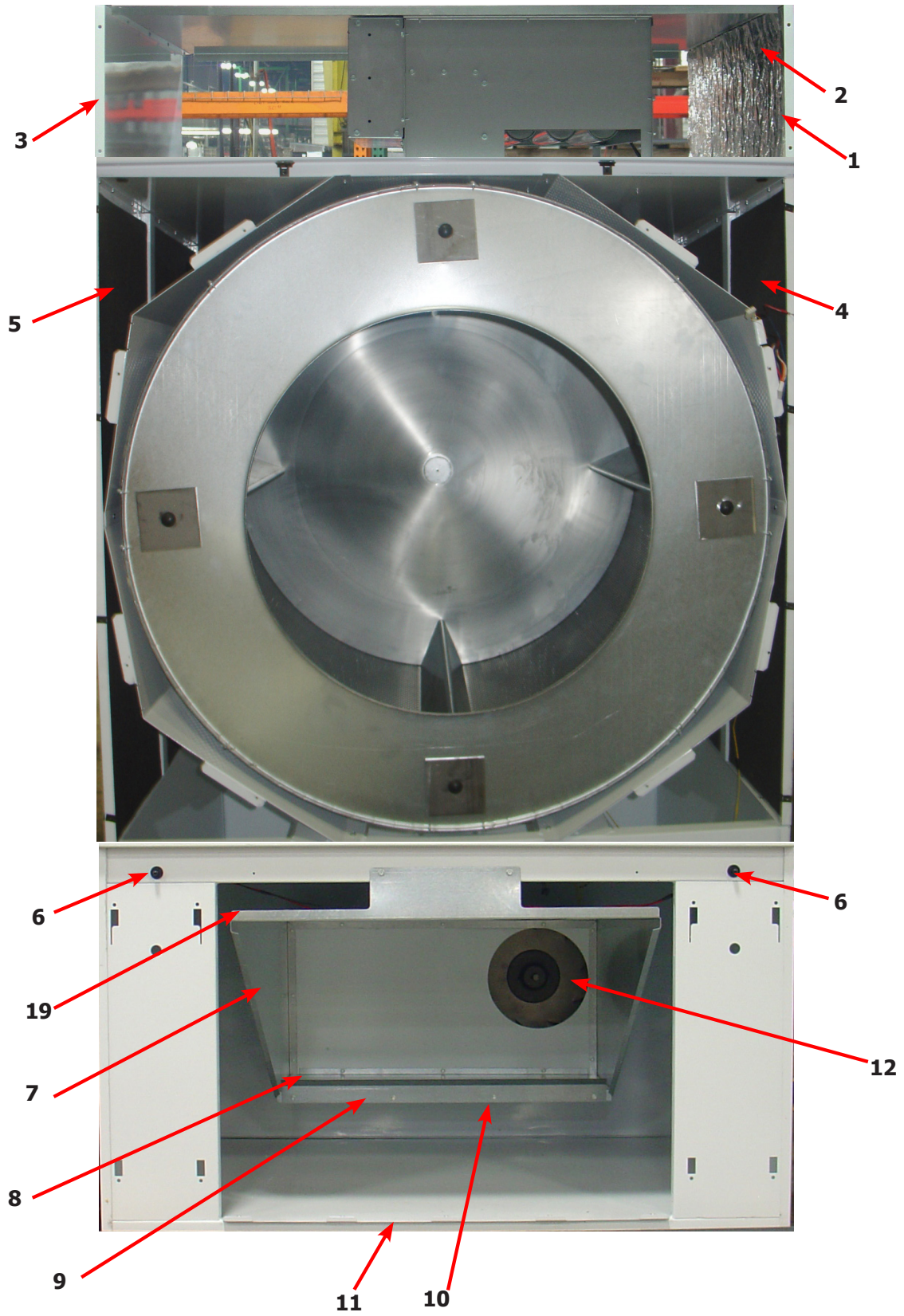

Dryer Rear View 120Lb Reversing

Key	Description	T-120	QTY
1	Pulley, Driven	9453-168-003	1
2	Tolerance Ring	9487-234-006	1
3	Washer -Flat	8641-581-032	1
4	LockWasher - IntTooth, 1"	8641-582-018	1
5	Screw, 5/8-11 x 1 1/2	9545-060-001	1
6	Belt-Driven	9040-076-005	2
*	Impeller, 5" x 16"	9278-041-001	1
7	Plate Assembly-Impeller	9982-375-002	1
8	Nut-Wiz Lock, 5/16-18	8640-400-003	6
*	Gasket-Impeller Housing	9206-428-002	1
9	Motor-Blower, -10	9376-334-001	1
*	Run Capicator	5191-108-005	1
*	Start Capicator	5191-109-005	1
10	Screw, 5/16-18 x 5/8	9545-014-004	4
11	Nut-Wiz Lock, 5/16-18	8640-400-003	4
12	Thermostat-Overtemp	9576-207-006	1
13	Screw-10AB x 3/8	9545-008-006	2
14	Pulley, Intermediate, w/Bearings	9908-051-001	1
*	Bearings-Ball	9036-159-011	2
*	Spacer-Bearings	9538-186-001	1
*	Ring-Retaining, Internal	9487-238-006	1
15	Washer-Flat	8641-581-039	1
16	Nut, 5/8-11	8640-425-002	1
17	Belt, Motor	9040-076-008	1
18	Motor, Drive	9376-307-003	1
19	Pulley-Motor	9453-074-002	1
20	Bushing, Motor -Support	9497-222-008	2
21	Rod-Motor Mounting, Black	9497-222-008	1
22	Collar-Shaft, w/Set Screws	9076-052-002	1
23	Chain-Belt tension	9099-012-004	1
*	Hook-S Type	9248-022-002	1
24	Spring, Belt Tension	9534-151-000	1
25	Duct-Transition, 12" to 10"	9109-124-001	1

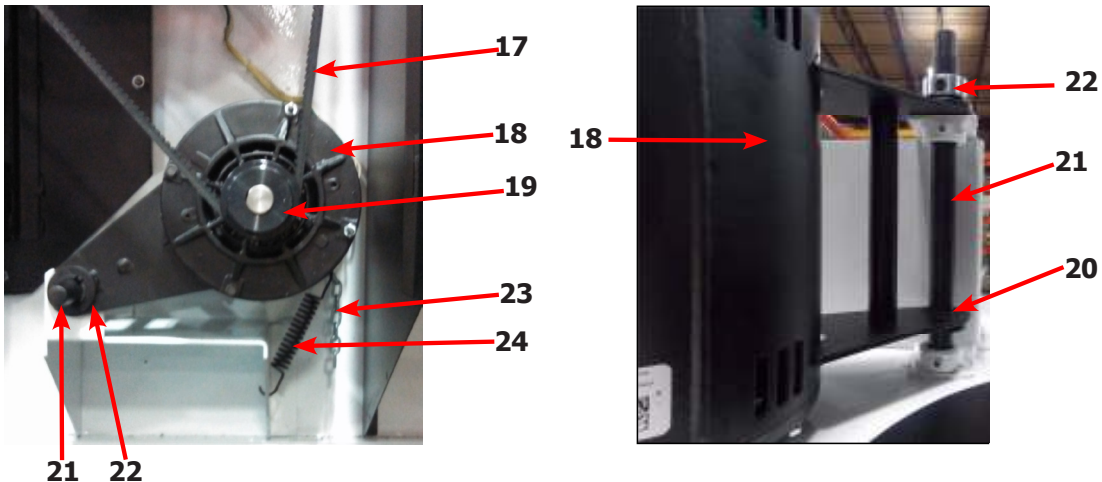

Dryer Rear View 120Lb Reversing

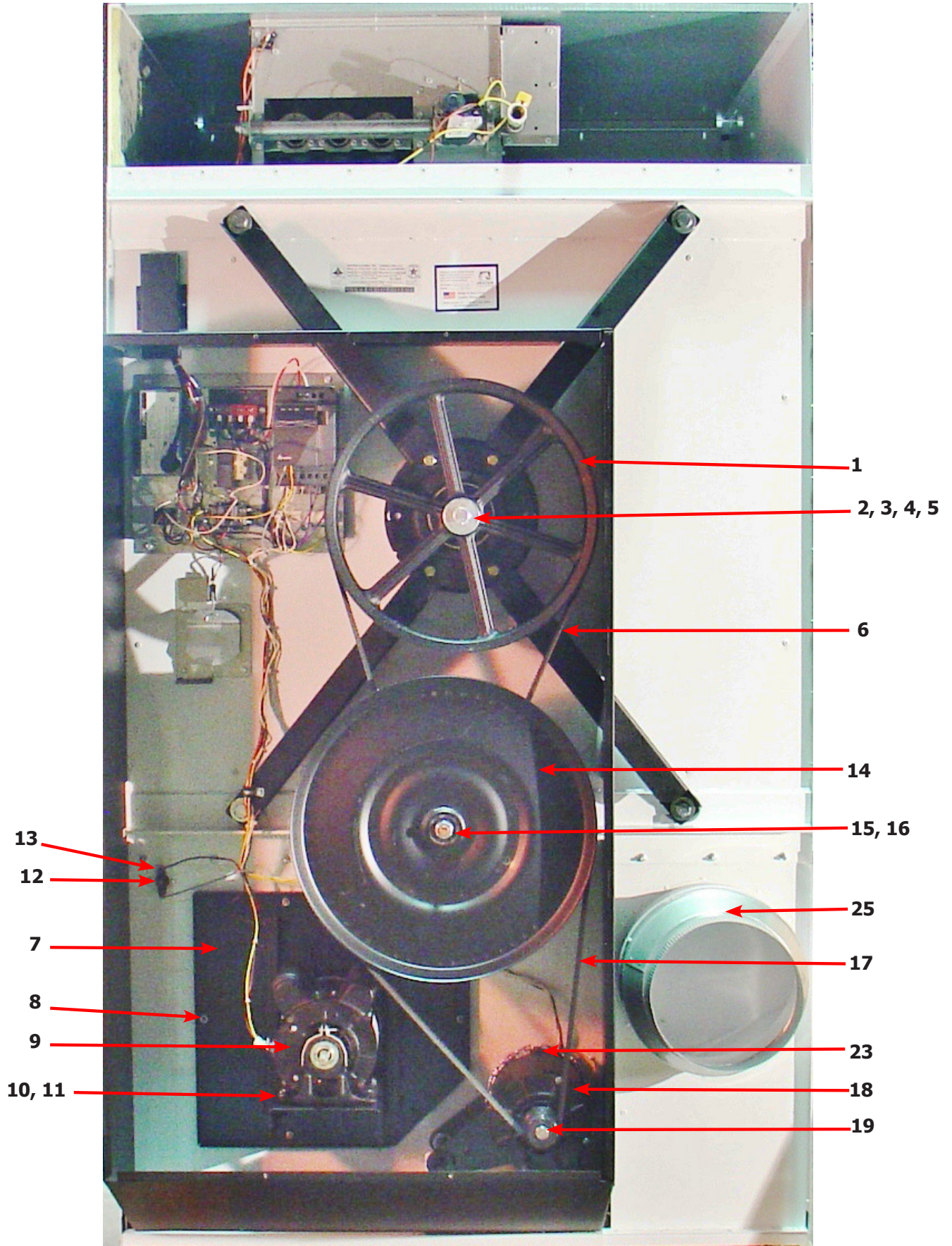

Dryer Rear View 120Lb Reversing Continued

Key	Description	T-120	QTY
1	Pulley, Driven	9453-168-003	1
2	Tolerance Ring	9487-234-006	1
3	Washer -Flat	8641-581-032	1
4	LockWasher - IntTooth, 1"	8641-582-018	1
5	Screw, 5/8-11 x 1 1/2	9545-060-001	1
6	Plate Assembly-Intermediate, Tension	9982-378-002	1
7	Rod-Intermediate, Pivot	9497-230-002	1
8	Collar, Locking	9076-060-001	1
9	Bolt, 1/2-13 x 1 1/2	9545-017-001	2
10	Thermostat-Overtemp	9576-207-006	1
11	Screw-10AB x 3/8	9545-008-006	2
*	Impeller, 5" x 16"	9278-041-001	1
12	Plate Assembly-Impeller	9982-375-002	1
13	Nut-Wiz Lock, 5/16-18	8640-400-003	6
*	Gasket-Impeller Housing	9206-428-002	1
14	Motor-Blower	9376-334-001	1
*	Run Capicator	5191-108-005	1
*	Start Capicator	5191-109-005	1
15	Screw, 5/16-18 x 5/8	9545-014-004	4
16	Nut-Wiz Lock, 5/16-18	8640-400-003	4
17	Motor, Drive	9376-307-003	1
18	Pulley-Motor	9453-169-012	1
*	Bushing, Motor -Support	9053-074-002	2
19	Rod-Motor Mounting, Black	9497-222-008	1
20	Collar-Shaft, w/Set Screws	9076-052-002	1
21	Chain-Belt tension	9099-012-004	1



7

8

6

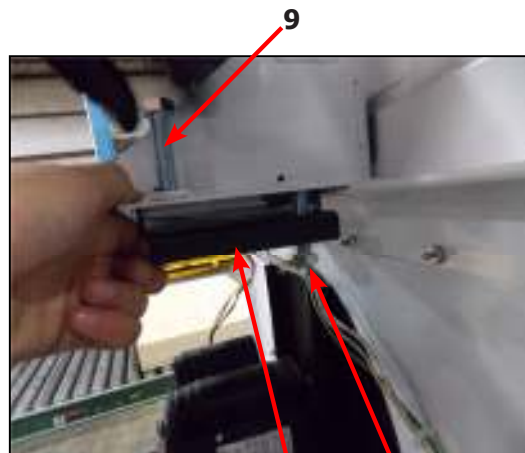

6

9

Dryer Rear View 120Lb Reversing Continued

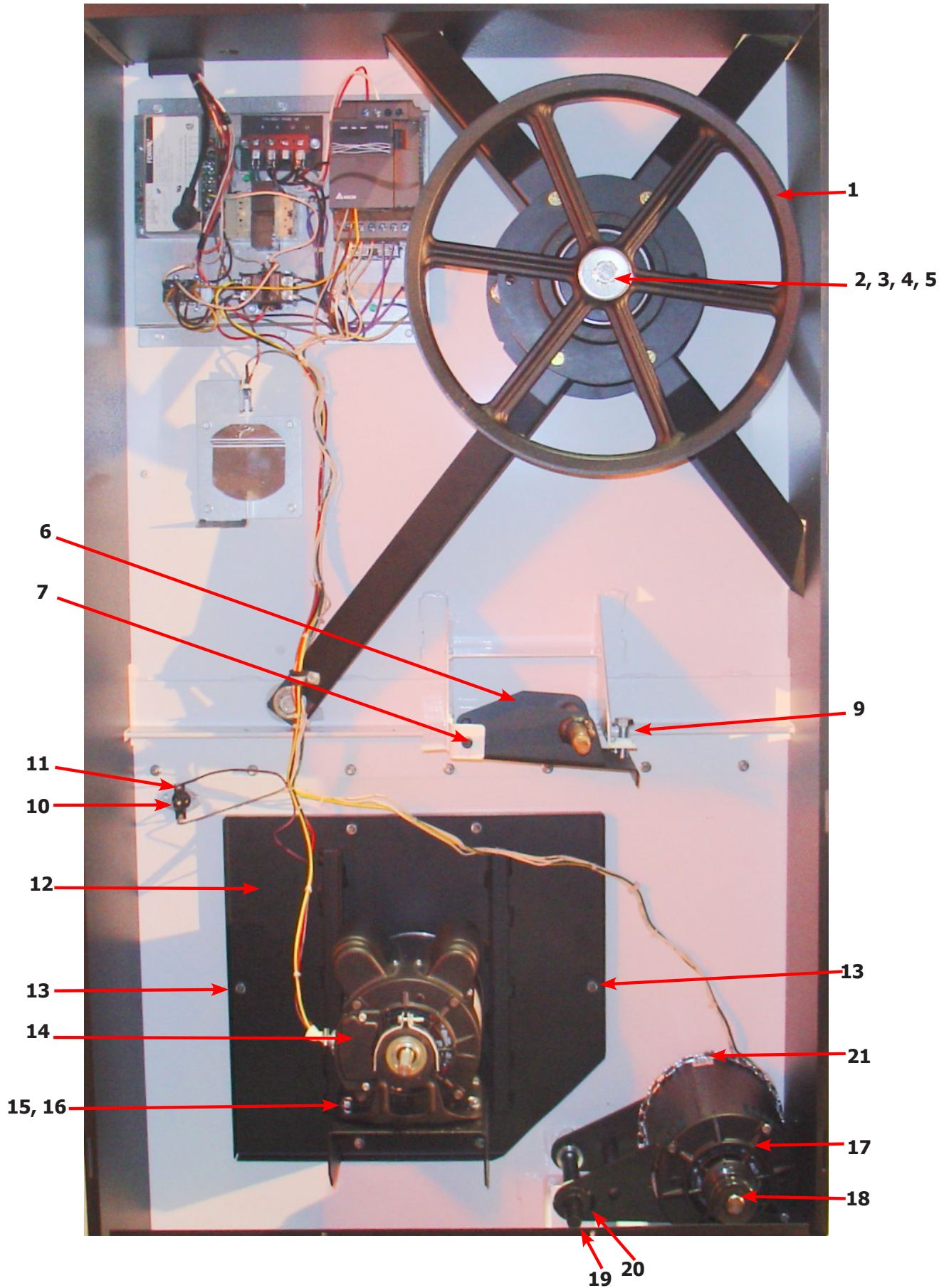

Dryer Rear View-Guard & Exhaust

Key	Description	T-120	QTY
1	Cover Cabinet	9074-356-001	1
*	Screw-5/16, 10ABx3/8	9545-008-024	10
2	Duct-Transition, 12" to 10"	9109-124-001	1
*	Screws-10-16 x 1/2	9545-008-003	3
*	Guard-Side, Right	9208-111-002	1
*	Screw-Torx T20, 10B x 3/8, BLK	9545-008-034	7
3	Guard-Side, Left	9208-110-002	1
*	Screw-Torx T20, 10B x 3/8, BLK	9545-008-034	8
4	Guard-Top	9208-112-002	1
*	Screw-Torx T20, 10B x 3/8, BLK	9545-008-034	11
5	Guard-Bottom	9208-113-002	1
*	Screw-Torx T20, 10B x 3/8, BLK	9545-008-034	6
6	Guard-Wires	9208-115-002	1
*	Screw-Torx T20, 10B x 3/8, BLK	9545-008-034	2
7	Guard-Door, Right	9208-114-004	1
*	Screw-Torx T20, 10B x 3/8, BLK	9545-008-034	6
8	Guard-Door, Left	9208-114-003	1
9	Screw-Torx T20, 10B x 3/8, BLK	9545-008-034	4
*	Nut-Spring, U-type	8640-399-001	4
*	Booklet-Owners	8514-234-001	1
10	Diagram & Schematics	9506-896-001	1
11	Label-Warning & Notice	8502-763-001	1
12	Label-Instructions	8502-645-001	1
13	Decal-Lighting & Clearance	8527-151-001	1
14	Label-High Voltage	8502-614-004	1

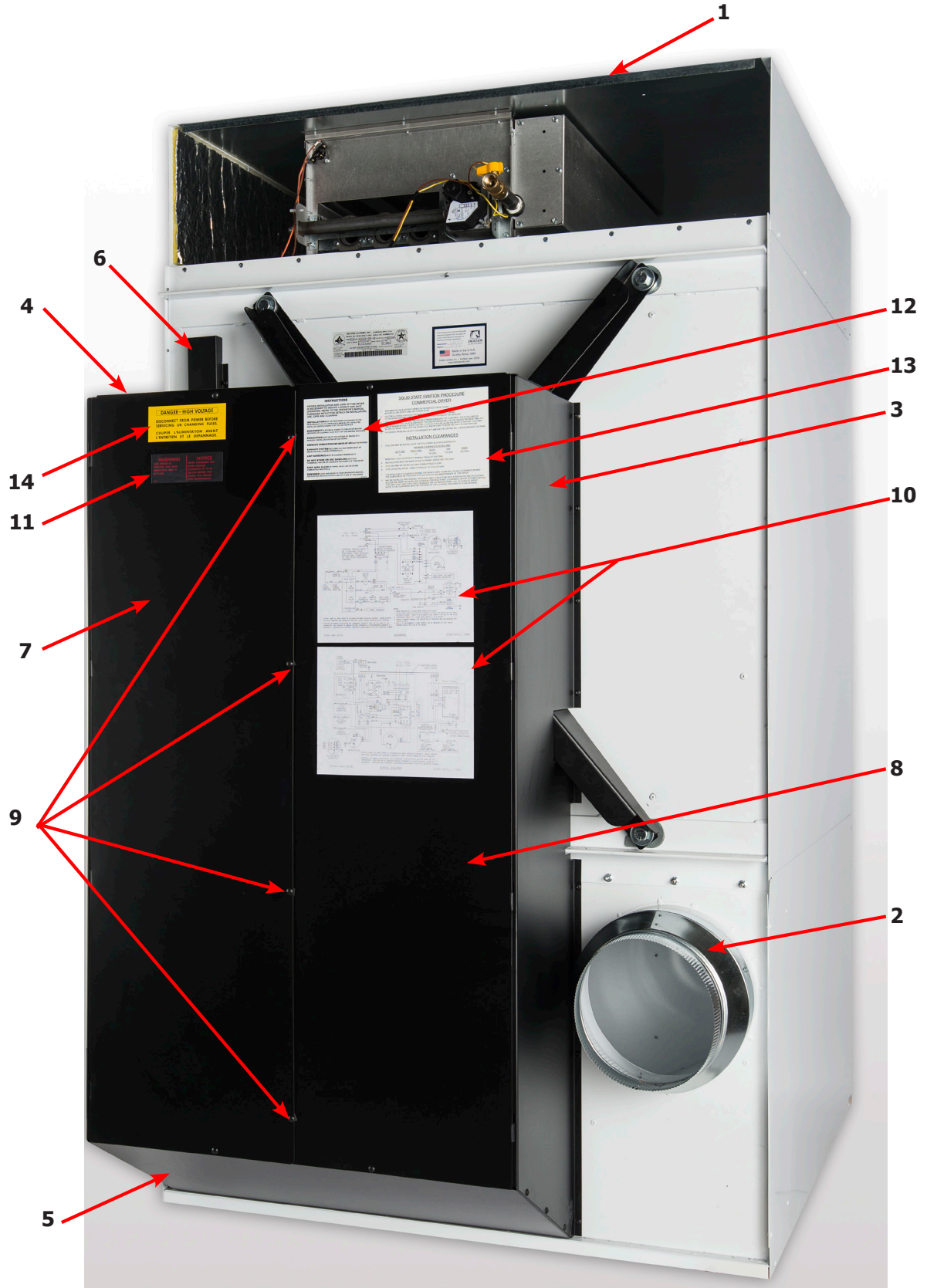

Dryer Rear View-Bearing Housing 120Lb

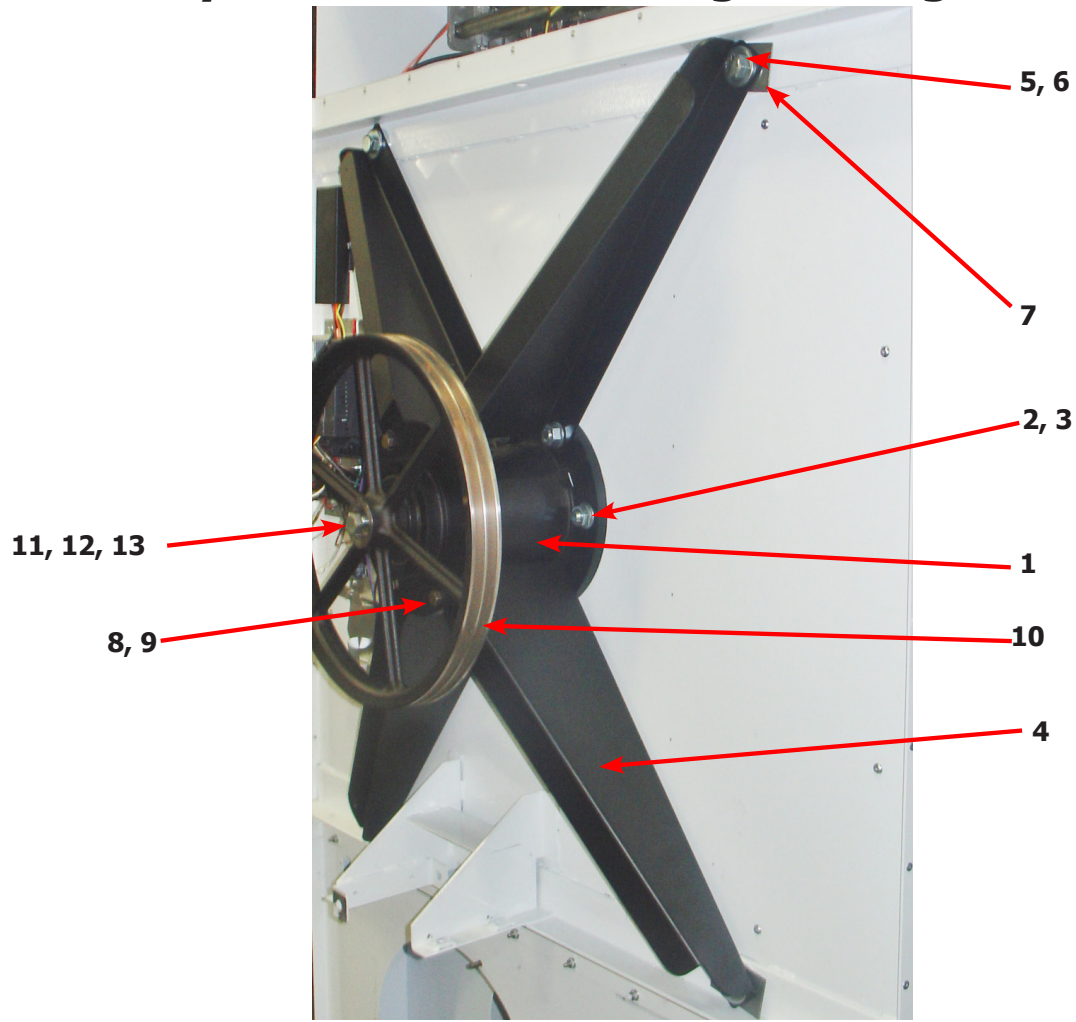

Key	Description	T-120	QTY
	Bearing Housing Complete Assy (Includes bearings & Spacer)	9803-186-001	1
1	Housing, Bearing	9241-180-002	1
*	Ring, Retaining-Internal	9487-238-003	1
*	Bearing, Ball, Front	9036-159-005	1
*	Spacer, Bearing	9538-167-001	1
*	Bearing, Ball, Rear	9036-159-004	1
*	Washer, Flat	8641-581-040	6
2	Screw-5/8"-11 x 1 1/2"	9545-060-001	6
3	Nut-Whizlock, 5/8" x 11	8640-425-001	6
4	Arm-Support Housing	9001-065-002	4
5	Screw-5/8-11 x 1 1/2	9545-060-001	4
6	Washer, Flat 5/8"	8641-581-038	4
7	Shim	9552-045-001	AR
8	Screw-7/16"-14 x 1 1/2"	9545-059-003	4
9	Nut-Whizlock, 7/16"	8640-416-005	4
*	Tolerance Ring	9487-234-006	1
10	Pulley Driven	9453-168-003	1
11	Washer, Flat 5/8" x 2 1/4"	8641-581-032	1
12	Lock Washer Spring, 1/2	8641-582-018	1
13	Screw, 5/8-11 x 1 1/2"	9545-060-001	1

Dryer Tumbler Group 120Lb

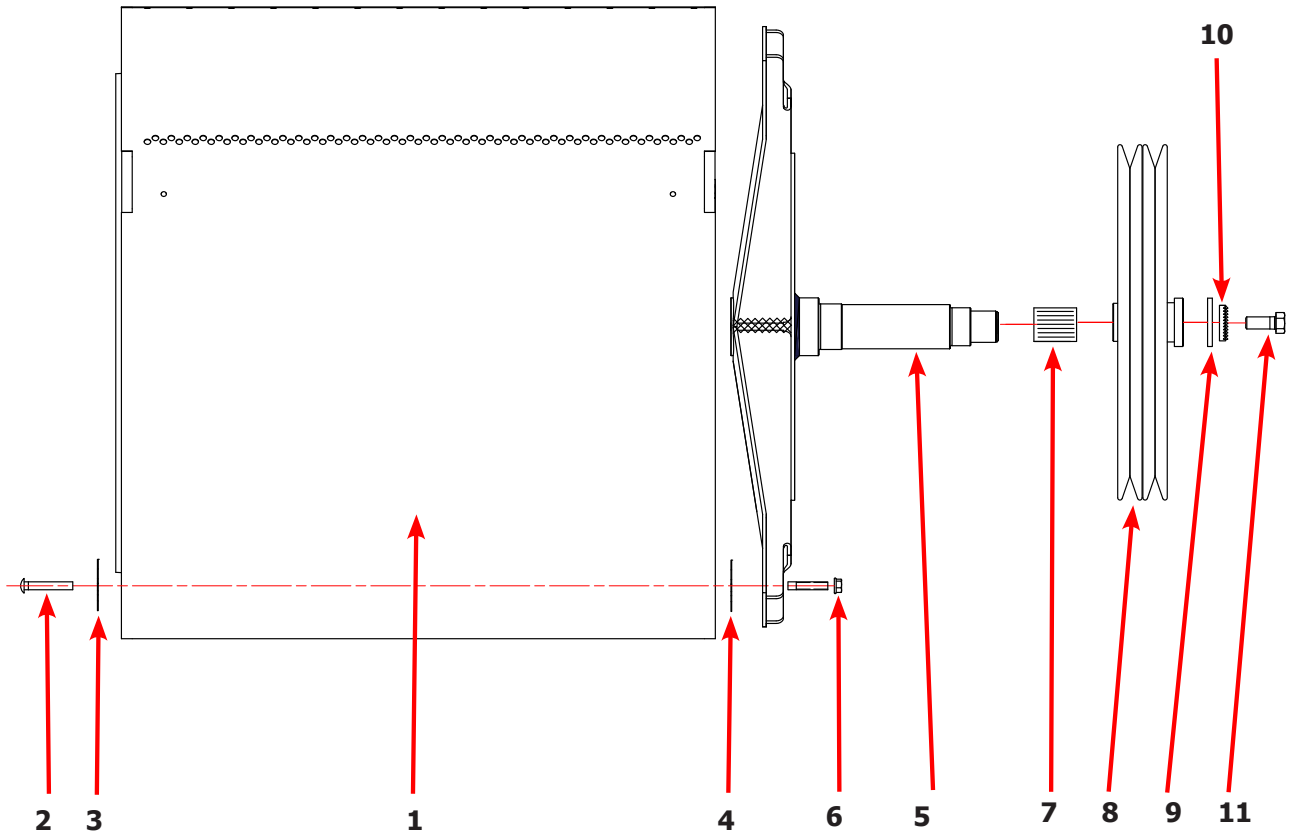

Key	Description	T-120	QTY
*	Tumbler Assy Complete W/Spider (GALV)	9848-160-001	1
1	Tumbler Assy (Galvanized)	9849-159-001	1
2	Rod, Tumbler	9497-266-003	4
3	Plate support, Tie Rod	9452-805-001	4
4	Shim	9552-013-003	AR
5	Spider Assy	9568-016-001	1
6	Nut, Wiz Lock	8640-417-005	4
7	Tolerance Ring	9487-234-006	1
8	Pulley, Driven	9453-168-003	1
9	Washer -Flat	8641-581-032	1
10	LockWasher - IntTooth, 1"	8641-582-018	1
11	Screw, 5/8-11 x 1 1/2	9545-060-001	1

Dryer Burner Housing Group 120Lb

Key	Description	T-120	QTY
*	Housing Assembly, Burner	9803-213-001	1
1	Screw, 10ABx3/8	9545-008-024	58
2	Bracket-Support, Gas Valve	9029-240-001	1
3	Side-Extension Baffle, Burner Housing	9551-049-001	2
4	Burner, Main	9048-022-001	3
5	Baffle-Burner Housing, Extension	9049-105-001	1
6	Panel-Burner Housing, Front	9454-882-001	1
7	Panel-Burner Housing, Back	9454-883-001	1
8	Panel-Burner Housing, Side Left	9551-052-001	1
9	Baffle-Center, Burner	9049-106-001	1
10	Panel-Burner Housing, Side Right	9551-051-001	1
11	Channel-Burner Housing, Right	9081-164-001	1
12	Bracket-Manifold	9029-239-001	1
13	Bracket-Support, Burner, Front	9029-241-001	1
14	Bracket-Support, Burner, Rear	9029-242-001	1
15	Control Assy,Gas Valve, White Rodgers 36J	9857-193-001	1
16	Manifold Assy	9381-013-001	1
17	Top Assembly, Burner Housing	9961-161-001	1
18	Screw, 10Bx1/4	9545-008-001	18
*	Orfice-Natural, #10	9425-069-027	3
*	Orfice-LP, #32	9425-069-009	3
*	Kit, LP Conversion, White Rodgers	9732-102-025	1
19	Thermostat-HI-Limit	9576-203-002	1
20	Electrode-Ignition	9875-002-003	1
21	Bracket-Igniter	9029-243-001	1
22	Elbow-3/4 Street, Black	8615-104-042	1
23	Pipe-Nipple, 3/4 x 4", Black	8655-073-046	
24	Valve-Gas Shutoff,	9379-198-001	1
25	Deflector-bottom,air	9114-055-001	1

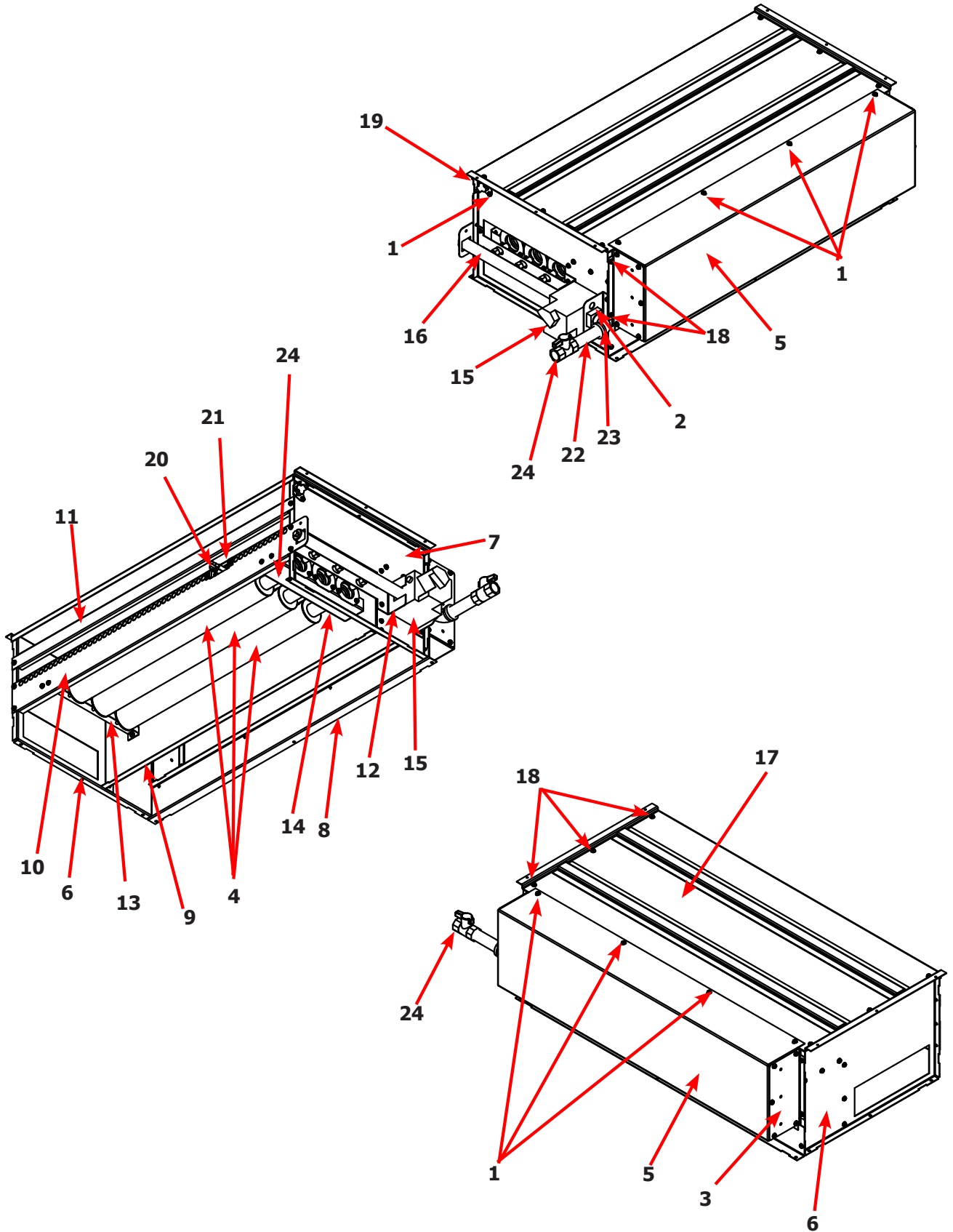

Dryer Air Flow Switch Assembly

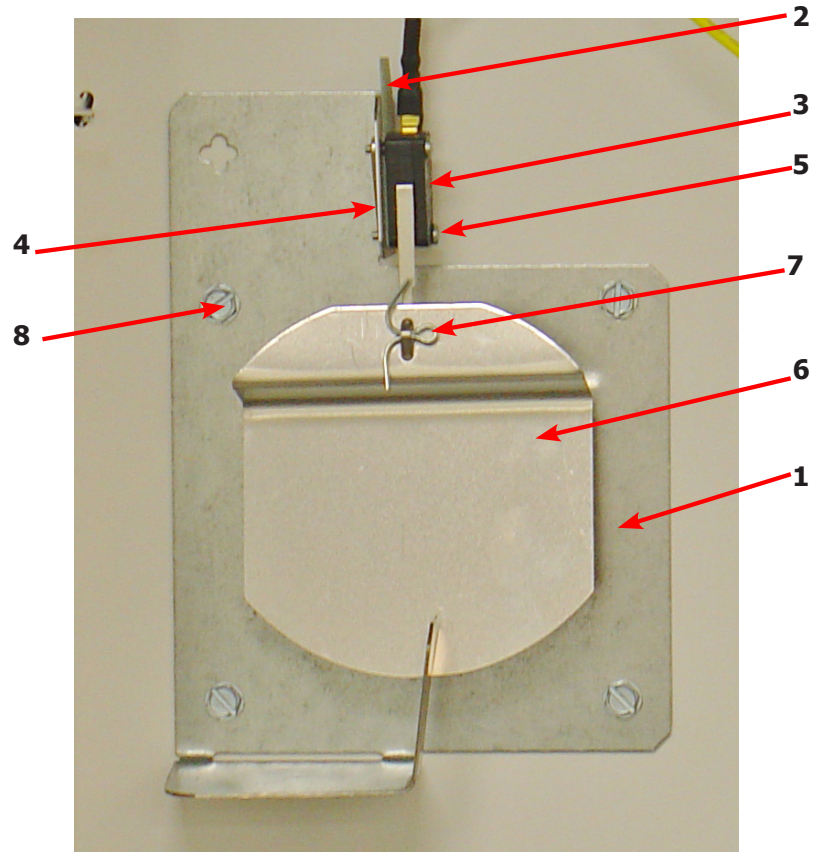

Key	Description	T-120	QTY
*	Air Flow switch Assy	9801-098-001	1
1	Bracket-Airflow switch	9029-200-001	1
2	Shield-Switch	9550-169-003	1
3	Switch-Micro	9539-461-009	1
4	Nut-Twin, 4-40	8640-401-001	1
5	Screw-.625, 4-40	9545-020-001	2
6	Actuator-Air Flow Switch	9008-007-001	1
7	Pin-Cotter, .09375x.75	9451-169-002	1
8	Screw, 10Bx1/4	9545-008-024	4

Dryer Coin Switch Assembly

Key	Description	T-120	QTY
1	Optical Coin Acceptor	9021-041-001	1
2	Replacement Optical Sensor	9801-099-003	1
3	Retainer-Coin Acceptor	9486-149-001	2
4	Screws-Torq, 4Bx5/8 ss	9545-053-002	4

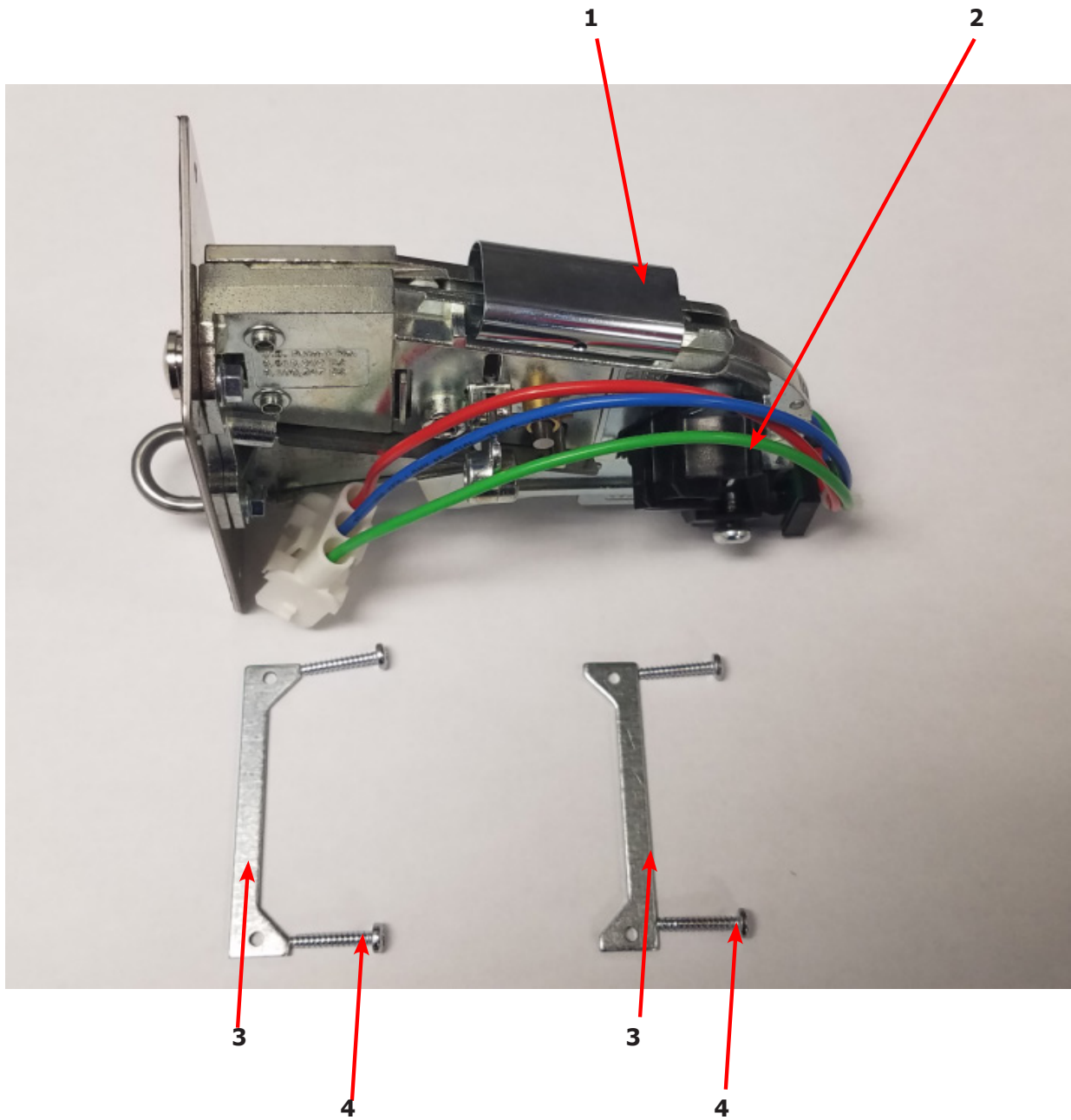

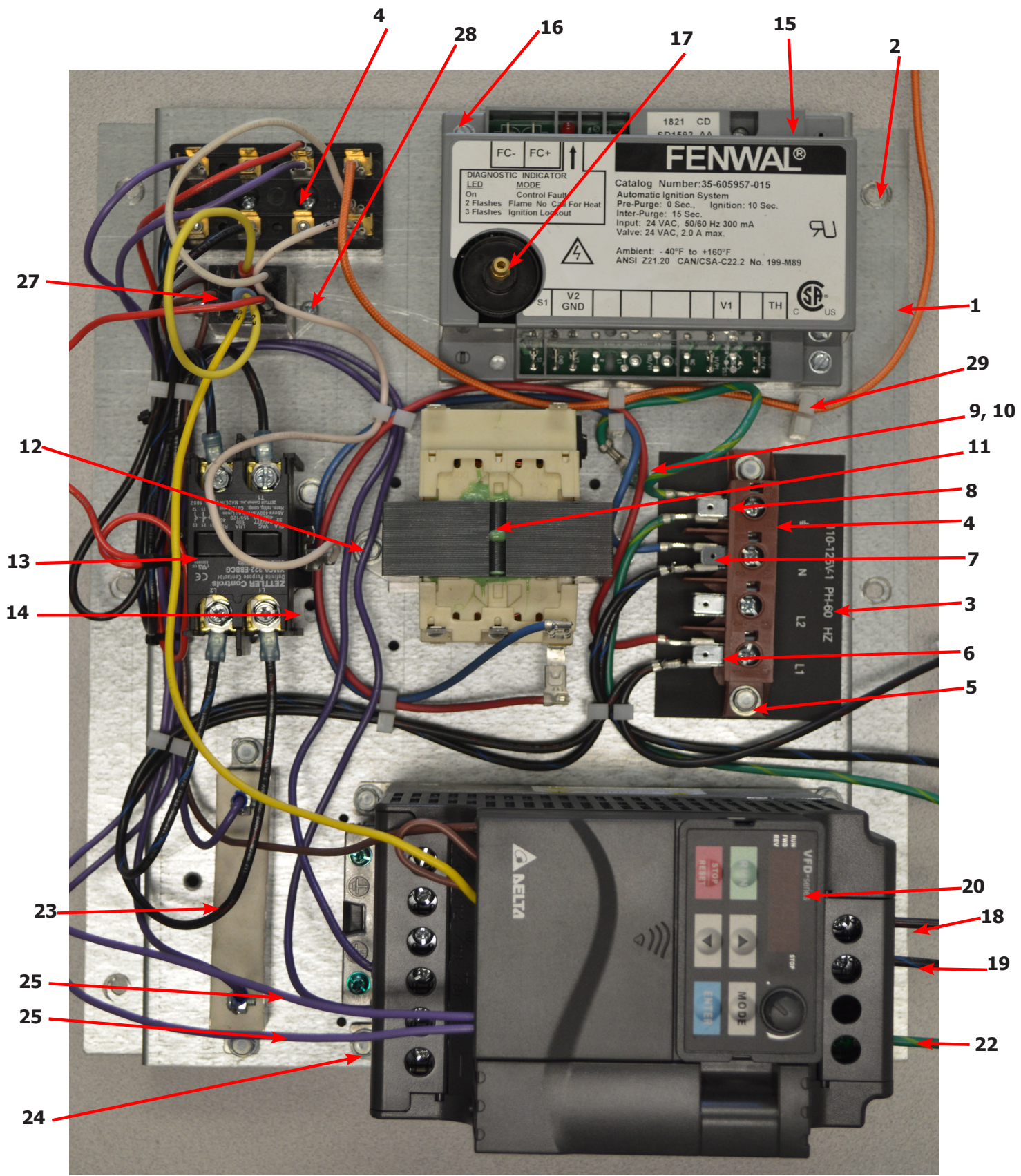

Dryer Rear View-Control Box

Key	Description	T-120	QTY
*	Cntlasy-cmpl,t-120coin,60hz	9857-261-001	1
1	Channel-Controls	9081-163-001	1
2	Screw, 5/16-10AB-3/8	9545-008-026	6
3	Strip-Marker, Terminal	9558-029-005	1
4	Terminal Block Assy-Power, 4Pole	9897-035-001	1
5	Screw, 5/16-10AB-3/8	9545-008-024	2
6	Wireasy-blk/red, 15.5"	8220-095-051	1
7	Wireasy-blk/blu, 15.5"	8220-095-052	1
8	Wireasy-grn/ylw, 7'	8220-137-002	1
9	Screw- 10-32TTx1/2 GRN	9545-008-027	2
10	Lockwasher, External tooth	8641-582-006	2
11	Transformer, w/Circuit breaker	8711-007-002	1
12	Screw, 5/16-10AB-3/8	9545-008-024	2
13	Relay-Motor, 30Amp, 24VAC	5192-299-002	1
14	Screw, 5/16-10AB-3/8	9545-008-024	2
*	Wire assy-Blk/Red, 15"	8220-146-003	2
*	Wire assy-Blk/Blu, 15"	8220-146-004	2
15	Control Assy, Ignition (Module)	9857-182-001	1
16	Screw-8Bx3/4"	9545-045-005	2
*	Harness, Ignition Module	9627-867-004	1
17	Wire Assy- High Voltage Lead	9631-403-005	1
18	Wire Assy-Jumper.red16-9"	8220-097-004	1
19	Wire Assy-White, 12"		1
20	Drive-vf,deltae,t-120, coin	9375-031-008	1
PS	Key Pad, Delta E-Drive	9150-044-001	1
21	Screw-#10B x 1/2	9545-008-026	4
22	Wire Assy-Green, 18"	8220-092-006	1
*	Wire Assy, Brown 3"	8220-057-035	1
23	Resistor-Dynamic Breaking, 200OHM	9483-004-002	1
24	Screw-5/16, 10ABx3/8	9545-008-024	2
25	Wire Assy, Violet 8"	8220-118-003	2
			1
27	Relay, 24VAC	5192-285-004	1
28	Screw, 6B x 3/8		4
*	Wire Assy-BLK/BLU, 15"	8220-150-002	1
*	Wire Assy-BLK/RED, 12"	8220-150-001	1
*	Harness, Control	9627-859-005	1
29	Stand off	9527-007-002	7

Wiring Diagram for 60hz Dryer -10BD

9506-896-001PR

WIRING DIAGRAM

DC0120N_10_C_R

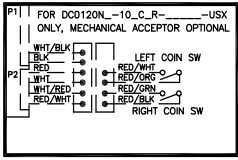
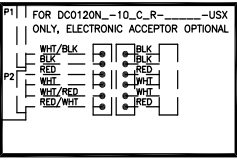
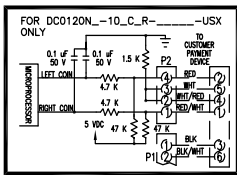
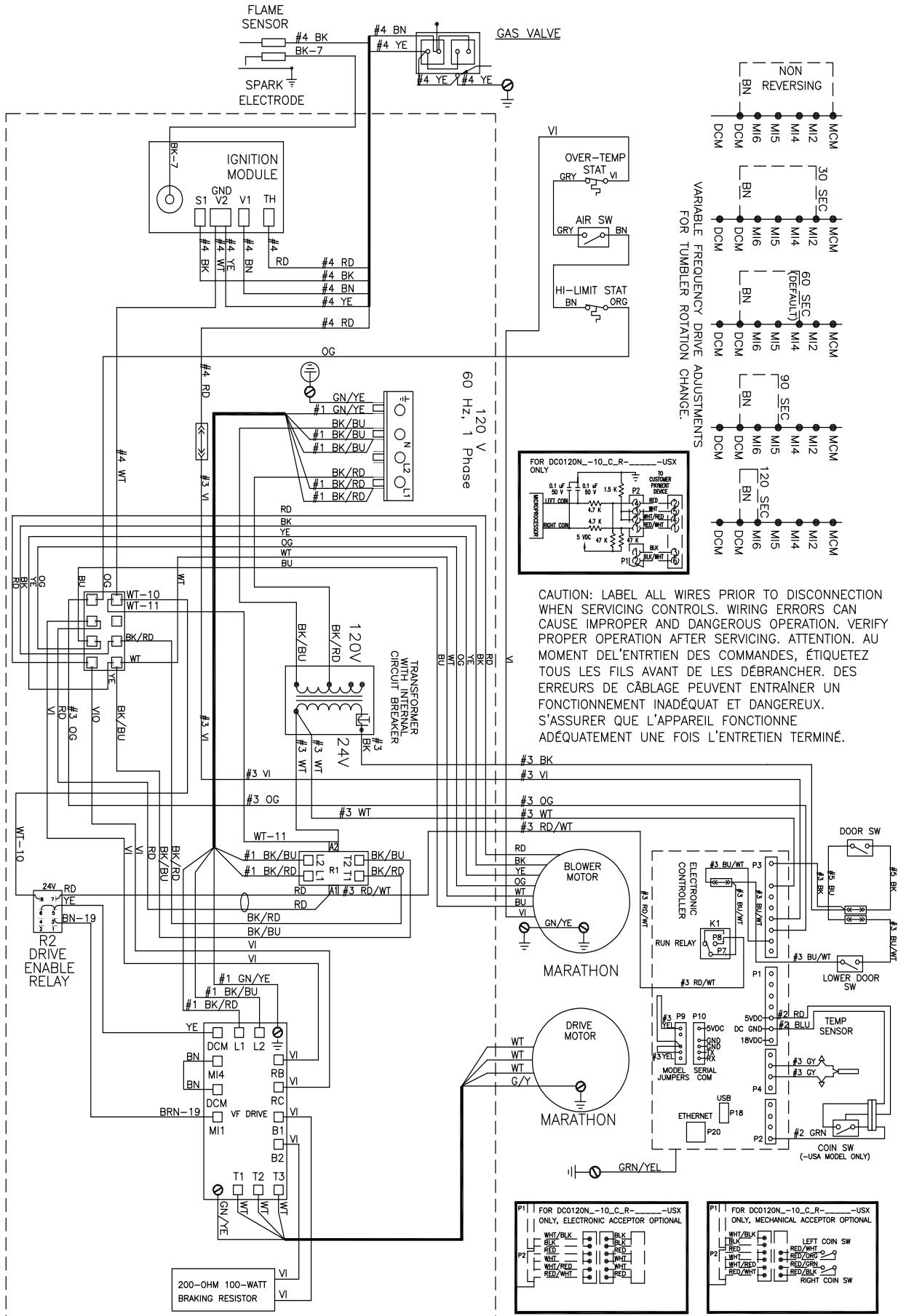

Wiring Schematic for 60hz Dryer -10BD

CAUTION: LABEL ALL WIRES PRIOR TO DISCONNECTION WHEN SERVICING CONTROLS. WIRING ERRORS CAN CAUSE IMPROPER AND DANGEROUS OPERATION. VERIFY PROPER OPERATION AFTER SERVICING.

ATTENTION: AU MOMENT DEL'ENTRIEN DES COMMANDES, ETIQUETEZ TOUS LES FILS AVANT DE LES DEBRANCHER. DES ERREURS DE CABLAGE PEUVENT ENTRAINER UN FONCTIONNEMENT INADEQUAT ET DANGEREUX. S'ASSURER QUE L'APPAREIL FONCTIONNE ADEQUATEMENT UNE FOIS L'ENTRIEN TERMINE.

IMPORTANT: RETAIN THIS ELECTRICAL SCHEMATIC FOR SERVICE.

9506-896-001PR

SCHEMATIC

DC0120N_10_C_R

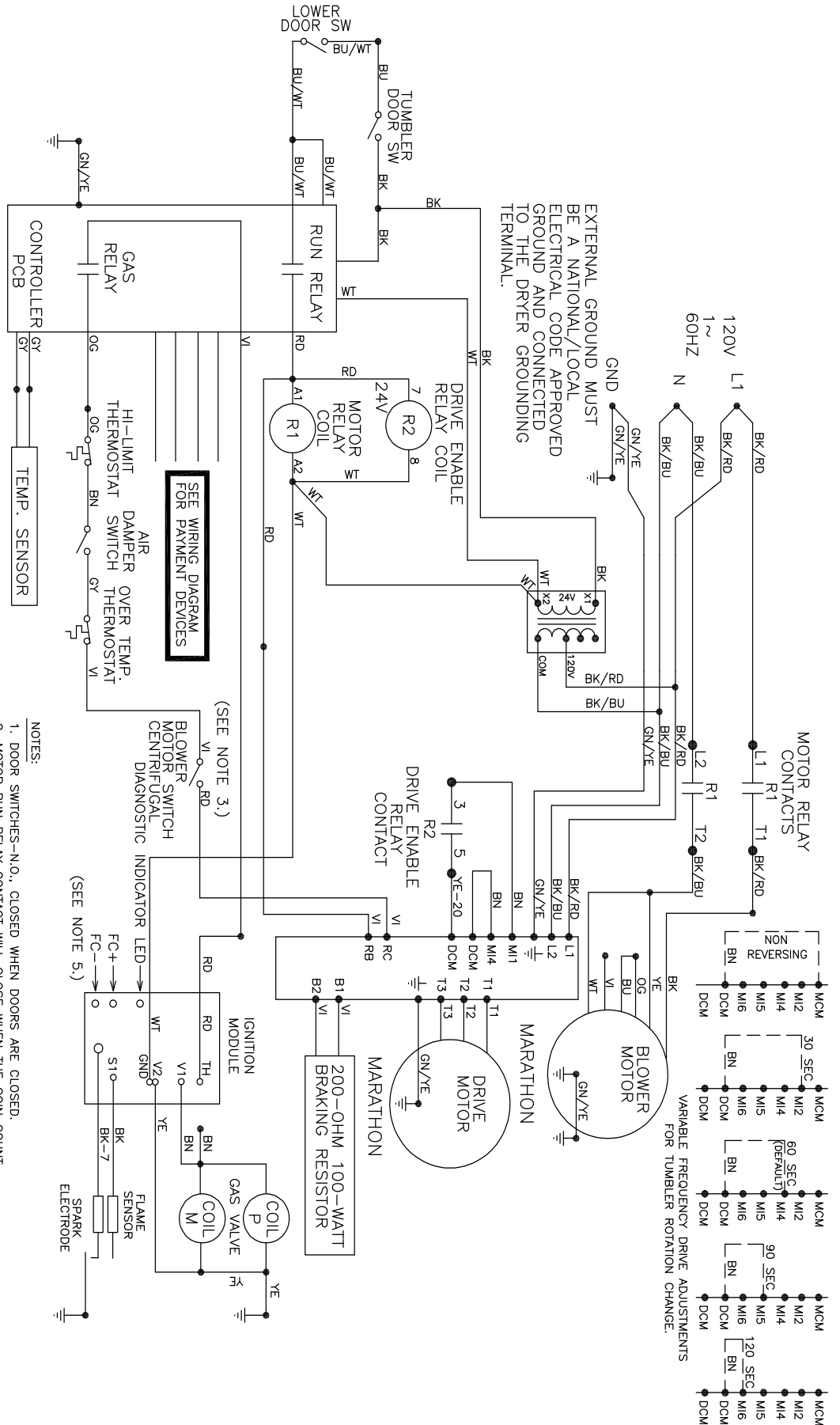



Section 6:

Maintenance Schedule

Preventative Maintenance

Daily

- Step 1:** Clean the lint screen free of lint and other debris. Use a soft brush and Hot water if necessary.
- Step 2:** Check the lint screen for tears. Replace if necessary.
- Step 3:** Clean lint from the lint screen compartment.
- Step 4:** Inspect felt seal on lint screen assembly, replace if needed.

Monthly

- Step 1:** Remove lint accumulation from the end bells of the motor.
- Step 2:** Remove lint accumulation from front control area.
- Step 3:** Remove lint and dirt accumulation from the top of the dryer and all areas above, below, and around the burners and burner housing. Failure to keep this portion of the dryer clean can lead to a build-up of lint creating a fire hazard.
- Step 4:** Remove and clean coin acceptors. (Vended Models Only)

Quarterly

- Step 1:** Check the belts for looseness, wear, or fraying.
- Step 2:** Inspect the gasket of the door glass for excessive wear.
- Step 3:** Check tightness of all fasteners holding parts to support channel.
- Step 4:** Check tightness of all set screws.
- Step 5:** Remove the air flow switch assembly and check the tumbler thru-bolts for tightness.
- Step 6:** Apply a few drops of oil to pivot pins and the tension arms where in contact with each other.

Semi-Annually

- Step 1:** Remove and clean the main burners.
- Step 2:** Remove all orifices and examine for dirt and hole obstruction.
- Step 3:** Remove all lint accumulation. Remove the front panel and the lint screen housing and remove lint accumulation.

Annually

- Step 1:** Check the intermediate pulley bearings for wear.
- Step 2:** Check and remove any lint accumulation from the exhaust system including recirculation chambers if applicable.
- Step 3:** Grease the bearings and the shaft of the intermediate pulley. Use an Alemite grease gun and Molykote BR2-S grease. (Where applicable)