

**INDUSTRIAL WASHER
MODEL T-650 EXPRESS ON-PREMISE
N-SERIES CONTROL – 50Hz**

**Original Instructions
For GB & IE**



**DEXTER.
LAUNDRY**

**OPERATOR'S MANUAL
INSTALLATION & OPERATION
INSTRUCTIONS**

Please read this information and retain for reference.

The washer will operate correctly in ambient temperatures of +5°C to +40°C, in relative humidity up to 50% at +40°C and above 50% when below +40°C, and at altitudes up to 1000m above sea level, must be transported and stored from -25°C to +55°C and up to +70°C for short periods of time, and has been packaged to prevent damage from humidity, vibration, and shock. Take measures to avoid harmful effects of occasional condensation.

WARNING - THIS WASHER IS EQUIPPED WITH DEVICES AND FEATURES RELATING TO ITS SAFE OPERATION. TO AVOID INJURY OR ELECTRICAL SHOCK, DO NOT PERFORM ANY SERVICING UNLESS QUALIFIED TO DO SO.

IT IS THE RESPONSIBILITY OF THE OWNER TO CHECK THIS EQUIPMENT ON A FREQUENT BASIS TO ASSURE ITS SAFE OPERATION.

A machine should NOT be allowed to operate if any of the following occur:

- Excessively high water level.
- If machine is not connected to a properly grounded circuit.
- If the door does not remain securely locked during the entire cycle.
- Vibration or shaking from an inadequate mounting or foundation.

WARNING - SAFETY PRECAUTIONS

- Always shut off power and water supply before servicing.
- Do not overload the washer.
- Do not open door when cylinder is in motion or it contains water.
- Do not bypass any safety devices of this washer.
- Do not use volatile or flammable substances in or near this washer.
- Bleach is corrosive and use may cause component failure under certain circumstances.
- Keep all panels in place. They protect against shock and injury and add rigidity to the washer.

This appliance can be used by children aged from 8 years and above and persons with reduced physical, sensory or mental capabilities or lack of experience and knowledge if they have been given supervision or instruction concerning use of the appliance in a safe way and understand the hazards involved. Children shall not play with the appliance. Cleaning and user maintenance shall not be made by children without supervision. Children of less than 3 years should be kept away unless continuously supervised.

PREVENTIVE MAINTENANCE REQUIREMENTS

DAILY - Leave all panels in place while performing these steps.

- Check that the loading door remains securely locked and cannot be opened during an entire cycle.
- Check the water connections for leaks.
- Clean the top, front, and sides of the cabinet to remove residue.
- Clean the soap dispenser and lid and check that all dispenser mounting screws are in-place and tight.
- Check the drain valve for leaking and that it opens properly.
- Check the loading door for leaks. Clean the door seal of all foreign matter.
- Leave the loading door open to aerate the washer when not in use.

QUARTERLY - Apply proper lock out tag out procedures before performing these steps.

- Make sure the washer is inoperative by switching off the main power supply.
- Check the V-belts for wear and proper tension.
- Clean lint and other foreign matter from around motor and variable frequency drive.
- Check all water connections for leaks.
- Wipe and clean the inside of the washer and check that all electrical components are free of moisture and dust.
- Remove and clean water inlet hose filters. Replace if necessary.
- Check anchor bolts. Retighten if necessary.





















IMPORTANT: Replace any and all panels that were removed to perform daily and/or quarterly maintenance.





TABLE OF CONTENTS

1	INSTALLATION INSTRUCTIONS	4
1.1	UNCRATING INSTRUCTIONS	4
1.2	FOUNDATION REQUIREMENTS	4
1.3	MOUNTING	4
1.4	PLUMBING	8
1.5	DRAIN	8
1.6	PROTECTIVE FILM.....	8
1.7	ELECTRICAL.....	8
1.8	INJECTION SOURCE CONNECTIONS.....	11
1.9	OPERATION CHECK.....	11
2	OPERATING INSTRUCTIONS.....	13
2.1	CONTROL BUTTONS.....	13
2.2	STARTING THE WASHER	13
2.3	OPTIONAL SOAK	14
2.4	END OF CYCLE	15
2.5	EMERGENCY STOP / SAFETY DOOR LOCK.....	15
2.6	VARIABLE FREQUENCY DRIVE INDICATORS	15
3	MACHINE PROGRAMMING INSTRUCTIONS	16
3.1	EDITING AN EXISTING CYCLE.....	16
3.2	PROGRAMMING A NEW CYCLE.....	18
3.3	DEFAULT WASHER CYCLE PROGRAMS.....	18
3.4	RAPID ADVANCE MODE	31
3.5	DIAGNOSTIC TEST CYCLE.....	32
3.6	WATER LEVEL ADJUSTMENT.....	34
4	TROUBLESHOOTING	35
5	SERVICE AND PARTS	41

MODEL	T-650 18.2 kg (40 LB.) EXPRESS WASHER
WASHER NET WEIGHT	347.5 kg (766 LBS)
CAPACITY	18.2 kg/170L (40 LBS/6 CUBIC FT.)
CYLINDER SIZE	63.5 cm DIA x 53.7 cm DEEP (25" DIA X 21 1/8" DEEP)
ELECTRICAL	230 VAC, 50 HZ, 1 PHASE; OR 400 VAC, 50 HZ, 3 PHASE (ELECTRIC HEAT MODEL)
DRIVE SYSTEM	SOFT START REVERSING INVERTER DRIVE, 2 HP MOTOR
WASH SPEED	50 RPM
INTERMEDIATE EXTRACT	411 RPM (60 G'S)
FINAL EXTRACT	750 RPM (200 G'S)
MACHINE CONTROL	PROGRAMMABLE COMPUTER UP TO 30 CYCLES
WATER INLET	2 SOLENOID OPERATED VALVES - FLOW RATE: 35L/MIN (9 GAL/MIN) EACH, 207-827 kPa (30-120 PSI)
DRAIN VALVE	76 mm (3") DIAMETER

Table 1: Washer Specifications

 	Caution! There are sharp edges on various sheet metal parts internal to the enclosure. Use safety consciousness when placing or moving your hands while working in the interior of this equipment.		
	Meaning: Do Not Enter This Equipment (or Space).		Meaning: Do Not Step, Stand, or Sit on This Equipment.
	Meaning: Do Not Operate with Guards or Covers Removed.		Meaning: High Voltage. Disconnect power before servicing.
	Meaning: Disconnect Power Before Servicing Equipment.		Meaning: Disconnect Water Supply Before Servicing Equipment.
	Meaning: Lock Out and Tag Out before servicing.		Meaning: Burn Hazard. Do Not Touch Door Glass or Soap Compartments. Allow these parts to cool before servicing.
	Meaning: Do Not Wash Items Containing Explosive Material.		Meaning: Do Not Wash Items Containing Flammable Material.
	Meaning: Read Operators Manual.		Meaning: Do Not Supply Inlet Water > 88°C to the Water Inlet Valve to Reduce the Risk of Damage.
	Meaning: Do Not Operate in Any Hazardous Classified (ATEX) Environment.		Meaning: Do Not Operate if Door Glass is Damaged in Any Way.
	Meaning: Left Point for Forklift or Hand Pallet Truck or Jack.		Meaning: Right Point for Forklift or Hand Pallet Truck or Jack.
	Meaning: Do Not Allow Children to Play in or Around Equipment.		Meaning: Supervise Children to ensure They Do Not Operate Equipment.

Misuse of Washer	
	Do not use this Equipment for any purpose not described in this Manual.
	Do not operate this equipment without all guards and covers in place.
	Do not operate this washer from any power source not matching the operational requirements on the back of the washer.
	Do not place your body inside the washer cylinder or allow others to do so. Death or serious injury can result from this!
Other Examples May Be Applicable	

1 INSTALLATION INSTRUCTIONS

All washers must be installed in accordance with all local, state and national building, electrical, plumbing and other codes in effect in the area.

WARNING:

THESE INSTALLATION AND SERVICING INSTRUCTIONS ARE FOR USE BY QUALIFIED PERSONNEL ONLY. TO AVOID INJURY AND ELECTRICAL SHOCK, DO NOT PERFORM ANY SERVICING OTHER THAN THAT CONTAINED IN THE OPERATING INSTRUCTIONS, UNLESS QUALIFIED.

1.1 UNCRATING INSTRUCTIONS

1. Use a knife or similar instrument to remove plastic wrap from the washer packaging.
2. Remove the cardboard pieces from the washer packaging.
3. Use a Phillips-Head screwdriver to remove the lower service door from the washer.
4. Use an 11/32" wrench or socket and ratchet to loosen the bottom three screws on the back panel and a 5/32" wrench or socket and ratchet to remove the remaining screws and back panel from the washer.
5. Use a 3/4" wrench and socket and ratchet to remove the four lag screws that attach the washer frame to the two wooden runners.
6. Use a forklift or pallet jack, at the front or back of the washer to remove the washer from the runners and to the mounting base or pedestal.

1.2 FOUNDATION REQUIREMENTS

This machine is designed for use on or over bare concrete floor - not to be used above combustible flooring. The washer must be securely bolted **and grouted** to a substantial concrete floor, or mounted **and grouted** upon a suitable base that is securely bolted **and grouted** to a substantial concrete floor.

CARE MUST BE STRESSED WITH ALL FOUNDATION WORK TO INSURE A STABLE UNIT INSTALLATION, ELIMINATING POSSIBILITIES OF EXCESSIVE VIBRATION.

All installations must be made on sound concrete floors, 203 mm (8 inches) or thicker. Anchor bolts or expansion anchors must be of a quality grade and a minimum of 19 mm (3/4-inch) diameter. Six bolts are required to mount the washer to the steel base or concrete pad. Mounting hardware is not provided with the machine.

1.3 MOUNTING

A concrete pedestal or steel-mounting base that elevates the machine approximately 102 mm (4 inches) above the floor level is recommended to provide easy access to the loading door. Allow a minimum of 610 mm (24 inches) of clearance behind the rear of the machine, to provide access for motor removal. Refer to Figure 1-1 and Figure 1-2 for machine bolt-down dimensions. Contact a Dexter laundry equipment distributor for recommended steel mounting bases.

If an elevated concrete pedestal is desired, it should be embedded into the existing floor. Anchor bolts should be 19 mm x 200 mm (3/4" x 8"), grade 8 or better, headed by a 10 mm (4 inch) square fish plate and should protrude 64 mm (2 1/2") above the finished surface of the pedestal.

EXPANSION ANCHORS ARE NOT RECOMMENDED FOR USE IN CONCRETE PEDESTALS, BECAUSE THE ANCHORS ARE TOO CLOSE TO AN EDGE, CAUSING IT TO BREAK OUT.

Refer to Figure 1-1 and Figure 1-3 for recommended concrete pedestal dimensions. Refer to **Error! Reference source not found.** for overall machine mounting

dimensions.

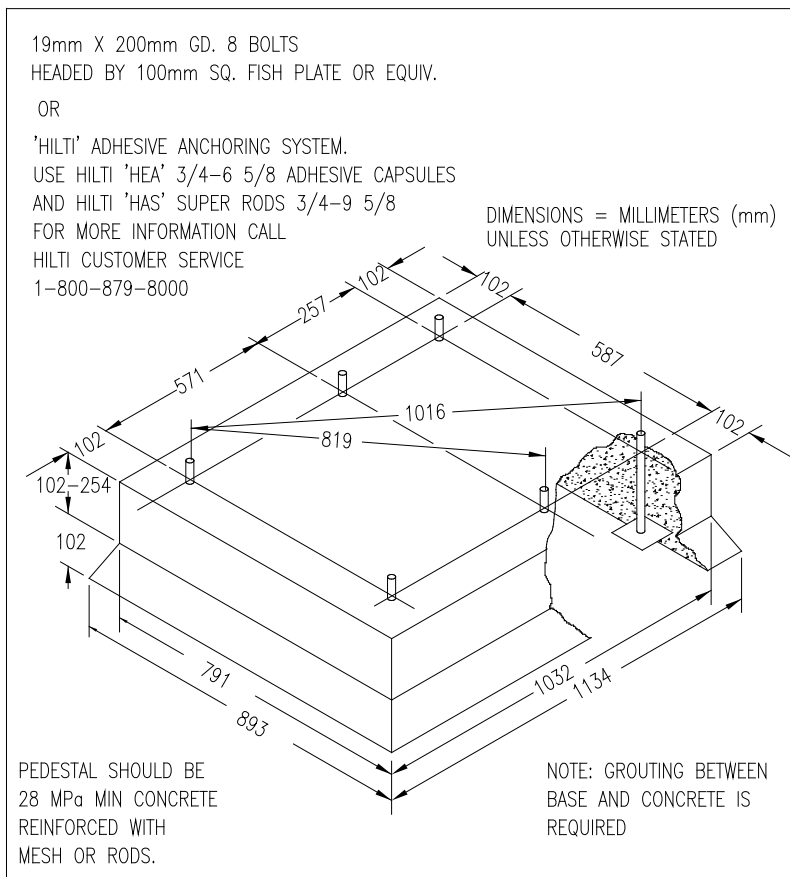

Figure 1-1: Concrete Pedestal Mounting (metric)

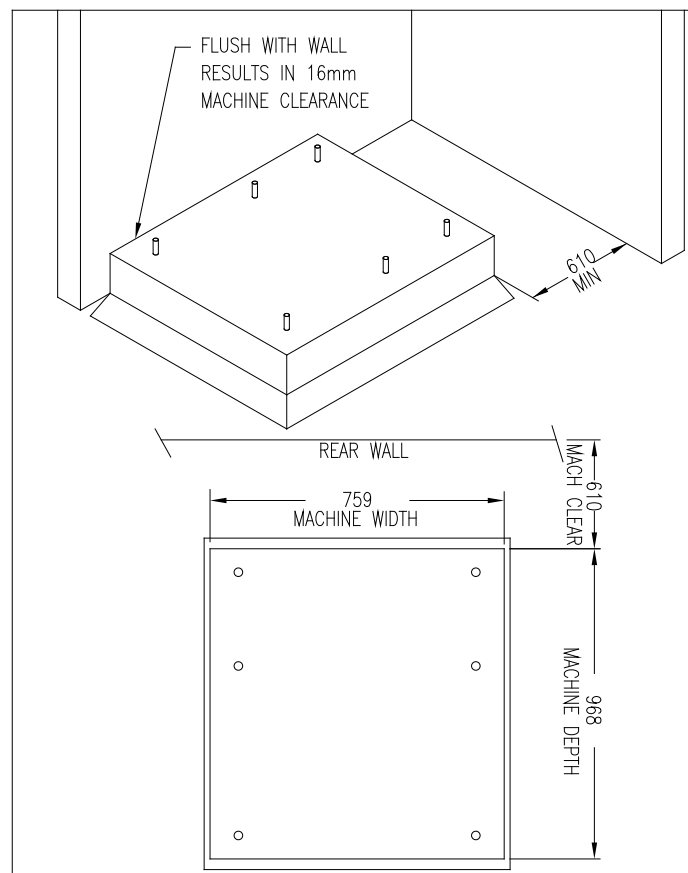

Figure 1-2: Floor Outline (metric)

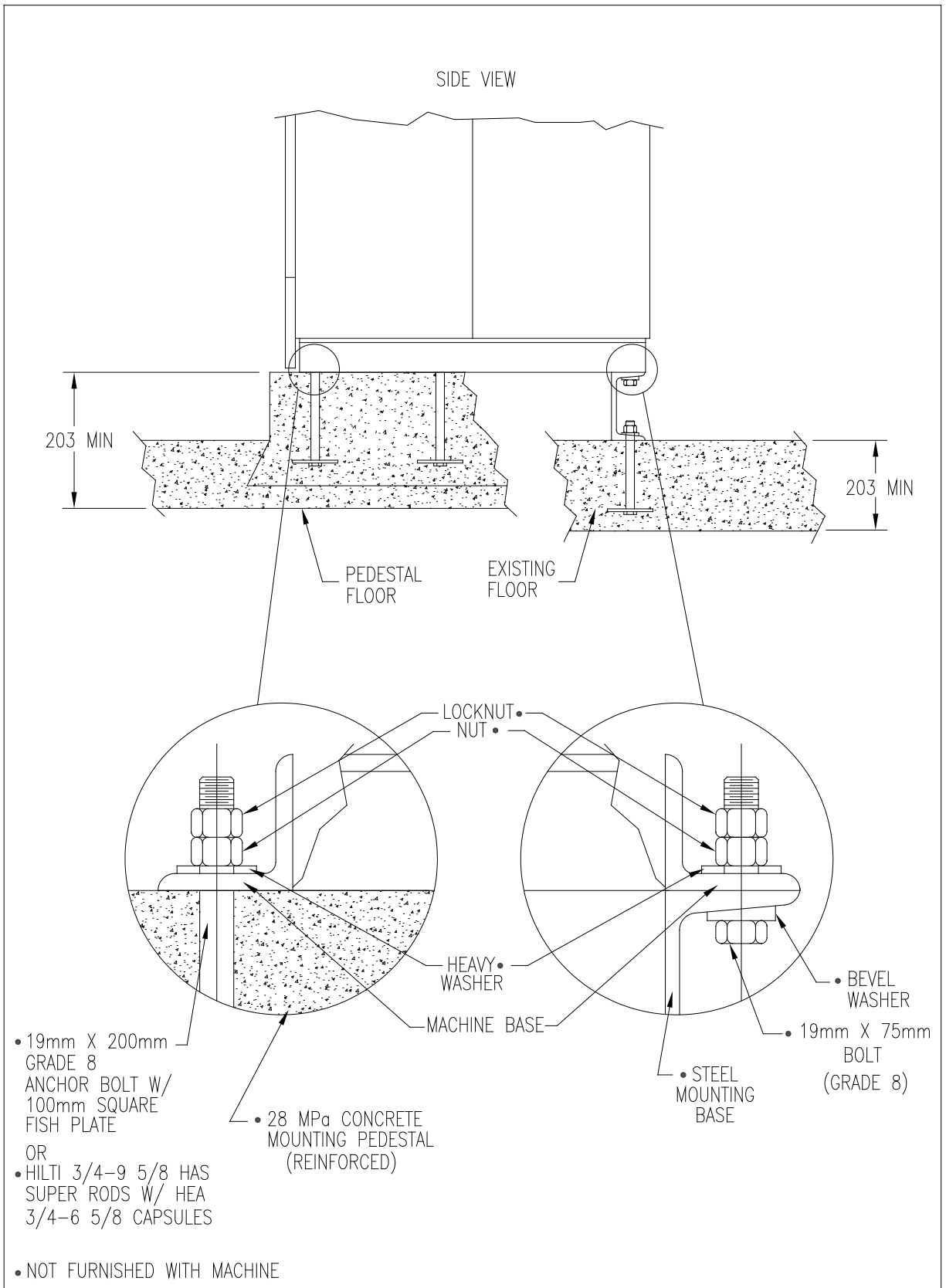

Figure 1-3: Machine Mounting Detail (metric)

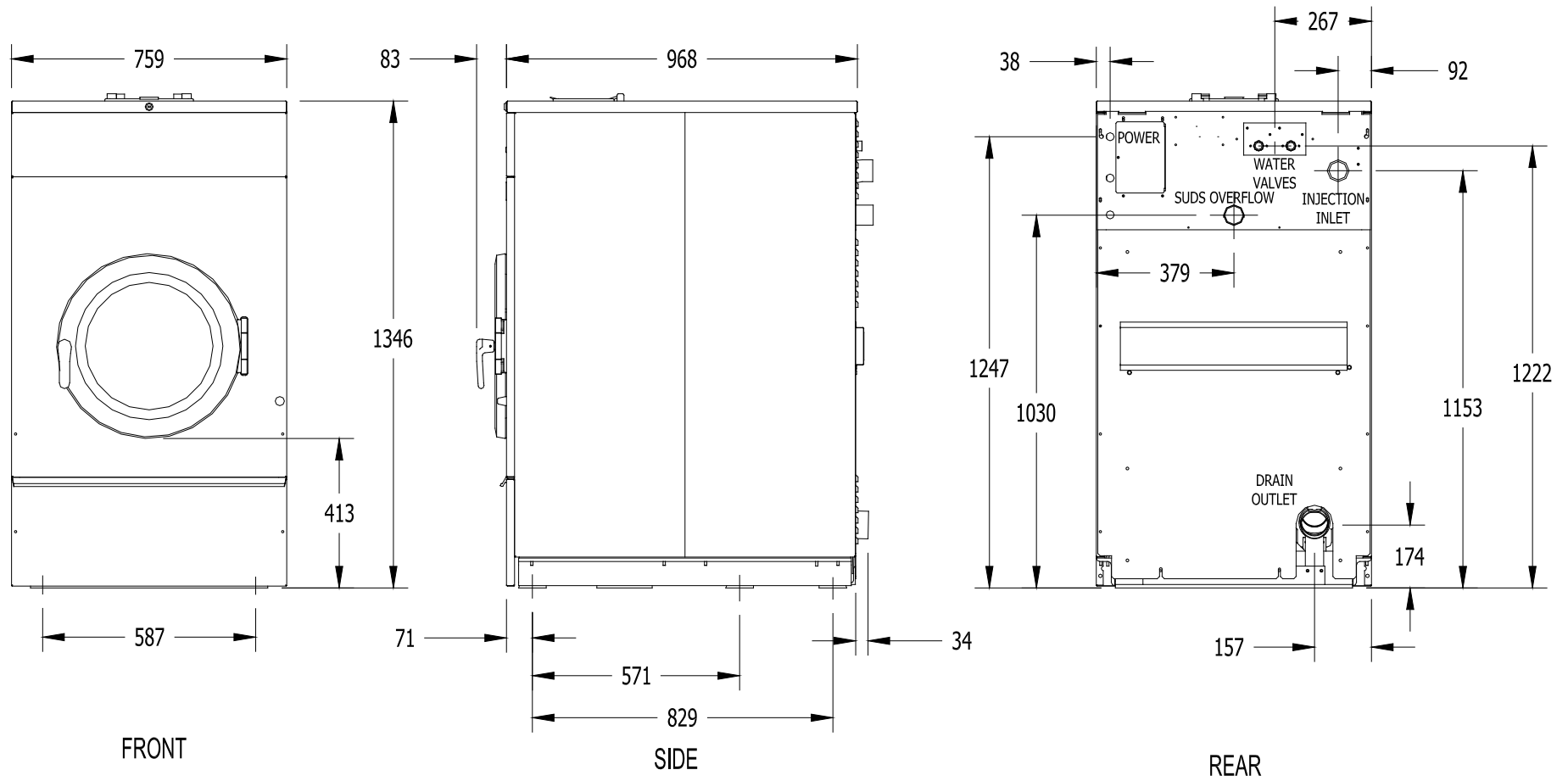

Figure 1-4: T-650 Industrial Washer Mounting Diagram

(Dimensions are in mm)

1.4 PLUMBING

Two 1.22 m (48 inch) water supply hoses are provided with each machine. Use these new hose sets and do not reuse old hose sets. One end of the hoses is ¾-11½ NHT for the water valve connections while the other end of the hoses is ¾-14 BSP for the water supply connections.

Separate hot and cold water lines must be supplied to the machine, maintaining 207 kPa to 827 kPa (30 psi to 120 psi) water flow pressure. A 60°C (140°F) hot water supply is recommended for best washing results. Do not exceed 88°C (190°F) water temperature.

1.5 DRAIN

The drain outlet tube at the rear of the machine is 76mm (3 inches) in diameter. Any drain hose used must be lower than the drain valve to assure proper draining.

1.6 PROTECTIVE FILM

The machine may have protective adhesive film on the front control panel label area and on the front, top, and side stainless steel panels. The film may be peeled off before putting the machine into service.

1.7 ELECTRICAL

The Dexter T-650 single-phase 230VAC 50 Hz and T-650 three-phase 400VAC 50 Hz (with Electric Heater) washing machines are intended to be permanently installed appliances. No power cord is provided. The machine should be connected to an individual branch circuit not shared by lighting or other equipment. A means for disconnection with a contact separation distance of at least 3mm must be provided. The connection should be sheathed in liquid tight flexible conduit, or equivalent, with conductors of the proper size and insulation. The sheath of the supply cord must be at least equivalent to that of a cord complying with IEC 227 or IEC 245. A qualified technician should make such connections in accordance with the wiring diagram with a minimum 3.5 mm² (12 gauge) wire. Models with the electric heat option require a minimum 8.4 mm² (8 gauge) wire. Total power required for heating elements is 15.6 kW (6 elements, 2600 W each).

Individual circuit breakers for each unit are required. Do not use earth-fault circuit breakers or earth-fault circuit interrupter outlets.

WARNING:
SHUT OFF POWER AND WATER BEFORE OPENING ANY SERVICE PANELS.

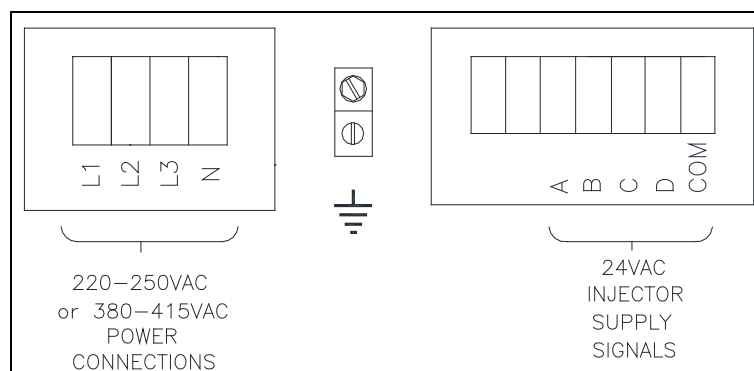

Figure 1-5: Electrical Connections and Chemical Supply Signals

1.7.1 INSTALLING THE ELECTRICAL CONNECTION

- 1.7.1.1 Disconnect all power to the washer.
- 1.7.1.2 Remove the rear panel near the upper left corner of the washer and locate the power terminal block near the back of the control compartment. Connections are as shown in Figure 1-5.
- 1.7.1.3 If power is 380-415-**3PH**-50Hz, connect L1, L2, L3 and Earth. If there is a high leg, it must be connected to L3. However, failure due to a voltage surge on the high leg is not covered by equipment warranty. Contact Dexter Laundry with any questions.
- 1.7.1.4 If power is 220-240-**1PH**-50Hz, connect L1, N, and Earth.

NOTE: It is important that the earthing screw next to the power terminal block TB-1 be connected to a good external earth.

1.7.2 FUSING REQUIREMENTS

Single-phase 230VAC 50 Hz models:

15 AMP TIME-DELAY (DUAL ELEMENT) FUSE (or equivalent circuit breaker)

Three-phase 400VAC 50 Hz models with electric heat source:

30 AMP TIME-DELAY (DUAL ELEMENT) FUSE (or equivalent circuit breaker)

The installation must meet the electrical requirements of the country of installation. The installer must provide a disconnect switch, which will interrupt all lines. It may be a local or national requirement to provide an electrical interruption switch visible and accessible from the room in which the washer is installed.

For destination countries where CE requirements must be met, individual 230V supply disconnecting devices for each dryer are required and must be one of the following types:

- a. switch-disconnector with fuses per IEC 60947-3 utilization category AC-23B;
- b. disconnector with fuses per IEC 60947-3 having an auxiliary contact that in all cases causes switching devices to break the load circuit before the opening of the main contacts of the disconnector;
- c. a circuit-breaker suitable for isolation per IEC 60947-2;
- d. any other switching device in accordance with an IEC product standard for that device and which meets the isolation requirements of IEC 60947-1 as well as a utilization category defined in the product standard as appropriate for on-load switching of motors or other inductive loads;

The supply disconnecting devices must

- a. provide a means allowing the supply disconnecting devices to be locked in the OFF position;
- b. be mounted 0.6 m to 1.9 m above the floor;
- c. be rated for branch circuit operation;
- d. be approved for use in the country where installed;

1.7.3 CONTROLS TRANSFORMER (220-250V models only)

The controls transformer is located inside the control trough and steps a range of 220 to 250 volts down to 24 volts. There are two terminals on the controls transformer for

the primary (incoming) power. Use the terminal marked "220V" for power supplies between 220 and 235 volts. Use the terminal marked "250V" for power supplies between 236 and 250 volts.

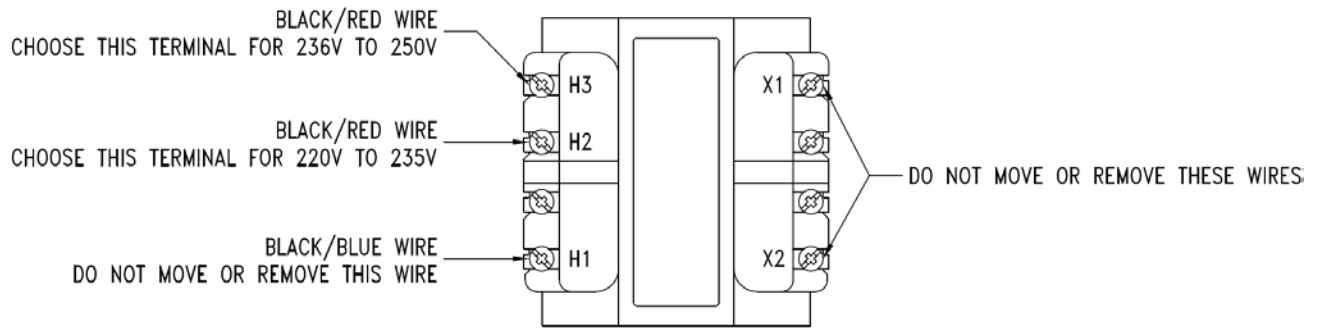

Figure 1-6: Control Transformer Connections

1.7.4 MAXIMUM SPIN SPEED ADJUSTMENT

If desired, the washer can be adjusted to limit the maximum extract spin speed for all wash cycles.

To make this adjustment, a jumper wire must either be installed or removed on the Variable Frequency Drive (VFD), depending on the washer model and desired speed. This Dexter jumper part number 8220-057-036 (qty 1) is factory supplied on terminal points "10V" and "RC". Remove this jumper to make new jumper connections if necessary. Refer to Figure 1-7 for the approximate location of the control terminations on the Variable Frequency Drive (VFD) and Table 2 for appropriate jumper connection points indicated with an "X" for the desired maximum spin speed setting. If no adjustment to default spin speed is desired, do not remove or add any wires on VFD.

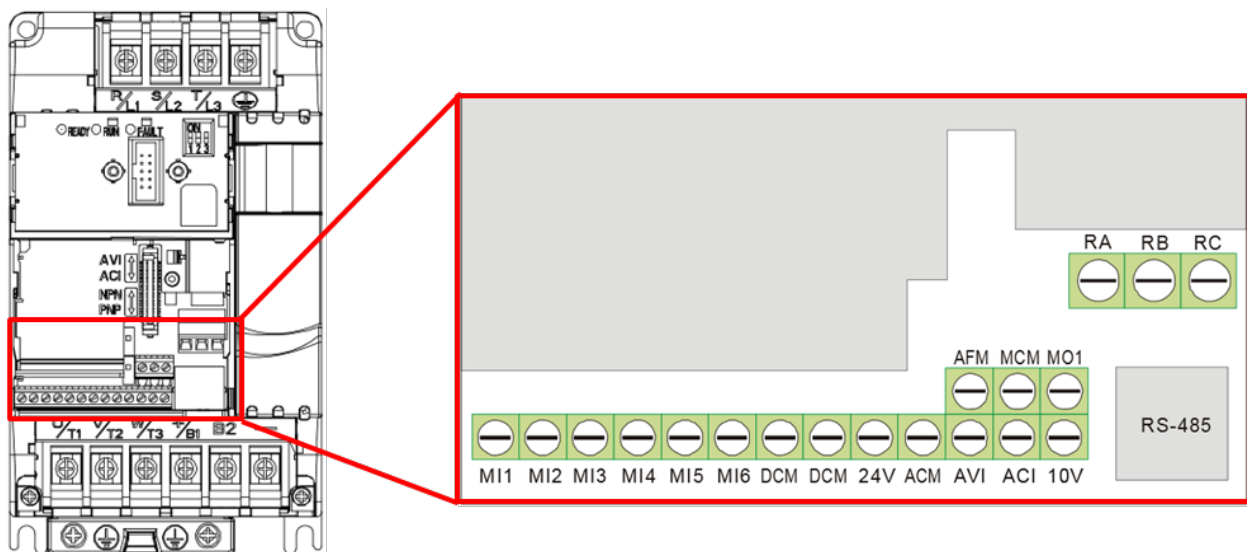

Figure 1-7: Control Terminations on Variable Frequency Drive

N Series Washer Model	Max Spin Speed	Jumper Terminal Locations on Variable Frequency Drive (VFD)													
		MI1	MI2	MI3	MI4	MI5	MI6	DCM (Left)	DCM (Right)	24V	ACM	AVI	ACI	10V	M01
T-600, T-900, T-1200	60 G											X			X
	80 G						X		X						
	100 G	Default Setting (No Jumper Required)													
T-650, T-950, T-1450	100 G											X			X
	140 G	REMOVE Brown Jumper between MI6/M01													
	200 G	Default Setting (With Factory Installed Brown Jumper)													

Table 2: Spin Speed Adjustment Jumper Locations

1.8 INJECTION SOURCE CONNECTIONS

The washer control may be programmed to send six 24V output signals for a chemical injection system of up to four chemical sources. There are convenient electrical connection points for the injection pumps in the rear of the machine, as shown in Figure 1-5. The four independent pumps can be controlled through the signals A, B, C and D. The COM shown in Figure 1-5 is the common or return for these injection signals. For the injection sources, program codes 0 through 6 and their respective terminal block connections and combinations are as shown in Table 3.

Dexter Recommended Connections	Controller Programmed Signals	Injection Terminal Block Circuits
Detergent	1	A
Bleach	2	B
Starch	3	C
Sour/Softener	4	D
	5	A and B
	6	C and D
	0	None

Table 3: Injection Signal and Circuit Identification

Chemical Injection hoses are to be inserted into the injection inlet at the upper right rear of the washer. These hoses should be inserted into the round PVC pipe a minimum of 35.5 cm (14") and a maximum of 45.7 cm (18") to eliminate chemical buildup in the pipe and/or restrict water flow to the tub. Secure the hoses as required.

1.9 OPERATION CHECK

After all mounting, plumbing and electrical work is completed, select any desired wash cycle and run the machine through a complete wash cycle. Check for water leaks and verify proper operation.

During intermediate spin and final spin, the cylinder should turn in a **counterclockwise** direction when viewed from the front of the machine. If spin is clockwise, the T1 and T2 motor wires connecting to terminal T1 and T2 on the variable frequency drive should be swapped. Remove power to the machine before opening service panels and swapping wires.

NOTE: The A-weighted emission sound pressure level does not exceed 70dB(A). The operator does not need hearing protection.

NOTE: The washer does not emit hazardous radiation.



WARNING: To avoid potential risks of spontaneous combustion of a load, remove the load quickly after the completion of the cycle or in case of failure of power supply.



DANGER: Do not wash loads which may create an explosive atmosphere in the washer.

2 OPERATING INSTRUCTIONS

Maximum Load Capacity: 18.2 kg (40 pounds) Dry Weight for the T-650.

2.1 CONTROL BUTTONS

There are four (4) push buttons that control the washer operation. Each button is shown in Figure 2-1, followed by an explanation of each button.

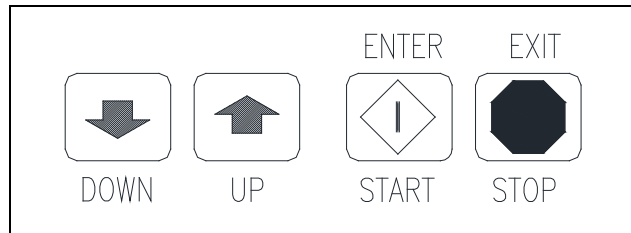

Figure 2-1: Washer Control Keypad Layout

SCROLL DOWN ARROW: Press momentarily / press and hold.

Scroll Down decreases the cycle number displayed by one each time the switch is pressed. When the "DOWN" is held, the display cycle numbers will continue to decrease until cycle #1 is reached at which time the cycle number displayed will rollover to cycle #30 (cycle #31 while in Programming Mode).

SCROLL UP ARROW: Press momentarily / press and hold.

Scroll Up increases the cycle number displayed by one each time the switch is pressed. When the "UP" is held, the display cycle numbers will continue to increase until cycle #30 (cycle #31 while in Programming Mode) is reached at which time the cycle number displayed will rollover to cycle #1.

START/ENTER (green diamond): Press momentarily.

Starts the cycle shown on the display. If a wash cycle is interrupted, pressing the "START" button will resume the cycle from the point at which the cycle was interrupted.

STOP/EXIT (red octagon):

When pressed momentarily, it pauses the washer during the cycle. All washer cycle information is retained, the door remains locked, and the water remains in the tub.

When pressed and held for 3 seconds or longer, it stops the washer, clears the cycle, drains the water, and unlocks the door (up to 3 minutes after the washer is stopped). All washer cycle information is cleared, and it is ready for the next wash cycle.

WARNING:

PRESSING AND HOLDING THE STOP IS AN EMERGENCY STOP BUTTON. HOWEVER, THIS DOES NOT DISCONNECT THE MACHINE FROM THE INPUT POWER.

2.2 STARTING THE WASHER

2.2.1 Turn on power to the washer.

2.2.2 Ensure washer is in "RUN" mode.

Locate the "ADVANCE/RUN/PROGRAM" key switch and key. The current mode is indicated by the alignment of the key slot. If washer is not in "RUN" mode, insert and

turn the key to the "RUN" position.

2.2.3 Load the laundry.

Place laundry loosely into the cylinder and latch the door securely. Be sure laundry does not get caught between the door gasket and tub front when closing the door.

Maximum load is 18.2 kg (40 pounds) clothes, dry weight. Do not load the washer with more than 18.2 kg (40 pounds).

NOTE: To begin closing the door, the handle must be in the horizontal position. After moving the door to the closed position, the handle must be turned down to the vertical position in order to latch the door for machine operation.

2.2.4 Select wash cycle.

Select the appropriate cycle number (1 through 30) for the type of load being washed. See the default cycle descriptions in section 3.3. Use the "UP" and "DOWN" buttons to change the two digit cycle number on the display to the desired cycle.

2.2.5 Add washing chemicals.

If not using a chemical injection system, add low sudsing powdered detergent into the "DETERGENT" compartment of the automatic dispenser on the top of the washer.

If liquid wash products are used in the "DETERGENT" compartment, they must be added at the beginning of the wash cycle.

If desired, add fabric softener to the "FABRIC SOFTENER" compartment. Use the amount of fabric softener as recommended by the manufacturer. This compartment will be flushed during the "FINAL RINSE" segment of the cycle.

If the machine is set for pre-wash, washing products can be added to the round opening of the dispenser or put in with the clothes when loading the washing machine.

If bleach is desired, DO NOT place into dispenser until step 2.2.7.

2.2.6 Press "START".

The door will lock and remain locked until the end of the cycle. The cycle time remaining is displayed throughout the cycle. The cycle number in operation can be displayed by pressing and holding "START", then press "UP". The cycle number will be displayed as long as these two buttons are pressed.

2.2.7 Add bleach if desired.

If you wish to manually add bleach during the cycle, add bleach in the "BLEACH" compartment 3 minutes after the start of the "WASH" cycle.

NOTE: Any additional washing chemicals may be added at the appropriate time by pouring into the round opening on the top of the washer.

2.3 OPTIONAL SOAK

At any time during the cycle, the red "STOP" button can be momentarily pressed to pause the washer. All washer cycle information is retained and the door remains locked. The washer will soak the load for 15 minutes then agitate for 30 seconds. This will repeat until the cycle is started again. This feature allows for an extended soak if required. The washer cycle will continue when the "START" button is pressed.

NOTE: The selected cycle can be cleared at any time by pressing and holding the “STOP” button for a minimum of 3 seconds.

2.4 END OF CYCLE

At the end of the cycle, the machine stops, the “END CYCLE” LED illuminates, the alarm sounds, and the loading door unlocks. The door can now be opened. Immediately remove contents of washer. Leave the door open when the machine is not in use.

2.5 EMERGENCY STOP / SAFETY DOOR LOCK

This machine is equipped with a safety door lock that locks the door when the cycle is started until the cycle is complete. The door lock prevents opening the door for up to 3 minutes if the power is interrupted during the cycle.

Pressing the Emergency Stop button removes power from the controller of the washer. The door can be opened after the Safety Door Lock releases. When the Emergency Stop button is pressed, the washer will begin stopping movement and water flow, and begin draining water from inside the washer. After 6 seconds of power loss to the controller, the motor drive will begin ramping down the motor movement. Though the machine may stop wash movement quickly, it may take up to 3 minutes for the door to unlock. During that time, the door cannot be opened. Twisting clockwise the Emergency Stop button restores power to the controller, which will display a blank screen and sound the alarm. The washer may be reset to the Idle mode by pressing and holding the Stop button until the alarm stops or up to 60 seconds.

2.6 VARIABLE FREQUENCY DRIVE INDICATORS

There are three small red LEDs located on the upper Variable Frequency Drive (VFD) cover. They are labeled as “READY”, “RUN”, and “FAULT” and can be used for troubleshooting. The definitions of the LEDs are listed in Table 4 below.



Washer Condition	“READY” LED Status	“RUN” LED Status	“FAULT” LED Status
Idle Mode (No Cylinder Movement)	ON	OFF	OFF
Tumbling	ON	ON	OFF
Stop from Tumble	ON	FLASHING	OFF
Ramp to Intermediate or Final Extract Spin	ON	ON	OFF
Spinning (Intermediate or Final)	ON	ON	OFF
Stop from Spin (Intermediate or Final)	ON	FLASHING	OFF
Faulted	ON	OFF	ON

Table 4: Variable Frequency Drive Indicators

3 MACHINE PROGRAMMING INSTRUCTIONS

This Dexter T-650 computer control OPL machine has 30 different selectable cycles; 29 of the 30 cycles are preset with the most common industry applications. See section 3.3 for complete cycle information. If these cycle settings do not meet the required application, each cycle is reprogrammable by the user simply and reliably.

Each cycle can have up to 9 baths including Flush, Prewash, Wash, Rinse 1, 2, 3, 4, 5 and Final Rinse/Extract. Each of those baths can be customized with various defined settings including Cycle Time, Water Temperature, Water Level, Spin Time, and Injection Source. Programming can be accomplished manually using the machine controls. Please read below for manual programming instructions.

NOTE: It is recommended when changes are made to one or more of the preset programs that the cycle number and the changes be documented for later reference. Blank cycle tables have been provided at the end of section 3.3.

3.1 EDITING AN EXISTING CYCLE

3.1.1 *Turn on the power to the washer.*

Washer must be in idle mode to program.

3.1.2 *Ensure washer is in "PROGRAM" mode.*

Locate the "ADVANCE/RUN/PROGRAM" key switch and key. The current mode is indicated by the alignment of the key slot. If washer is not in "PROGRAM" mode, insert and turn the key to the "PROGRAM" position.

The display will show a two digit cycle number. The "PROGRAM MODE" LED and "SELECT CYCLE" LED illuminate.

3.1.3 *Select cycle to alter.*

Press the "DOWN" or "UP" buttons on the keypad until the desired cycle number, 1 through 30, is displayed. Do not select cycle 31.

3.1.4 *Press "ENTER" to enter the cycle.*

Once pressed, the first of the nine bath LEDs will illuminate. The "SELECT CYCLE" LED is turned off.

3.1.5 *Select a bath to alter.*

Press the "UP" and "DOWN" buttons to select a bath. The bath indicator lights, shown in Figure 3-1, illuminate to indicate which bath is being selected.

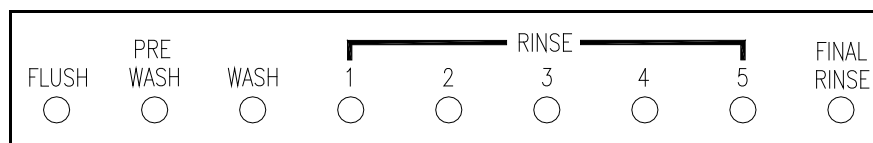

Figure 3-1: Bath Indicator Lights

There are 9 available baths to program: FLUSH, PRE WASH, WASH, RINSE1, RINSE 2, RINSE 3, RINSE 4, RINSE 5 and FINAL RINSE.

3.1.6 *Press "ENTER" to display the settings.*

Available settings to alter in each bath are Cycle Time, Water Temperature, Water Level, Injection Source, and Spin Time.

3.1.7 Input settings.

The first setting to alter is the Cycle Time as indicated by the "CYCLE TIME" LED. Use the "DOWN" and "UP" keys to set the desired time in minutes and press "ENTER" to advance to the next setting. If no change is desired, press "ENTER" to advance to the next setting.

Repeat process for each setting. Each bath setting can be programmed with the options shown in Table 5.

<i>SETTING</i>	<i>OPTIONS</i>
Cycle Time ¹	Two-digit amount of time for bath tumble in minutes. - 00 to 30 minutes for Flush, Prewash, Wash, Rinse 1, 2, 3, 4 and 5. If the time is set to 00, then the bath will be eliminated from the cycle. - 01 to 30 minutes for Final Rinse.
Water Temperature ²	HH for hot water CH for warm water CC for cold water EE for no water ³
Water Level	LO for low level HI for high level
Injection Source ³	Two-digit code indicating injector signal(s), 00 to 06.
Spin Time	Two-digit amount of time for spin in minutes. - 00 to 10 minutes for Flush, Prewash, Wash, Rinse 1, 2, 3, 4, and 5 - 01 to 10 minutes for Final Rinse

Table 5: Bath Program Settings

¹ Cycle times are approximate and do not include fill time from empty to low water level. However, fill time from low to high water level is included as computer operates during this period.

² For models with electric heat, entering a temperature value of 20°-90°C will result in a heated bath if temperature of fill water is less than programmed temperature.

³ Codes for injections sources are defined in Table 3. When "EE" is selected in the Water Temperature setting, the electronic controller prohibits injection signals. The programmed injection source value is ignored.

When the final desired Spin Time setting is selected, press "ENTER". The Spin Time is entered, The "SPIN TIME" LED turns off, and the editing of the selected bath is complete. The next sequential bath light is immediately illuminated.

3.1.8 Program another bath.

If desired, repeat steps 3.1.5 through 3.1.7 to program another bath. Otherwise, continue to the next step.

3.1.9 Program another cycle.

To program a different cycle when any of the nine bath LEDs are illuminated, press the "EXIT" button. The "SELECT CYCLE" LED will immediately illuminate. The programming changes made prior to the program exit are retained and the cycle is updated.

NOTE: When the "FINAL RINSE" bath programming is complete, the cycle

programming is also complete and the "SELECT CYCLE" LED will immediately illuminate. Another cycle can be programmed.

If desired, repeat steps 3.1.3 through 3.1.8 to program another cycle. Otherwise, continue to the next step to end programming.

3.1.10 End programming mode.

When the "SELECT CYCLE" LED is illuminated, turn the key to the "RUN" position. The "PROGRAM MODE" LED will turn off.

NOTE: The Wash Cycle programming mode will automatically exit and return to the Idle mode if no buttons are pressed for one minute.

3.2 PROGRAMMING A NEW CYCLE

The instructions for entering a new cycle are the same as the instructions in section 3.1.

To program a new cycle, an existing cycle number between 1 and 30 must be overridden with a custom program. Cycle 31 cannot be reprogrammed. Only the cycle baths required need to be programmed. Any baths, except FINAL RINSE, can be skipped by entering a "00" time value in the Cycle Time for each unused bath.

3.3 DEFAULT WASHER CYCLE PROGRAMS

The factory default cycles pre-programmed into the washer are listed with each bath and setting option in this section. All wash cycles can be reprogrammed, refer to section 3.1 for instructions.

To reset all customized programs back to original factory default settings, refer to section 3.5 and complete step 14 of the Test Diagnostic Cycle.

Application	Cycle #	Recommendation Description
Shirt/Laundry	1	Shirts – No Starch
	2	Shirts – Starch
Hotel/Motel	3	White Sheets
	4	White Pillowcases
	5	White Towels, Bath Mats, Wash Cloths
	6	Colored Sheets and Towels
	7	Delicate Wash
	8	Housekeeping Rags and Mops
	9	Housekeeping Uniforms
	10	Stain Treatment
	11	Reclaim Part 1
	12	Reclaim Part 2
Health Care	13	Sheets and Pillowcases
	14	Towels
	15	Diapers and Pads
	16	Personals
	17	Delicate
Food & Beverage	18	White (Cotton/Blend) Table Linen
	19	Colored (Cotton/Blend) Table Linen
	20	White 100% Polyester Table Linen
	21	Colored 100% Polyester Table Linen
	22	White Chef Coats
	23	Kitchen and Maintenance Rags
	24	White/Colored (Cotton/Blend) Table Linen
	25	White/Colored 100% Polyester Table Linen
	26	White Chef Coats
	27	Kitchen and Maintenance Rags
Other	28	Oxygen Bleach – Terry
	29	Oxygen Bleach – Terry (No iron)
Test	30	Test Injection Signals and Pressure Switch
	31	<i>Test Diagnostic (not customizable)</i>

Table 6: Default Washer Cycle Programs

Cycle 1 Shirts - No Starch (Shirt/Laundry)

Bath	Bath Cycle Time (min.)	Water Temp.	Water Level	Injection Source	Spin Time (min.)
Flush					
Prewash					
Wash	12	HH	LO	5 (Detergent/Bleach)	
Rinse 1	2	CH	HI		
Rinse 2	2	CH	HI		
Rinse 3	2	CH	HI		
Rinse 4					
Rinse 5					
Final Rinse	4	CH	LO		3

Cycle 2 Shirts - Starch (Shirt/Laundry)

Bath	Bath Cycle Time (min.)	Water Temp.	Water Level	Injection Source	Spin Time (min.)
Flush					
Prewash					
Wash	12	HH	LO	5 (Detergent/Bleach)	
Rinse 1	2	CH	HI		
Rinse 2	2	CH	HI		
Rinse 3	2	CH	HI		
Rinse 4					
Rinse 5					
Final Rinse	7	CH	LO	3 (Starch)	3

Cycle 3 White Sheets (Hotel/Motel)

Bath	Bath Cycle Time (min.)	Water Temp.	Water Level	Injection Source	Spin Time (min.)
Flush					
Prewash	7	HH	LO	1 (Detergent)	
Wash	7	HH	LO	2 (Bleach)	
Rinse 1	2	CH	HI		1
Rinse 2	2	CH	HI		
Rinse 3					
Rinse 4					
Rinse 5					
Final Rinse	4	CH	LO	4 (Sour/Softener)	4

Cycle 4 White Pillowcases (Hotel/Motel)

Bath	Bath Cycle Time (min.)	Water Temp.	Water Level	Injection Source	Spin Time (min.)
Flush	7	HH	LO	1 (Detergent)	
Prewash	1	HH	HI		
Wash	7	HH	LO	2 (Bleach)	
Rinse 1	2	CH	HI		1
Rinse 2	2	CH	HI		
Rinse 3					
Rinse 4					
Rinse 5					
Final Rinse	4	CH	LO	4 (Sour/Softener)	4

Cycle 5 White Towels (Hotel/Motel)

Bath	Bath Cycle Time (min.)	Water Temp.	Water Level	Injection Source	Spin Time (min.)
Flush	7	HH	LO	1 (Detergent)	
Prewash	1	HH	HI		
Wash	7	HH	LO	2 (Bleach)	
Rinse 1	2	CH	HI		1
Rinse 2	2	CH	HI		
Rinse 3					
Rinse 4					
Rinse 5					
Final Rinse	4	CH	LO	4 (Sour/Softener)	5

Cycle 6 Color Sheets (Hotel/Motel)

Bath	Bath Cycle Time (min.)	Water Temp.	Water Level	Injection Source	Spin Time (min.)
Flush					
Prewash					
Wash	7	HH	LO	5 (Detergent/Bleach)	
Rinse 1	2	HH	HI		
Rinse 2	2	CH	HI		1
Rinse 3	2	CH	HI		
Rinse 4					
Rinse 5					
Final Rinse	4	CH	LO	4 (Sour/Softener)	4

Cycle 7 Delicate (Hotel/Motel)

Bath	Bath Cycle Time (min.)	Water Temp.	Water Level	Injection Source	Spin Time (min.)
Flush					
Prewash					
Wash	8	CH	HI	5 (Detergent/Bleach)	
Rinse 1	2	HH	HI		
Rinse 2	2	CH	HI		
Rinse 3	2	CH	HI		
Rinse 4					
Rinse 5					
Final Rinse	4	CH	LO	4 (Sour/Softener)	4

Cycle 8 Rags and Mops (Hotel/Motel)

Bath	Bath Cycle Time (min.)	Water Temp.	Water Level	Injection Source	Spin Time (min.)
Flush	3	CH	HI		
Prewash					
Wash	2	CH	HI		
Rinse 1	2	CH	HI		
Rinse 2	7	HH	LO	1 (Detergent)	
Rinse 3	2	HH	HI		
Rinse 4	7	HH	LO	2 (Bleach)	
Rinse 5	2	CH	HI		1
Final Rinse	2	CH	HI		5

Cycle 9 Uniforms (Hotel/Motel)

Bath	Bath Cycle Time (min.)	Water Temp.	Water Level	Injection Source	Spin Time (min.)
Flush	2	CH	HI		
Prewash					
Wash	7	HH	LO	1 (Detergent)	
Rinse 1	7	HH	LO	2 (Bleach)	
Rinse 2	2	CH	HI		1
Rinse 3	2	CH	HI		
Rinse 4					
Rinse 5					
Final Rinse	4	CH	LO	4 (Sour/Softener)	4

Cycle 10 Stain Treatment – Chlorine Bleach (Hotel/Motel)

Bath	Bath Cycle Time (min.)	Water Temp.	Water Level	Injection Source	Spin Time (min.)
Flush					
Prewash					
Wash	30	HH	LO	5 (Detergent/Bleach)	
Rinse 1	2	HH	HI		
Rinse 2	2	HH	HI		
Rinse 3	2	CH	HI		1
Rinse 4					
Rinse 5					
Final Rinse	2	CH	HI		4

Cycle 11 Reclaim Part 1 (Hotel/Motel)

Bath	Bath Cycle Time (min.)	Water Temp.	Water Level	Injection Source	Spin Time (min.)
Flush					
Prewash					
Wash	20	HH	LO	Manual	
Rinse 1	3	HH	HI		
Rinse 2					
Rinse 3					
Rinse 4					
Rinse 5					
Final Rinse	3	HH	HI		1

Cycle 12 Reclaim Part 2 (Hotel/Motel)

Bath	Bath Cycle Time (min.)	Water Temp.	Water Level	Injection Source	Spin Time (min.)
Flush					
Prewash	3	HH	HI		
Wash	20	HH	LO	Manual	
Rinse 1	3	HH	HI		
Rinse 2	3	HH	HI		
Rinse 3	10	HH	LO	2 (Bleach)	
Rinse 4	3	HH	HI		1
Rinse 5					
Final Rinse	3	CH	HI		4

Cycle 13 Sheets and Pillowcases (Health Care)

Bath	Bath Cycle Time (min.)	Water Temp.	Water Level	Injection Source	Spin Time (min.)
Flush	3	CH	HI		
Prewash	2	CH	HI		
Wash	7	HH	LO	1 (Detergent)	
Rinse 1	7	HH	LO	2 (Bleach)	
Rinse 2	2	CH	HI		1
Rinse 3	2	CH	HI		
Rinse 4					
Rinse 5					
Final Rinse	4	CH	LO	4 (Sour/Softener)	4

Cycle 14 Towels (Health Care)

Bath	Bath Cycle Time (min.)	Water Temp.	Water Level	Injection Source	Spin Time (min.)
Flush	3	CH	HI		
Prewash	2	CH	HI		
Wash	7	HH	LO	1 (Detergent)	
Rinse 1	1	HH	HI		
Rinse 2	7	HH	LO	2 (Bleach)	
Rinse 3	2	CH	HI		1
Rinse 4	2	CH	HI		
Rinse 5					
Final Rinse	4	CH	LO	4 (Sour/Softener)	5

Cycle 15 Diapers (Health Care)

Bath	Bath Cycle Time (min.)	Water Temp.	Water Level	Injection Source	Spin Time (min.)
Flush	3	CH	HI		
Prewash	2	CH	HI		
Wash	2	CH	HI		
Rinse 1	7	HH	LO	1 (Detergent)	
Rinse 2	2	HH	HI		
Rinse 3	7	HH	LO	2 (Bleach)	
Rinse 4	2	CH	HI		1
Rinse 5	2	CH	HI		
Final Rinse	4	CH	LO	4 (Sour/Softener)	4

Cycle 16 Personals (Health Care)

Bath	Bath Cycle Time (min.)	Water Temp.	Water Level	Injection Source	Spin Time (min.)
Flush	3	CH	HI		
Prewash					
Wash	7	HH	LO	5 (Detergent/Bleach)	
Rinse 1	2	HH	HI		
Rinse 2	2	CH	HI		
Rinse 3	2	CH	HI		
Rinse 4					
Rinse 5					
Final Rinse	4	CH	LO	4 (Sour/Softener)	4

Cycle 17 Delicate (Health Care)

Bath	Bath Cycle Time (min.)	Water Temp.	Water Level	Injection Source	Spin Time (min.)
Flush	2	CH	HI		
Prewash					
Wash	7	CH	HI	5 (Detergent/Bleach)	
Rinse 1	2	CH	HI		
Rinse 2	2	CH	HI		
Rinse 3	2	CH	HI		
Rinse 4					
Rinse 5					
Final Rinse	4	CH	HI	4 (Sour/Softener)	3

Cycle 18 White Cotton Table Linen (Food & Beverage)

Bath	Bath Cycle Time (min.)	Water Temp.	Water Level	Injection Source	Spin Time (min.)
Flush	2	CH	HI		
Prewash					
Wash	10	HH	LO	1 (Detergent)	
Rinse 1	2	HH	HI		
Rinse 2	7	HH	LO	2 (Bleach)	
Rinse 3	2	CH	HI		1
Rinse 4	2	CH	HI		
Rinse 5					
Final Rinse	4	CH	LO	6 (Sour/Starch)	4

Cycle 19 Colored Cotton Table Linen (Food & Beverage)

Bath	Bath Cycle Time (min.)	Water Temp.	Water Level	Injection Source	Spin Time (min.)
Flush	2	CH	HI		
Prewash					
Wash	10	HH	LO	1 (Detergent)	
Rinse 1	7	HH	LO	2 (Bleach)	
Rinse 2	2	CH	HI		1
Rinse 3	2	CH	HI		
Rinse 4					
Rinse 5					
Final Rinse	4	CH	LO	6 (Sour/Starch)	4

Cycle 20 White 100% Polyester Table Linen (Food & Beverage)

Bath	Bath Cycle Time (min.)	Water Temp.	Water Level	Injection Source	Spin Time (min.)
Flush	2	CH	HI		
Prewash					
Wash	10	HH	LO	1 (Detergent)	
Rinse 1	2	HH	HI		
Rinse 2	7	HH	LO	2 (Bleach)	
Rinse 3	2	CH	HI		
Rinse 4	2	CH	HI		
Rinse 5					
Final Rinse	4	CH	LO	6 (Sour/Starch)	4

Cycle 21 Colored 100% Polyester Table Linen (Food & Beverage)

Bath	Bath Cycle Time (min.)	Water Temp.	Water Level	Injection Source	Spin Time (min.)
Flush	2	CH	HI		
Prewash					
Wash	10	HH	LO	1 (Detergent)	
Rinse 1	7	HH	LO	2 (Bleach)	
Rinse 2	2	CH	HI		
Rinse 3	2	CH	HI		
Rinse 4					
Rinse 5					
Final Rinse	4	CH	LO	6 (Sour/Starch)	4

Cycle 22 White Chef Coats (Food & Beverage)

Bath	Bath Cycle Time (min.)	Water Temp.	Water Level	Injection Source	Spin Time (min.)
Flush	5	HH	LO	1 (Detergent)	
Prewash	1	HH	HI		
Wash	8	HH	LO	1 (Detergent)	
Rinse 1	2	HH	HI		
Rinse 2	7	HH	LO	2 (Bleach)	
Rinse 3	2	CH	HI		1
Rinse 4	2	CH	HI		
Rinse 5					
Final Rinse	4	CH	LO	4 (Sour)	4

Cycle 23 Kitchen and Maintenance Rags (Food & Beverage)

Bath	Bath Cycle Time (min.)	Water Temp.	Water Level	Injection Source	Spin Time (min.)
Flush	5	HH	LO	1 (Detergent)	
Prewash	2	HH	HI		
Wash	8	HH	LO	1 (Detergent)	
Rinse 1	2	HH	HI		1
Rinse 2	7	HH	LO	2 (Bleach)	
Rinse 3	2	CH	HI		1
Rinse 4					
Rinse 5					
Final Rinse	2	CH	HI		5

Cycle 24 White/Colored (Cotton/Blend) Table Linen (Food & Beverage)

Bath	Bath Cycle Time (min.)	Water Temp.	Water Level	Injection Source	Spin Time (min.)
Flush	2	CH	HI		
Prewash					
Wash	10	HH	LO	5 (Detergent/Bleach)	
Rinse 1	1	HH	HI		
Rinse 2	2	HH	HI		1
Rinse 3	2	CH	HI		
Rinse 4	2	CH	HI		
Rinse 5					
Final Rinse	4	CH	LO	6 (Sour/Starch)	4

Cycle 25 White/Colored 100% Polyester Table Linen (Food & Beverage)

Bath	Bath Cycle Time (min.)	Water Temp.	Water Level	Injection Source	Spin Time (min.)
Flush	2	CH	HI		
Prewash					
Wash	10	HH	LO	5 (Detergent/Bleach)	
Rinse 1	1	HH	HI		
Rinse 2	2	HH	LO		
Rinse 3	2	CH	HI		
Rinse 4	2	CH	HI		
Rinse 5					
Final Rinse	4	CH	LO	6 (Sour/Starch)	4

Cycle 26 White Chef Coats (Food & Beverage)

Bath	Bath Cycle Time (min.)	Water Temp.	Water Level	Injection Source	Spin Time (min.)
Flush	5	HH	LO	1 (Detergent)	
Prewash	1	HH	HI		
Wash	10	HH	LO	5 (Detergent/Bleach)	
Rinse 1	2	HH	HI		
Rinse 2	2	CH	HI		1
Rinse 3	2	CH	HI		
Rinse 4					
Rinse 5					
Final Rinse	4	CH	HI	4 (Sour/Softener)	4

Cycle 27 Kitchen Rags (Food & Beverage)

Bath	Bath Cycle Time (min.)	Water Temp.	Water Level	Injection Source	Spin Time (min.)
Flush	5	HH	LO	1 (Detergent)	
Prewash	2	HH	HI		
Wash	10	HH	LO	5 (Detergent/Bleach)	
Rinse 1	1	HH	HI		
Rinse 2	2	HH	HI		1
Rinse 3	2	CH	HI		
Rinse 4					
Rinse 5					
Final Rinse	2	CH	HI		5

Cycle 28 Oxygen Bleach Terry (Other)

Bath	Bath Cycle Time (min.)	Water Temp.	Water Level	Injection Source	Spin Time (min.)
Flush	3	CH	HI		
Prewash	2	CH	HI		
Wash	10	HH	LO	5 (Detergent/Bleach)	
Rinse 1	2	HH	HI		
Rinse 2	2	CH	HI		1
Rinse 3	2	CH	HI		
Rinse 4					
Rinse 5					
Final Rinse	4	CH	LO	4 (Sour/Softener)	3

Cycle 29 Oxygen Bleach Terry - No Iron (Other)

Bath	Bath Cycle Time (min.)	Water Temp.	Water Level	Injection Source	Spin Time (min.)
Flush	3	CH	HI		
Prewash	2	CH	HI		
Wash	10	HH	LO	5 (Detergent/Bleach)	
Rinse 1	2	HH	HI		
Rinse 2	2	CH	HI		1
Rinse 3	2	CH	HI		
Rinse 4					
Rinse 5					
Final Rinse	4	CH	LO	4 (Sour/Softener)	5

Cycle 30 Pressure Switch and Injection Signals (Test)

Bath	Bath Cycle Time (min.)	Water Temp.	Water Level	Injection Source	Spin Time (min.)
Flush	2	CH	LO	1 (Detergent)	
Prewash					
Wash	7	HH	HI	2 (Bleach)	
Rinse 1	2	CH	HI	3 (Starch)	
Rinse 2	2	CH	HI	4 (Sour/Softener)	
Rinse 3	2	CH	HI		
Rinse 4					
Rinse 5					
Final Rinse	4	CC	HI		3

Cycle _____ Description _____

Bath	Bath Cycle Time (min.)	Water Temp.	Water Level	Injection Source	Spin Time (min.)
Flush					
Prewash					
Wash					
Rinse 1					
Rinse 2					
Rinse 3					
Rinse 4					
Rinse 5					
Final Rinse					

Cycle _____ Description _____

Bath	Bath Cycle Time (min.)	Water Temp.	Water Level	Injection Source	Spin Time (min.)
Flush					
Prewash					
Wash					
Rinse 1					
Rinse 2					
Rinse 3					
Rinse 4					
Rinse 5					
Final Rinse					

Cycle _____ Description _____

Bath	Bath Cycle Time (min.)	Water Temp.	Water Level	Injection Source	Spin Time (min.)
Flush					
Prewash					
Wash					
Rinse 1					
Rinse 2					
Rinse 3					
Rinse 4					
Rinse 5					
Final Rinse					

3.4 RAPID ADVANCE MODE

Rapid Advance mode is a key-controlled override to interrupt the current cycle, drain the water, and advance to the next mode of the wash cycle, including Pre Wash, Wash, Rinse 1, Rinse 2, Rinse 3, Rinse 4, Rinse 5, and Final Rinse. The indicator lights will show to which segment the cycle has been advanced.

To enter the Rapid Advance mode, insert the key into the Rapid Advance/Run/Program lock and turn the key counter-clockwise (CCW). The Rapid Advance mode must be entered during a cycle. If the cycle has not yet started, press the "DOWN" button or the "UP" button to choose a cycle and then the "START" button to begin the cycle.

To advance to the next step in the cycle, press both the "UP" and "START" buttons at the same time. The display will show "Ad" (advance).

If advancing during a bath, all water valves will turn off and the drain will open until the "open drain" step is completed. The cycle will then continue to the next bath or to the spin of the current bath if the programming includes spin time.

If advancing during a chemical injection of a bath or after a chemical injection of the bath but before the low water level is reached, the injector will turn off and the hot and the cold water valves to the tub will turn on until the low water level is reached or for 30 seconds, whichever comes first. Then the drain will open and proceed to the next step after the "open drain" step is completed.

If advancing before a chemical injection of the bath, the drain will open immediately and the cycle will proceed to the next step when the "open drain" step is completed.

If advancing during a spin, the tumbler will begin to decelerate immediately. However, the cycle may proceed to the next bath before the tumbler comes to a complete stop. The cycle cannot be advanced further while the tumbler is decelerating.

If a temperature PCB is installed in the I/O PCB and the temperature programmed from 20°C to 90°C, advancing will turn off the heater relay or steam valve immediately, if either is on, and open the drain after a three second delay. If the display shows a water temperature from 65°C to 90°C (may be displayed by pressing the "DOWN" and "START" buttons together), the drain will close again when the washer indicates empty and the hot and the cold water valves to the tub will turn on until the low water level is reached. The cycle will then continue to the next bath, or if programmed, to the spin of the current bath.

<p>To exit the Rapid Advance mode during the cycle, turn the key to "RUN". The cycle will continue normally.</p>

Notes:

- The cycle cannot be advanced during the "open drain" step of the baths.
- The cycle cannot be advanced when the hot and cold water valves to the tub are on after advancing during or after a chemical injection.
- The cycle cannot be advanced again while the hot and cold water valves to the tub are on after advancing when the water temperature was 65°C to 90°C.
- The Rapid Advance mode may only be entered after a cycle is started.

- The Rapid Advance mode cannot skip the final three tumbles of the cycle. The door lock may remain activated for a couple minutes after the cycle has been completed.
- The chemical injection signals will not turn on if the Rapid Advance mode is entered before the injection.

To end the cycle without waiting for the time to count down, press and hold the "STOP" button for 5 seconds or more. The display will then show the cycle number and be ready to start the cycle.

3.5 DIAGNOSTIC TEST CYCLE

There is a diagnostic test cycle to assist in both verifying correct operation of the washer and identifying functional problems with the machine.

The diagnostic program, cycle #31, is an individual function test. This program tests most of the functions of the machine including water valves, drive system, door lock, etc.

Two important notes about the diagnostic cycle:

- Cycle Terminate: At any time during the diagnostic cycle, pressing and holding the stop button for a minimum of 3 seconds terminates washer activities and clears the cycle.
- Injection Signals: The injection signals are not tested during the diagnostic cycle.

Cycle 31 Sequence - Short individual function test

3.5.1 Close the washer door.

3.5.2 Turn the control key to the "PROGRAM" mode.

The "PROGRAM MODE" LED will illuminate.

3.5.3 Select Test Cycle 31.

Pressing the "UP" and "DOWN" buttons, scroll through the cycles until the display reads "31".

3.5.4 Press "START".

All lights will be on and "00" will be in the display.

From this point, the operator must observe the functions of the washer with the washer top panel removed to ensure correct operation. Each step in this test will turn on an output on the I/O interface assembly, and the corresponding red LED on the I/O interface assembly will light. The outputs are clearly marked.

3.5.5 Press the "UP" button.

The display will show "01".

For each number in the test, the function will be active when the "START" button is pressed and will be inactive when the "START" button is released. Press the "UP" button to move from one function to the next.

The sequence of operation for the diagnostic cycle is explained below:

Step 01: Door Lock Mechanism (Door Sol. #3 red LED and Green input LEDs #4 and #5 will be lit.)

Step 02: Door Locking Thermoactuator (Lock Thermo #2 red LED will be lit.)

Step 03: Door Unlocking Thermoactuator (Unlock Thermo #1 red LED will be lit.)

Step 04: Close Drain Valve (Drain Valve #4 red LED will be lit.)

Step 05: Cold Water Valve for the tub (Cold Tub #7 red LED will be lit.) The pressure switch low level setting can be tested at this point. The drain valve is closed and cold water is on for as long as the "START" button is pressed. When the water level reaches a low level, the water valve will turn off and no additional cold water can be added. Green input LED #13 should now be lit.

Step 06: Cold Water Valve for the dispenser (Cold Dispenser #6 red LED will be lit.) For models with electric heat only, this provides power to the heat relay, however the heat relay will not energize due to low level safety relay. The pressure switch low level setting can also be tested with this step. See Step 05 for additional details.

Step 07: Hot Water Valve for the tub (Hot Tub #5 red LED will be lit.) The pressure switch high level setting can be tested at this point. The drain valve is closed and hot water on for as long as the "START" button is pressed. When the water level reaches a high level, the water valve will turn off and no additional hot water can be added. Green input LED #15 should now be lit.

Step 08: Hot Water Valve for the dispenser (Hot Dispenser #8 red LED will be lit.) The pressure switch high level setting can also be tested with this step. See Step 07 for additional details.

Step 09: Tumble clockwise (FWD. #13 red LED will be lit)

Step 10: Tumble counter clockwise (REV. #14 LED will be lit)

Step 11: Open Drain Valve (ensures that drain valve is open before spin)

Step 12: Intermediate Extract (Rev. #13 and Speed 1 #15 red LEDs will be lit.)

Step 13: High Speed Extract (Rev. #13, Speed 1 #15, and Speed 2 #16 red LEDs will be lit.)

IMPORTANT:

Do not use step 14 if you have customized any wash cycles as this will reset the cycles back to the factory default settings. Step 14 will delete any changes made to all 30 cycles.

Step 14: Reset all 30 cycles to Factory Settings. Press and hold "START" and press "UP". This will reset the 30 preset cycles back to the factory settings.

Step 15: Calibrate temperature control board (MODELS WITH ELECTRIC HEAT ONLY). Move cal/run switch on temperature control board to the calibrate position. Adjust calibration screw so display shows 98.

To end the Test at any time, press "STOP" and the machine will return to the programming mode with cycle 31 displayed.

To exit the Test mode, turn the "Advance/Run/Program" Key back to the "RUN" position.

3.6 WATER LEVEL ADJUSTMENT

The water level of all baths can be adjusted by changing the switch settings on the electronic pressure sensor. On-premise washers are shipped with the pressure sensor harness connected to Switch #1 for "LO" level and Switch #2 for "HI" level.

Water level adjustments can also be made in 6mm (1/4") increments by adjusting the switch positions for the desired level. It is not recommended for the water level to be set above the factory Switch #2 settings. Refer to the following chart for the switch settings and the factory default settings:

Water Level Chart									
Switch Positions:							Factory Settings:		
Depth (mm):	Pos 1	Pos 2	Pos 3	Pos 4	Pos 5	Pos 6	Model	OPL	
								Switch #1 Depth (mm):	Switch #2 Depth (mm):
127	off	off	off	off	off	off			
133	on	off	off	off	off	off			
140	off	on	off	off	off	off			
146	on	on	off	off	off	off			
152	off	off	on	off	off	off	T-300	152	171
159	on	off	on	off	off	off	T-350	152	171
165	off	on	on	off	off	off	T-400	203	279
171	on	on	on	off	off	off	T-450	152	216
178	off	off	off	on	off	off	T-450 SWD	152	216
184	on	off	off	on	off	off	T-600	203	279
191	off	on	off	on	off	off	T-650	203	279
197	on	on	off	on	off	off	T-750	152	222
203	off	off	on	on	off	off	T-750 SWD	235	298
210	on	off	on	on	off	off	T-900	152	222
216	off	on	on	on	off	off	T-950	152	222
222	on	on	on	on	off	off	T-1200	152	222
229	off	off	off	off	on	off	T-1450	171	241
235	on	off	off	off	on	off			
241	off	on	off	off	on	off			
248	on	on	off	off	on	off			
254	off	off	on	off	on	off			
260	on	off	on	off	on	off			
267	off	on	on	off	on	off			
273	on	on	on	off	on	off			
279	off	off	off	on	on	off			
286	on	off	off	on	on	off			
292	off	on	off	on	on	off			
298	on	on	off	on	on	off			
305	off	off	on	on	on	off			
311	on	off	on	on	on	off			
318	off	on	on	on	on	off			
324	on	on	on	on	on	off			
330	off	off	off	off	off	on			
337	on	off	off	off	off	on			
343	off	on	off	off	off	on			
349	on	on	off	off	off	on			
356	off	off	on	off	off	on			
362	on	off	on	off	off	on			
368	off	on	on	off	off	on			
375	on	on	on	off	off	on			
381	off	off	off	on	off	on			

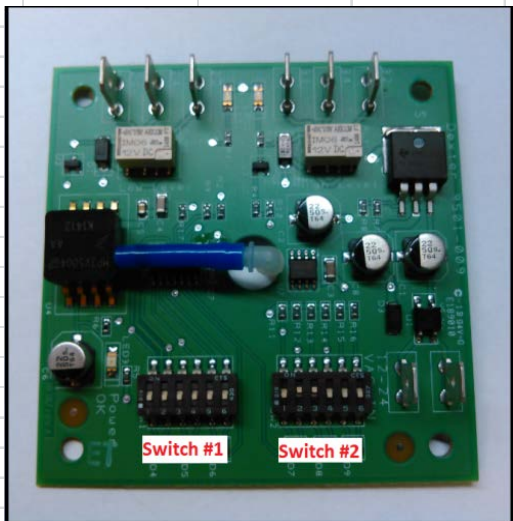

4 TROUBLESHOOTING

CAUTION: Label all wires prior to disconnection when servicing controls. Wiring errors can cause improper and dangerous operation. Verify proper operation after servicing.

If any of the following symptoms occur on this washer, check the suggested remedies listed below. If all probable causes have been eliminated and the symptom still exists, contact your local Dexter agent for further troubleshooting assistance. See contact information at the end of this manual. Parts & Service Manuals from Dexter are also available for further troubleshooting assistance.

Symptom	Probable Cause	Suggested Remedy
Machine does not start	Power Supply	Check these areas: Circuit breakers, Voltage, Power leads, Power connections. Is front display LED lit?
	"START" button	Check for green start button light on Input/Output PCB #6 when button is pressed. If no light, check membrane switch assembly and ribbon cable.
	Door Switch	Check for continuity through door switches when door is closed and locked. Check Input/Output PCB for green door closed light #4 and green door locked light #3 showing that door switches are functioning correctly. If no continuity or green light on when door closed and start button pressed, check door switch and wiring assembly.
	Control Circuit Breaker	Check circuit breaker for continuity. If no continuity, replace breaker.
	Control Transformer	Check voltage output from control transformer for 24VAC. If voltage is incorrect, replace transformer.
	Check PCB board	Check all wire connections for sure contacts.
	CPU board	Single red light should be illuminated. If light is flashing or not on, remove power from washer for 2 minutes to reset board. Reapply power to washer and check red light. If on solid, all okay. If still flashing or not on, replace CPU board.
	Check Relay PCB	Check all wire connections for sure contact.
	Check Door Lock Mechanism	Check that 24VAC power is at mechanism after start button is pressed.
Machine starts then stops	Door switch assembly	I/O PCB must have green input lights: DOOR LOCK #3, DOOR CLOSED #4, TUB EMPTY #14, RUN KEY #1. START #1 will be on when pressed. If these are not on, check door switches and wiring to/from control panel.
	Door locking mechanism	Check if I/O PCB red output light DOOR SOL. #3 is on. Check that 24VAC power is at mechanism. Is the linkage rod adjusted properly?
Door does not lock	CPU Board, Ribbon Cable or Input/Output Board	Check Input/Output PCB for green input door closed light #4 and green input door locked light. DOOR SOL. #3 light should be illuminated. If light is flashing or not on, remove power from washer for 2 minutes to reset CPU. Reapply power to washer and check red CPU light. If on solid, CPU is okay. If still flashing or not on, replace CPU board. If CPU tests okay, change Ribbon Cables between CPU and Input/Output PCB. (Check with Dexter Support for latest testing procedures for I/O PCB.) If no voltage, replace I/O PCB.
	Door lock motor	Check to ensure that door lock motor is receiving 24VAC from Input/Output PCB. Is I/O PCB red output light #3 on? If 120VAC and output light is lit, replace door lock motor.
	Door Switch	Check for continuity through door latch switch when door closed. If no continuity, adjust or replace door switch.

Door will not open	Thermoactuator	Check to see if thermoactuator(s) and/or its mechanism are stuck or binding and not allowing the door lock motor to open. Check to be sure that red light on Input/Output PCB for locking thermoactuator is not illuminated and that Input/Output PCB is not sending 24VAC power to the locking thermoactuator during the last 70 seconds of the cycle. Check to be sure that red light on Input/Output PCB for unlocking thermoactuator #1 is illuminated and that Input/Output PCB is sending 24VAC to the unlocking thermoactuator during the last 30 seconds of the cycle.
	Door Rod	Check to see that door rod from mechanism to lock assembly is long enough to allow lock assembly to disengage. If not, adjust rod.
	Door locking mechanism	Check that door lock mechanism is not stuck closed. Check to be sure that Input/Output PCB is not sending 24VAC power to door locking motor. Be sure that red light on Input/Output PCB for DOOR SOL #3 is not illuminated. If door lock motor is receiving 24VAC, check CPU, Ribbon Cable and Input/Output PCB above.
	CPU Board, Ribbon Cable or Input/Output Board	Check red DOOR SOL #3 light on input/output board. If illuminated, remove power to washer for 2 minutes to reset CPU board. Reapply power to washer and check red DOOR SOL #3 light. If no light, okay. If red light is still on, check the CPU board as described above under "Door does not lock". If CPU tests okay, change Ribbon Cables between CPU and input/output board. If red door DOOR SOL #3 light on input/output board is illuminated, check that 120VAC is going from the input/output board to the door locking solenoid. If no voltage, replace I/O PCB.
Machine starts but will not advance in the cycle	Water valves	Check to ensure that water valves are operating. If not, check to be sure that red light on Input/Output PCB for water valves is illuminated (#5, #6, #7, #8) and that input/output board is sending 24VAC to the water valve. If 24VAC, change water valve. If no voltage, check Input/Output PCB.
	Drain valve	Check to ensure that drain valve is closing. If not, check for 24VAC to drain valve from Input/Output PCB red light #4. If 24VAC, change or clean drain valve. If no voltage, check CPU board, ribbon cable and I/O PCB.
	Fill hose or Water valve screens	Check all screens for obstructions and clean.
	Water	Check to ensure that water is turned on and operating.
	Pressure Switch Hose	Check hose for holes. Be sure the inlet end of the large part of the hose is lower than the rest of the hose and is free of debris.
	Pressure switch	Pressure switch must be in the low or high position to close the circuit to the input/output board. Either the green low level or high level light on the input/output board must be lighted. Check pressure switch continuity between terminals #31 & #22 for low level and #31 and #32 for high level.
	CPU Board, Ribbon Cable, or input/output board	Check if Input/Output PCB for red output LEDs will not light for water valve and drain valve (#4,5,6,7,8). If no output lights illuminated, check single red light on CPU board. Single red light should be illuminated. If light is flashing or not on, remove power from washer for 2 minutes to reset board. Reapply power to washer and check red CPU light. If on solid, CPU okay. If still flashing or not on, replace CPU board. If CPU tests okay, change Ribbon Cables between CPU and input/output board. Check GREEN input LED #14 tub empty has lit in a drain mode of formula. Make sure Green input LEDs #13 or #14 are lit if Fill portion of formula is being called for. If red drain valve or water valve output light on Input/Output PCB is lit, check to ensure that 24VAC is going from the Input/Output PCB to the drain valve or water valve. If no voltage, replace I/O PCB.

Machine starts and advances through cycle, but motor does not operate	Variable Frequency Drive and Motor	<p>Check small green, blue, orange, black, white, red wires (shielded cable) from the VFD to ensure a good connection at each termination point at drive or at relays and including all molex connectors.</p> <ol style="list-style-type: none"> 1. Disconnect power to washer for 2 minutes to reset motor drive. 2. Check incoming power to washer for correct voltage. Line voltage out of the specified operating range will cause the drive to fault, lighting the red light. 3. Check motor. Disconnect from power. Disconnect the three wires that operate the motor from terminals T-1, T-2, T-3 in the drive. Reconnect power to the washer.
	CPU board, Ribbon Cable Input/Output PCB	<p>Check Input/Output PCB for illuminated red motor output lights. If no red output lights illuminated, check single red light on CPU board. Single red light should be illuminated. If light is flashing or not on, remove power from washer for 2 minutes to reset board.</p> <p>Reapply power to washer and check red CPU light. If on solid, CPU okay. If still flashing or not on, replace CPU board. If CPU tests okay, change Ribbon Cables between CPU and Input/Output PCB. (Check with factory for latest testing procedures for I/O PCB.) If red motor output lights on Input/Output PCB are illuminated, check to ensure that 0VDC is going from the input/output board to the variable frequency drive. If no voltage, replace I/O PCB.</p>
	Run Relay	<p>Check to see if there is 12VDC to relay coil. If not, check I/O PCB for 12VDC output. Check if 0VDC through contacts (white wire) to I/O PCB.</p>
Machine washes but does not give intermediate spin	Pressure Switch	<p>Pressure switch must be in the empty position to does not give close the circuit to the Input/Output PCB. The intermediate spin green input tub empty light #14 on the Input/Output PCB must be lighted. Check pressure switch for continuity across terminals indicating pressure switch has reset to empty.</p>
	Variable Frequency Drive	<p>Check Variable Frequency Drive. Check all wires on drive to ensure a good connection. Check LED display at VFD before powering down</p> <ol style="list-style-type: none"> 1) Disconnect power to washer for 2 minutes to reset motor drive. Reconnect to power and check for LED display on VFD. 2) Check incoming power to washer for correct voltage. Line voltage out of the specified operating range will cause the drive to fault.
	CPU board, Ribbon Cable Input/Output PCB	<p>Check Input/Output PCB for illuminated red output light for intermediate spin #15 and #14 for reverse. If no red output light illuminated, check single red light on CPU board. Single red light should be illuminated. If light is flashing or not on, remove power from washer for 2 minutes to reset board. Reapply power to washer and check red CPU light. If on solid, CPU okay. If still flashing or not on, replace CPU board. If CPU tests okay, change Ribbon Cables between CPU and Input/Output PCB. (Check with factory for latest testing procedures for I/O PCB) If red intermediate spin output light # 15 on the Input/Output PCB is illuminated, check to ensure that 0VDC is going from the Input/Output PCB to the variable frequency drive. If no voltage, replace I/O PCB.</p>
Intermediate speed #1 works, but no high speed #2	Variable Frequency Drive and Motor	<p>Check small green, black, white wires (shielded cable) from the VFD to ensure a good connection at each termination point at drive or at relays and including all molex connectors. Check that green hi speed wire at drive terminal is giving a 0VDC reading between white and green and assure that signal is getting to drive.</p> <ol style="list-style-type: none"> 1. Disconnect power to washer for 2 minutes to reset motor drive. 2. Reconnect to power and check for run light. Run--okay. 3. Check incoming power to washer for correct voltage. Line voltage out of the specified operating range will cause the drive to fault. 4. Check motor. Disconnect from power. Disconnect the three gray wires that operate the motor from terminals T-1, T-2, and T-3 in the drive. 5. Reconnect power to the washer.

Intermediate speed #1 works, but no high speed #2 (continued)	CPU board, Ribbon Cable Input/Output PCB	Check input/output PCB for illuminated red speed 1 #15 and high speed 2 #16 output lights. If no red output lights illuminated, check single red light on CPU. Single red light should be illuminated. If light is flashing or not on, remove power from washer for 2 minutes to reset board. Reapply power to washer and check red CPU light. If on solid, CPU okay. If still flashing or not on, replace CPU. If CPU tests okay, change Ribbon Cables between CPU and input/output PCB. (Check with factory for latest testing procedures for I/O PCB.) If red intermediate and high extract output lights on input/output board are illuminated, check to ensure that 0VDC is going from the Input/Output PCB to the variable frequency drive. If no voltage, replace I/O PCB.
Machine tumbles in only one direction	Variable Frequency Drive	Check blue and orange wires on variable frequency drive for alternating 0V to 24 VDC for forward and reverse direction from the Input/Output PCB. If no voltage, see CPU board, Ribbon Cable or Input/Output PCB below. Be sure to check wire connections at drive.
	CPU Board, Ribbon Cable, or input/output board	Check Input/Output PCB for alternating or Input/Output PCB red output lights for forward #13 and reverse #14. If no red output lights illuminated, check single red light on CPU board. Single red light should be illuminated. If light is flashing or not on, remove power from washer for 2 minutes to reset board. Reapply power to washer and check red CPU light. If on solid, CPU okay. If still flashing or not on, replace CPU board. If CPU tests okay, change Ribbon Cables between CPU and Input/Output PCB. If red forward #13 and reverse #14 output lights on the Input/Output PCB are illuminated, check to ensure that 0VDC is going from the Input/Output PCB to the variable frequency drive (only when the lights are on). When lights are off, check to ensure that 24VDC is going from the Input/Output PCB to the variable frequency drive. If neither voltage is correct, replace I/O PCB.
Excessive vibration	Mounting System	Check these areas: <ul style="list-style-type: none"> • Strength of mounting structure, concrete or base. • Mounting bolts may be loose and need tightening.
	Drive Belt	Worn drive belt can cause vibration and noise.
	Pulleys	Check for damaged pulleys.
	Under loading	Wash recommended load size as specified for washer model (in lb/kg). Small loads contribute to out of balance loading and increase vibration.
Hot or Cold water does not enter the tub	Water Valves	Check to ensure that water valve is operating. If not, check for 24VAC to water valve from Input/Output PCB. If 24VAC, change water valve. If no voltage, check Input/Output PCB as described below.
	Fill Hose or Water Valve screens	Check water inlet screens for blockage and clean if necessary.
	Water	Check to ensure that water is turned on and operating.
	Pressure Switch Hose	Check hose for holes. Be sure the inlet end of the large part of the hose is lower than the rest of the hose and is free of debris.
	Pressure Switch	Pressure switch must be in the empty position to close the circuit to the Input/Output PCB. The green Empty light #14 on the Input/Output PCB must be lighted. Check pressure switch for continuity across terminals #31 & #22 indicating pressure switch has reset to empty.
	CPU board, Ribbon Cable Input/Output PCB	Check Input/Output PCB for illuminated red water or Input/Output PCB valve output light. If no red output light #5 (for Hot) or #7 (for Cold) illuminated, check single red light on CPU board. Single red light should be illuminated. If light is flashing or not on, remove power from washer for 2 minutes to reset board. Reapply power to washer and check red CPU light. If on solid, CPU okay. If still flashing or not on, replace CPU board. If CPU tests okay, change Ribbon Cables between CPU and Input/Output PCB. If red water valve output light #5 (for Hot) or #7 (for Cold) on input/output PCB is illuminated, check to ensure that 24VAC is going from the Input/Output PCB to the water valve. If no voltage, replace I/O PCB.

No hot water in detergent dispenser	Water valves	Check to ensure that water valve is operating. If not, check for 24VAC to water valve from Input/Output PCB. If 24VAC, change water valve. If no voltage check Input/Output PCB.
	Fill hose or Water valve screens	Check water inlet screens for blockage and clean screens if necessary.
	Water	Check to ensure that water is turned on and operating.
	CPU board, Ribbon Cable Input/Output PCB	Check Input/Output PCB for illuminated red or Input/Output PCB water valve output light. If red output light #8 is not illuminated, check single red light on CPU board. Single red light should be illuminated. If light is flashing or not on, remove power from washer for 2 minutes to reset board. Reapply power to washer and check red CPU light. If on solid, CPU okay. If still flashing or not on, replace CPU board. If CPU tests okay, change Ribbon Cables between CPU and Input/Output PCB. If red water valve output light #8 on input/output PCB is illuminated, check to ensure that 24VAC is going from the Input/Output PCB to the water valve. If no voltage, replace I/O PCB.
Water does not flush softener compartment	Water Valves	Check to ensure that water valve is operating. If not, check for 24VAC to water valve from Input/Output PCB. If 24VAC, change water valve. If no voltage check Input/Output PCB.
	Fill hose or Water valve screens	Check all screens for obstructions and clean.
	Water	Check to ensure that water is turned on and operating.
Water comes in but level does not rise	Drain Valve	Check these areas: <ul style="list-style-type: none"> • Drain valve blockage • Drain valve motor and gear train. If power but drain valve does not close, replace valve. • Power to the drain valve. If no power to drain valve, check (brown/yellow) circuit for power.
	Water Valves	Check or replace water valve diaphragms.
Water level too high	Pressure Switch	Pressure switch must be in the low or high position to close the circuit to the Input/Output PCB. Either the green low level #13 or high level light #15 on the Input/Output PCB must be lighted. Check pressure switch continuity between terminals #31 & #22 for low level and #31 and #32 for high level.
	Pressure Switch Hose	Check hose for holes. Be sure the inlet end of the large part of the hose is lower than the rest of the hose and is free of debris.
	CPU board, Ribbon Cable Input/Output PCB	Check Input/Output PCB for illuminated green low #13 or high level input light #15. If green input light is illuminated, check single red light on CPU board. Single red light should be illuminated. If light is flashing or not on, remove power from washer for 2 minutes to reset board. Reapply power to washer and check red CPU light. If on solid, CPU okay. If still flashing or not on, replace CPU board. If CPU tests okay, change Ribbon Cables between CPU and Input/Output PCB. (Check with factory for latest testing procedures for I/O PCB.) If still not corrected, change Input/Output PCB.
Water drains slowly	Drain System	Check hoses and drain valve for blockage. Clean if necessary. Check building drains for blockage or inadequate size.
Water leakage around loading door	Door Adjustment	Door may need adjustment due to abuse or wear. Check tightness around perimeter using a dollar bill. Adjust left to right tightness by shims at door lock or hinge side. It is important to center gasket to tub opening before tightening door to hinge bolts. Chalk may be used on tub front to show point of contact with tub. If gasket is deformed, worn, or damaged, replace.

IMPORTANT

TRANSIENT VOLTAGE SURGE SUPPRESSORS

Like most electrical equipment your new machine can be damaged or have its life shortened by voltage surges due to lightning strikes which are not covered by factory warranty. Local power distribution problems also can be detrimental to the life of electrical components. We recommend the installation of transient voltage surge suppressors for your new equipment. These devices may be placed at the power supply panel for the complete installation and don't require an individual device for each machine.

These surge protectors help to protect equipment from large spikes and also from small ongoing spikes in the power that occur on a day to day basis. These smaller surges can shorten overall life of electrical components of all types and cause their failure at a later date. Although they can't protect against all events, these protective devices have a good reputation for significantly lengthening the useful life of electronic components. Electronic components are helped to have a longer useful life when they are supplied with the clean stable electrical power they like.

We are including the following names and phone numbers of a few suppliers of these devices for those who don't currently have a source.

<u>MANUFACTURER</u>	<u>CONTACT</u>	<u>PHONE</u>
Innovative Technology, Inc (Part of Eaton Corporation)	Distributor	1-800-809-2772 or www.itvss.com
EFI Electronics Corporation (Part of Schneider Electric)	Factory	1-800-877-1174
MCG Surge Protection	Factory	1-800-851-1508 or www.mcgsurge.com
Advanced Protection Technologies Inc.	Factory	1-800-237-4567 or www.aptsurge.com

5 SERVICE AND PARTS

The following parts are provided with each machine for use in installation.

<u>Dexter Part Number</u>	<u>Description</u>	<u>Quantity</u>
9990-027-017	Hose, Water Supply, Red	1
9990-027-018	Hose, Water Supply, Blue	1
8641-242-000	Washer, Inlet Hose	2
9565-003-001	Strainer, Inlet Hose	4

Contact distributor or Dexter Laundry, Inc. if a steel-mounting base is required.

COMMON SERVICE PARTS

Part Description	Dexter Part Number
Circuit Breaker – 7A.	5198-211-002
Motor – 2hp	9376-319-001
Drive – Variable Frequency, 2hp	9375-030-015
Belts - Drive	9040-076-005
PCB Assembly – Display	9799-001-001
PCB Assembly - CPU	9799-002-003
PCB Assembly - I/O Interface	9799-003-003
Valve – Water	9379-183-011
Valve – Drain, 2" Ball	9379-200-002
Switch – Door Closure	9539-492-001

For service and parts information, contact your local Dexter agent. To find your local Dexter agent, use the Distributor Locator at the website shown below. If a Dexter agent is not available, contact **Dexter Laundry, Inc.** directly as listed below:

Mailing Address: 2211 West Grimes Avenue Phone: 1-800-524-2954
Fairfield, IA 52556
USA

Website: www.dexter.com



EC DECLARATION OF CONFORMITY WITH COUNCIL DIRECTIVE 2006/42/EC		CE
Directive:	Machinery Directive on machinery safety, 2006/42/EC	
Conforming Machinery:	Commercial Washing System Model Numbers: WN0300, WN0350, WN0400, WN0450, WNS450, WN0600, WN0650, WN0750, WNS750, WN0900, WN0950, WN1200, WN1450 Serial Numbers:	
Manufacturer:	Dexter Laundry, Inc. 2211 West Grimes Avenue Fairfield, IA 52556 USA	
Harmonised Standards Referenced or Applied:	EN ISO 12100:2010	Safety of machinery. General principles for design. Risk assessment and risk reduction.
	EN 349:1993+ A1:2008	Safety of machinery. Minimum gaps to avoid crushing of parts of the human body.
	EN 614-1:2006+ A1:2009	Safety of machinery. Ergonomic design principles. Terminology and general principles.
	EN 953:1997+ A1:2009	Safety of machinery. Guards. General requirements for the design and construction of fixed and movable guards.
	EN 1037:1995+ A1:2008	Safety of machinery. Prevention of unexpected start-up.
	EN ISO 13857:2008	Safety of machinery. Safety distances to prevent hazard zones being reached by upper and lower limbs.
	EN ISO 14119:2013	Safety of Machinery. Interlocking devices associated with guards. Principles for design and selection.
	EN ISO 10472-1:2008	Safety requirements for industrial laundry machinery. Common requirements.
	EN ISO 10472-2:2008	Safety requirements for industrial laundry machinery. Washing machines and washer- extractors.
	EN 60335-1:2012/ AC:2014	Safety of machinery. Electrical equipment of machines. General requirements.
Specifications with which Conformity is Declared:	Essential Health and Safety Requirements of Annex1 of the Machinery Directive	
We hereby certify that the machinery described above conforms with the essential health and safety requirements of Council Directive 2006/42/EC on the approximation of the laws of the Member States relating to the safety of machinery.		
Date:		
Signed:		
Signatory:	Mark Cox Director of Engineering	



EC DECLARATION OF CONFORMITY WITH COUNCIL DIRECTIVE 2004/108/EC		CE
Directive:	Electromagnetic Compatibility Directive 2004/108/EC	
Conforming Machinery:	Commercial Washing System Model Numbers: WN0300, WN0350, WN0400, WN0450, WNS450, WN0600, WN0650, WN0750, WNS750, WN0900, WN0950, WN1200, WN1450	
Manufacturer:	Dexter Laundry, Inc. 2211 West Grimes Avenue Fairfield, IA 52556 USA	
Harmonised Standards Referenced or Applied:	EN 55014-1:2006/A2:2011 CISPR 14-1:2005/A2:2011	Electromagnetic compatibility. Requirements for household appliances, electric tools and similar apparatus. Emission.
	EN 55014-2:1997/A2:2008 CISPR 14-2:1997/A2:2008	Electromagnetic compatibility. Requirements for household appliances, electric tools and similar apparatus. Immunity. Product family standard.
	EN 61000-3-2:2014	Electromagnetic compatibility (EMC). Limits for harmonic current emissions (equipment input current $\leq 16A$ per phase).
	EN 61000-3-3:2013	Electromagnetic compatibility (EMC). Limitation of voltage changes, voltage fluctuations and flicker in public low- voltage supply systems for equipment with rated current $\leq 16A$ per phase and not subject to conditional connection.
Specifications with which Conformity is Declared:	Electromagnetic Compatibility Directive	
We hereby certify that the machinery described above conforms with the essential requirements of Council Directive 2004/108/EC on the approximation of the laws of the Member States relating to the electromagnetic compatibility.		
Date:		
Signed:		
Signatory:	Mark Cox Director of Engineering	



Declaration of Noise Emission

The Dexter Laundry Commercial Washing System Models Sound Pressure Levels per EN ISO 11202 as measured on similarly constructed models are as follows:

Model WCAD40KCB-59CN	Operating	Idle
L_{pAm} (Operator Position)	64 dB (A)	51 dB (A)
L_{pAm} (Bystander Position)	69 dB (A)	51 dB (A)
<p>Ambient Correction Factor K3A calculated according to EN ISO 11204 Appendix A. 4 dB(A)</p> <p>Measurements were made at a height of 1.5 m and 1 m from the Operator Position and Bystander positions.</p> <p>The difference between the extraneous noise level and the sound intensity level at each measuring point is: $L_{pAm} \Delta = 13 \text{ dB (A)}$</p> <p>The figures quoted are emission levels and are not necessarily safe working levels. While there is a correlation between the emission and exposure levels this cannot be used reliably to determine whether or not further precautions are required.</p> <p>Factors that influence the actual level of exposure of the workforce include characteristics of the work room, the other sources of noise, etc. such as the number of machines and other adjacent processes. Also, the permissible level of exposure can vary from country to country.</p> <p>This information, however, will enable the user of the machine to make a better evaluation of the hazard and risk.</p>		
	Dexter Laundry 2211 West Grimes Avenue Fairfield, IA 52556 USA	